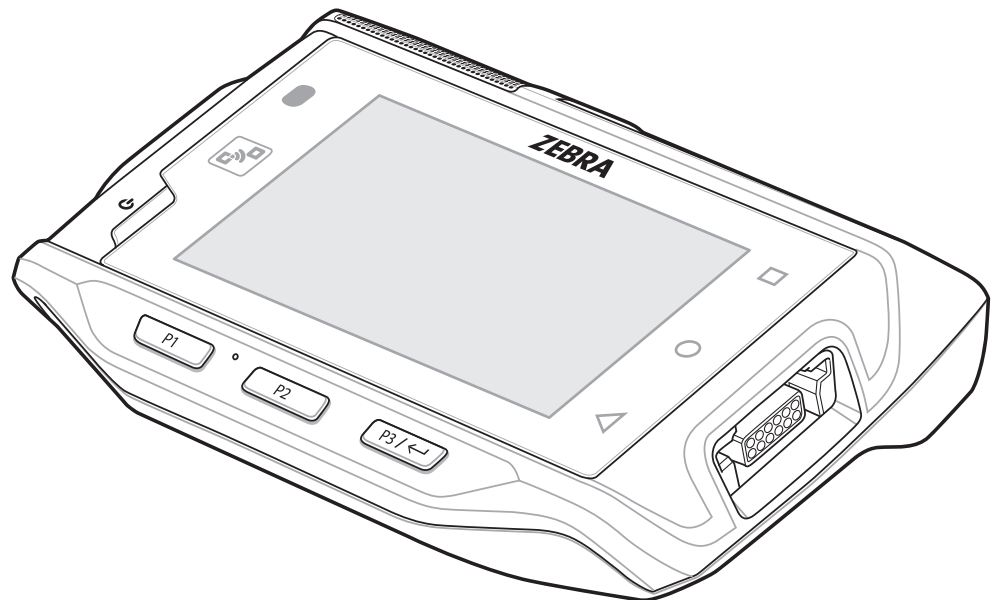


# WT6000

Wearable Computer



**User Guide**  
for Android™ 7.1.1 Nougat



**ZEBRA**

## Copyright

ZEBRA and the stylized Zebra head are trademarks of Zebra Technologies Corporation, registered in many jurisdictions worldwide. Google, Android, Google Play and other marks are trademarks of Google LLC. All other trademarks are the property of their respective owners. ©2019 Zebra Technologies Corporation and/or its affiliates. All rights reserved.

COPYRIGHTS & TRADEMARKS: For complete copyright and trademark information, go to [www.zebra.com/copyright](http://www.zebra.com/copyright).

WARRANTY: For complete warranty information, go to [www.zebra.com/warranty](http://www.zebra.com/warranty).

END USER LICENSE AGREEMENT: For complete EULA information, go to [www.zebra.com/eula](http://www.zebra.com/eula).

## Terms of Use

- Proprietary Statement

This manual contains proprietary information of Zebra Technologies Corporation and its subsidiaries (“Zebra Technologies”). It is intended solely for the information and use of parties operating and maintaining the equipment described herein. Such proprietary information may not be used, reproduced, or disclosed to any other parties for any other purpose without the express, written permission of Zebra Technologies.

- Product Improvements

Continuous improvement of products is a policy of Zebra Technologies. All specifications and designs are subject to change without notice.

- Liability Disclaimer

Zebra Technologies takes steps to ensure that its published Engineering specifications and manuals are correct; however, errors do occur. Zebra Technologies reserves the right to correct any such errors and disclaims liability resulting therefrom.

- Limitation of Liability

In no event shall Zebra Technologies or anyone else involved in the creation, production, or delivery of the accompanying product (including hardware and software) be liable for any damages whatsoever (including, without limitation, consequential damages including loss of business profits, business interruption, or loss of business information) arising out of the use of, the results of use of, or inability to use such product, even if Zebra Technologies has been advised of the possibility of such damages. Some jurisdictions do not allow the exclusion or limitation of incidental or consequential damages, so the above limitation or exclusion may not apply to you.

---

## Revision History

Changes to the original guide are listed below:

Change	Date	Description
-01 Rev A	5/2018	Initial release.
-02 Rev A	7/2018	Include information on extended battery.
-03 Rev A	9/2019	Include information on keypad accessory.

Change	Date	Description
-04 Rev A	10/2019	Update keypad illustrations and descriptions to include back-light icon.
-05 Rev A	11/2019	Update table 7. Only ten special characters are supported.

# Table Of Contents

Revision History .....	2
<b>Table Of Contents .....</b>	<b>4</b>
<b>About This Guide</b>	
Introduction .....	10
Documentation Set .....	10
Software Versions .....	10
Configurations .....	11
Chapter Descriptions .....	11
Notational Conventions .....	12
Related Documents and Software .....	12
Service Information .....	13
Provide Documentation Feedback .....	13
<b>Getting Started</b>	
Introduction .....	14
Unpacking .....	14
Removing the Screen Protection Film .....	14
Features .....	15
Setup .....	16
Installing the Battery .....	16
Charging the Battery .....	17
Starting the WT6000 .....	18
Installing the Wrist Mount .....	19
Connecting a Scanner .....	20
Replacing the Battery .....	20
Accessing Device Settings .....	22
Battery Management .....	23
Monitor Battery Usage .....	23
Low Battery Notification .....	23
Battery Optimization .....	24
Turning Off the Radios .....	24
Setting the Date and Time .....	24
Display Setting .....	25

## Table of Contents

Setting the Screen Brightness .....	25
Setting Screen Rotation .....	25
Setting Screen Timeout Setting .....	25
Setting Key Light Timeout Setting .....	26
Setting Font Size .....	26
Cast .....	26
General Sound Setting .....	27

### Using the WT6000

Introduction .....	29
Home Screen .....	29
Status Bar .....	30
Status Icons .....	30
Notification Icons .....	31
Managing Notifications .....	32
Setting Application Notifications .....	32
Viewing Notification Settings for All Apps .....	33
Controlling Lock Screen Notifications .....	33
Quick Access Panel .....	33
Edit Icons on Quick Settings .....	34
Application Shortcuts and Widgets .....	34
Adding an Application to the Home Screen .....	35
Adding a Widget to the Home Screen .....	35
Moving Items on the Home Screen .....	35
Removing an Application Shortcut or Widget from the Home Screen .....	35
Folders .....	35
Creating a Folder .....	35
Naming Folders .....	35
Removing a Folder .....	36
Home Screen Wallpaper .....	36
Application Shortcuts and Widgets .....	36
Adding an Application or Widget to the Home Screen .....	36
Moving Items on the Home Screen .....	36
Removing an App or Widget from the Home Screen .....	37
Folders .....	37
Using the Touchscreen .....	37
Keyboards .....	38
Keyboard Configuration .....	38
Enabling Keyboards .....	38
Switching Between Android and Enterprise Keyboards .....	38
Selecting the Japanese IME Keyboard .....	38
Using the Enterprise Keyboard .....	38
Numeric Tab .....	38
Alpha Tab .....	39
Scan Tab .....	40
Using the Android Keyboard .....	40
Editing Text .....	40
Entering Numbers, Symbols and Special Characters .....	40
Keypad .....	41
Do Not Disturb Feature .....	43

## Table of Contents

Limit Sounds and Vibrations .....	43
Total Silence .....	43
Alarms Only .....	43
Priority Notifications Only .....	44
Automatically Block Sounds and Vibrations .....	44
Silence Sounds During Certain Times .....	44
Silence Sounds During Events and Meetings .....	45
Turn Sounds Back On .....	45
Override Do Not Disturb for Specific Apps .....	45
Applications .....	45
Accessing Applications .....	48
Switching Between Recent Applications .....	48
Un-Locking the Screen .....	49
Suspend Mode .....	51
Resetting the WT6000 .....	51
Performing a Soft Reset .....	51
Performing a Hard Reset .....	51
Transferring Files with a Host Computer via USB .....	52
Transferring Files using Media Transfer Protocol .....	52
Transferring Files using Photo Transfer Protocol .....	52
Disconnect from the Host Computer .....	53
<b>Data Capture</b>	
Introduction .....	54
Laser Scanning .....	54
Scanning Bar Codes .....	54
Imaging .....	54
Operational Modes .....	55
Scanning Considerations .....	55
Bar Code Capture with RS4000 .....	55
Adaptive Scanning .....	56
Bar Code Capture with RS5,000 Corded Imager .....	56
Bar Code Capture with RS6000 Hands-Free Imager .....	57
Bar Code Capture with RS507 Hands-Free Imager .....	59
Pairing the RS507/RS6000 Hands-Free Imager .....	60
Pairing Using Near Field Communication .....	60
Pairing in HID Mode Using Near Field Communication .....	61
Pairing Using Simple Serial Interface .....	62
Pairing Using Bluetooth Human Interface Device .....	63
<b>Wireless</b>	
Wireless Local Area Networks .....	65
Scan and Connect to a Wi-Fi Network .....	65
Remove a Wi-Fi Network .....	66
Bluetooth .....	67
Adaptive Frequency Hopping .....	67
Security .....	67
Bluetooth Profiles .....	68
Bluetooth Power States .....	68

## Table of Contents

Bluetooth Radio Power .....	68
Enabling Bluetooth .....	69
Disabling Bluetooth .....	69
Discovering Bluetooth Device(s) .....	69
Changing the Bluetooth Name .....	69
Connecting to a Bluetooth Device .....	70
Selecting Profiles on the Bluetooth Device .....	70
Unpairing a Bluetooth Device .....	70
Near Field Communications .....	70
Reading NFC Cards .....	71

### Applications

Introduction .....	73
Battery Manager .....	73
Device Central .....	76
Device Central Tabs .....	76
Paging an RS6000 Ring Scanner .....	76
File Browser .....	78
Contacts .....	79
Adding a Contact .....	79
Editing Contacts .....	79
Deleting Contacts .....	79
Gallery .....	80
Working with Albums .....	80
Share an Album .....	81
Get Album Information .....	81
Deleting an Album .....	81
Working with Photos .....	81
Viewing and Browsing Photos .....	81
Cropping a Photo .....	82
Setting a Photo as a Contact Icon .....	82
Share a Photo .....	83
Deleting a Photo .....	83
Working with Videos .....	83
Watching Videos .....	83
Sharing a Video .....	83
Deleting a Video .....	84
PTT Express Voice Client .....	85
PTT Audible Indicators .....	85
Notification Icons .....	86
Enabling PTT Communication .....	86
Selecting a Talk Group .....	86
PTT Communication .....	87
Creating a Group Call .....	87
Responding with a Private Response .....	87
Disabling PTT Express Voice Client Communication .....	88
DataWedge .....	89
DataWedge Demonstration .....	89
RxLogger .....	90
Enabling Logging .....	90

## Table of Contents

Disabling Logging .....	90
RxLogger Utility .....	91
Diagnostic Tool .....	92
Settings .....	93
Battery Test Information .....	93
GPS Test Information .....	94
System Test Information .....	94
WLAN Test Information .....	94
WWAN Test Information .....	94
Bluetooth Test Information .....	94

### Accessories

Accessories .....	95
1-Slot WT6000 USB Charging Cradle .....	98
Charging the Device .....	98
Charging the Spare Battery .....	99
Battery Charging .....	100
2-Slot WT6000/RS6000 Charging Cradle .....	101
Charging the WT6000 .....	101
Charging the RS6000 .....	102
Battery Charging .....	103
5-Slot WT6000 Charge Only Cradle .....	104
Charging the WT6000 .....	104
Charging the Spare Battery .....	105
Battery Charging .....	106
10-Slot WT6000/RS6000 Charge Only Cradle .....	107
Charging the WT6000 .....	107
Charging the RS6000 .....	108
Battery Charging .....	109
10-Slot WT6000 Charge Only Cradle .....	110
Charging the WT6000 .....	110
Battery Charging .....	111
5-Slot WT6000 Ethernet Cradle .....	112
Charging the WT6000 .....	112
Charging the Spare Battery .....	113
Battery Charging .....	114
Establishing Ethernet Communication .....	114
Ethernet LED Indicators .....	114
4-Slot Battery Charger .....	116
Battery Installation .....	116
Battery Removal .....	117
Battery Charging .....	117
Spare Battery Charging .....	117
20-Slot Battery Charger .....	118
Battery Installation .....	118
Battery Removal .....	119
Battery Charging .....	119
Spare Battery Charging .....	119
USB and Charging Cable .....	120
Attaching the USB and Charging Cable .....	120



## Table of Contents

Removing the USB and Charging Cable .....	121
Battery Charging .....	121
Main Battery Charging .....	121
Charging Temperature .....	121
Keypad .....	122
Installing the Keypad .....	122
Hip Mount .....	124
Routing an Extended Cable Scanner .....	125
Quick Disconnect Audio Cables .....	127
Attaching the Audio Adapter .....	127
Connecting the Audio Cable to a Headset .....	128
Removing the Audio Adapter .....	129
Vibrator Cable .....	130
RS4000 Scanner .....	131
RS5000 Imager .....	133
<b>Maintenance and Troubleshooting</b>	
Introduction .....	135
Maintaining the WT6000 .....	135
Battery Safety Guidelines .....	135
Long Term Storage .....	136
Cleaning Instructions .....	136
Approved Cleanser Active Ingredients .....	136
Harmful Ingredients .....	136
Cleaning Instructions .....	136
Special Cleaning Notes .....	137
Cleaning Materials Required .....	137
Cleaning Frequency .....	137
Cleaning the WT6000 .....	137
Housing .....	137
Display .....	137
Power Connector .....	137
Cleaning Cradle Connectors .....	138
Cleaning the Wrist Mount .....	138
Troubleshooting .....	141
WT6000 .....	141
<b>Specifications</b>	
Technical Specifications .....	143

## Index

# About This Guide

---

## Introduction

This guide provides information about setting up and configuring WT6000 mobile computers with Android operating system and installing its accessories.



**NOTE:** Some screens or windows shown in this guide may differ from the actual screens shown on the WT6000.

---

## Documentation Set

The documentation set for the WT6000 is divided into guides that provide information for specific user needs.

WT6000 documentation includes:



- **WT6000 Quick Reference Guide** - describes basic set up and operation of the WT6000 and it's accessories.
- **WT6000 User Guide** (this guide) - describes how to set up, operate and program the WT6000 with Android operating system and it's accessories.
- **WT6000 Integrator Guide** - describes how to setup and configure WT6000 and accessories.

---

## Software Versions

To determine the current software versions, touch  >  **About device**.

- Model number - Displays the model number.
- Android version - Displays the operating system version.
- Kernel version - Displays the kernel version number.
- Build number - Displays the software build number.

To determine the device serial number, touch  >  **About device** > **Status**.

- Serial number - Displays the serial number.

## Configurations

This guide covers the following configurations:

Configuration	Radios			Data Capture				Display	Keypad	Memory		OS		Sensors		Battery	
	802.11 abgn	Bluetooth 4.0	NFC	RS4000	RS5,000	RS6000	RS507	3.2" WVGA Color	External Keypad	1G RAM/ 4 GB Flash	2G RAM/ 8 GB Flash	Android AOSP V5.1.1	Android AOSP V7.1.1	Accelerometer	Gyroscope	Standard	Extended
Standard																	
WT60A0-TS0LEWR	X	X	X	X	X	X	X	X		X		X		X	X	X	
WT60A0-TS0LEUS	X	X	X	X	X	X	X	X		X		X		X	X	X	
WT60A0-TX0LEWR	X	X	X	X	X	X	X	X		X		X		X	X		X
WT60A0-TX0LEUS	X	X	X	X	X	X	X	X		X		X		X	X		X
Premium																	
WT60A0-TS2NEWR	X	X	X	X	X	X	X	X			X		X	X	X	X	
WT60A0-TS2NEUS	X	X	X	X	X	X	X	X			X		X	X	X	X	
WT60A0-TX2NEWR	X	X	X	X	X	X	X	X			X		X	X	X		X
WT60A0-TX2NEUS	X	X	X	X	X	X	X	X			X		X	X	X		X
Premium																	
WT60A0-KS2NEWR	X	X	X	X	X	X	X	X	X		X		X	X	X	X	
WT60A0-KS2NEUS	X	X	X	X	X	X	X	X	X		X		X	X	X	X	
WT60A0-KX2NEWR	X	X	X	X	X	X	X	X	X		X		X	X	X		X
WT60A0-KX2NEUS	X	X	X	X	X	X	X	X	X		X		X	X	X		X

## Chapter Descriptions

Topics covered in this guide are as follows:

- [Getting Started](#), describes the features and basic operation of the WT6000, lists the accessories for the WT6000 and explains how to install and charge the batteries and start the WT6000 for the first time.
- [Using the WT6000](#), provides instructions for connecting the WT6000 to a host computer and using the OS desktop of the WT6000.
- [Data Capture](#), provides information for capturing bar code data.
- [Wireless](#), provides information on the various wireless options.
- [Applications](#), provides information on various applications pre-installed on the WT6000.
- [Accessories](#), Accessories, provides information for using the accessories with the WT6000.

- [Maintenance and Troubleshooting](#), includes instructions on cleaning and storing the WT6000, and provides troubleshooting solutions for potential problems during WT6000 operation.
- [Specifications](#), includes a table listing the technical specifications for the WT6000 and accessories.

---

## Notational Conventions

The following conventions are used in this document:

- **Bold** text is used to highlight the following:
  - Dialog box, window and screen names
  - Drop-down list and list box names
  - Check box and radio button names
  - Icons on a screen
  - Key names on a keypad
  - Button names on a screen
- Bullets (•) indicate:
  - Action items
  - Lists of alternatives
  - Lists of required steps that are not necessarily sequential
  - Sequential lists (e.g., those that describe step-by-step procedures) appear as numbered lists.



**NOTE:** This symbol indicates something of special interest or importance to the reader. Failure to read the note will not result in physical harm to the reader, equipment or data.



**CAUTION:** This symbol indicates that if this information is ignored, the possibility of data or material damage may occur.



**WARNING:** This symbol indicates that if this information is ignored the possibility that serious personal injury may occur.

---

## Related Documents and Software

The following documents provide more information about the WT6000 touch computers.

- WT6000 Quick Start Guide, p/n MN-002700-xx
- WT6000 Regulatory Guide, p/n MN-002701-xx
- WT6000 Integrator Guide, p/n MN-003227-xx
- WT6000 Accessory Regulatory Guide, p/n MN-002702-xx

For the latest version of this guide and all guides, go to: <http://www.zebra.com/support>.

---

## Service Information

If you have a problem with your equipment, contact Customer Support for your region. Contact information is available at: <http://www.zebra.com/support>.

When contacting Customer Support, please have the following information available:

- Serial number of the unit
- Model number or product name
- Software type and version number.

We respond to calls by E-mail, or telephone within the time limits set forth in support agreements.

If your problem cannot be solved by Zebra Support, you may need to return your equipment for servicing and will be given specific directions. Zebra is not responsible for any damages incurred during shipment if the approved shipping container is not used. Shipping the units improperly can possibly void the warranty.

If you purchased your business product from a business partner, contact that business partner for support.

---

## Provide Documentation Feedback

If you have comments, questions, or suggestions about this guide, send an email to [EVM-Techdocs@zebra.com](mailto:EVM-Techdocs@zebra.com).

# Getting Started

---

## Introduction

This chapter describes the features of the WT6000 and explains how to install and charge the battery and how to reset the WT6000.

## Unpacking

Carefully remove all protective material from the WT6000 and save the shipping container for later storage and shipping.

Verify that box contains all the equipment listed below:

- WT6000
- Battery
- Regulatory Guide.

Inspect the equipment for damage. If you are missing any equipment or if you find any damaged equipment, contact Support immediately. See [Service Information on page 13](#) for contact information.

## Removing the Screen Protection Film

A screen protection film is applied to the WT6000 screen to protect the screen during shipping. To remove the screen protector, carefully lift the thin film off the display.

## Features

Figure 1 Front View

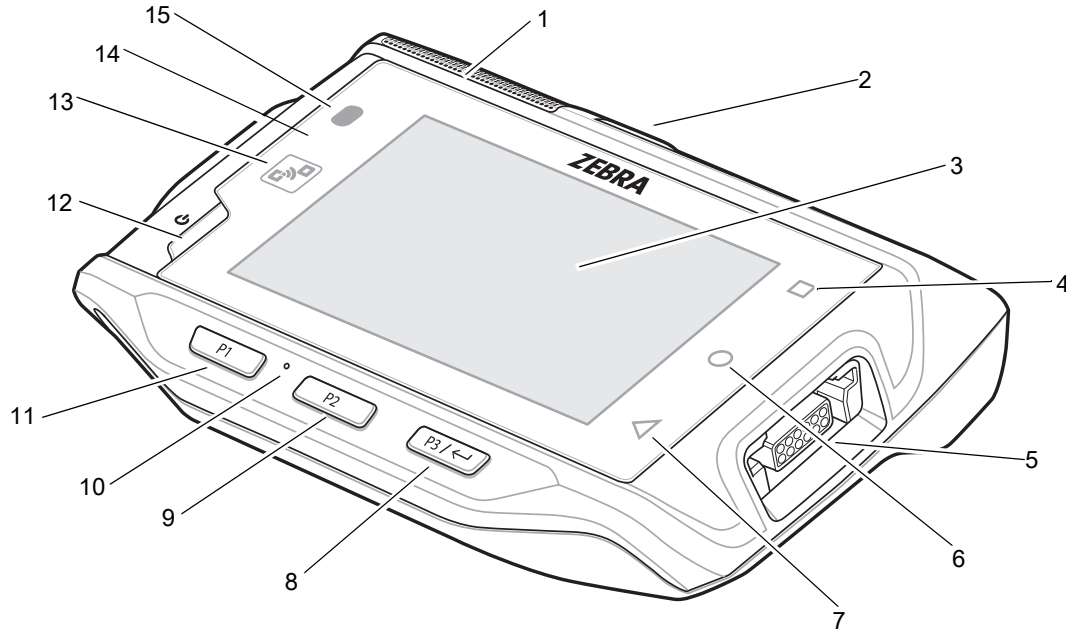


Table 1 Front View Descriptions

Number	Item	Function
1	Speaker	Provides audio output for video and music playback.
2	Battery <sup>1</sup>	Provides power to the device.
3	Display	Displays all information needed to operate the WT6000.
4	Recent Button	Displays recently open applications.
5	Right Interface Connector	Provides USB host and client communication, audio and device charging via cables and accessories.
6	Home Button	Displays the Home screen.
7	Back Button	Displays the previous screen.
8	P3 / Enter Button	Initiates Push-To-Talk communication (programmable). Use as the Enter button when a keypad is attached.
9	P2 Button	Increases volume.
10	Microphone	Use for communication on handset.
11	P1 Button	Decreases volume.
12	Power Button	Turns the display on and off. Press and hold to reset the device and power off.
13	NFC Antenna	Provides communication with other NFC-enabled devices.

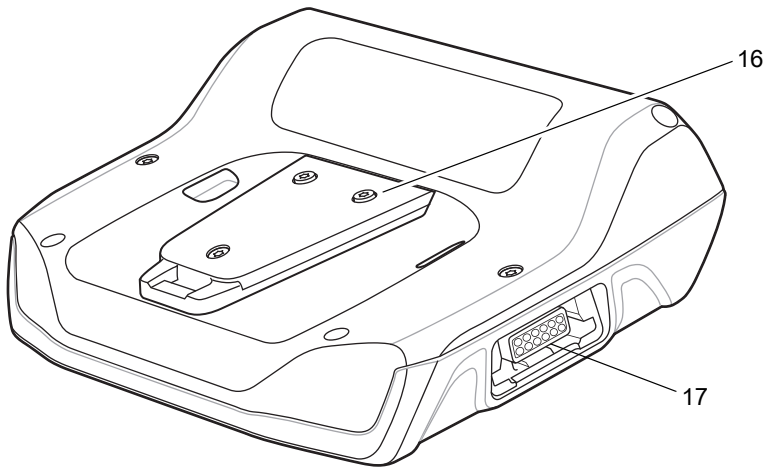
<sup>1</sup> Standard battery is shown.

**Table 1** Front View Descriptions (Continued)

Number	Item	Function
14	Ambient Light Sensor	Determines ambient light for controlling display backlight intensity.
15	Notification/Charge LED	Indicates battery charging status while charging with USB Charge cable and provide notifications from applications.

*! Standard battery is shown.*

**Figure 2** Back View



**Table 2** Back View Descriptions

Number	Item	Function
16	Cleat	Provides alignment and secures the WT6000 to the wrist mount.
17	Left Interface Connector	Provides USB host and client communication, audio and device charging via cables and accessories.

## Setup

Perform these procedures to start using the WT6000 for the first time.

1. Install the battery.
2. Charge the WT6000.
3. Power on the WT6000.

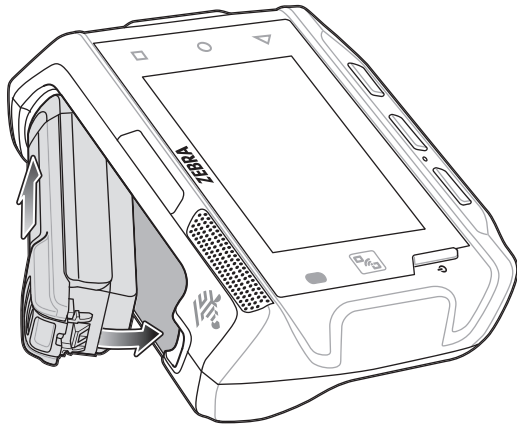
### Installing the Battery

To install the battery:

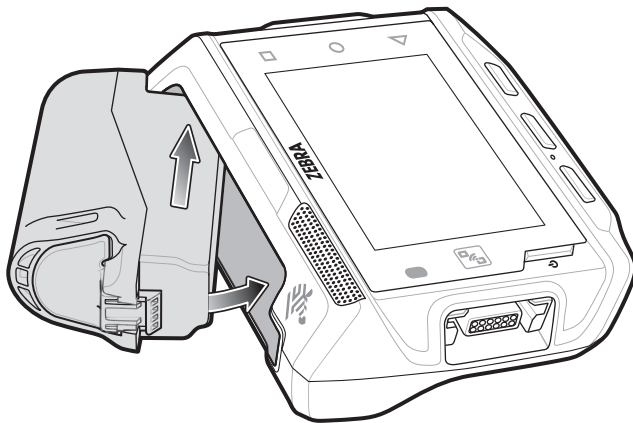
1. Insert the end of the battery into the battery well.



**Figure 3** Standard Battery Installation



**Figure 4** Extended Battery Installation



2. Press the battery down until it snaps into place.

## Charging the Battery

Before using the WT6000 for the first time, charge the battery using a cable or a cradle with the appropriate power supply. For information about the accessories available for the WT6000, see [Accessories](#).

The standard 3,350 mAh battery fully charges in approximately four hours at room temperature. The extended 5,000 mAh battery fully charges in approximately five hours and 30 minutes at room temperature.

Charge batteries in temperatures from 0°C to 40°C (32°F to 104°F). The WT6000 or accessory always performs battery charging in a safe and intelligent manner. At higher temperatures (e.g. approximately +37°C (+98°F)) the WT6000 or accessory may for small periods of time alternately enable and disable battery charging to keep the battery at acceptable temperatures. The WT6000 or accessory indicates when charging is disabled due to abnormal temperatures via its red blinking LED.

1. To charge the main battery, connect the charging accessory to the appropriate power source.
2. Insert the WT6000 into a cradle or attach to a cable. The WT6000 turns on and begins charging.

When using the USB Charge cable, the Notification/Charge LED lights amber while charging, then turns solid green when fully charged.

When using a cradle, the cradle Charge LED lights amber while charging, then turns solid green when fully charged.

**Table 3** Charge LED Charging Indicators

State	Indication
Off	WT6000 is not charging. WT6000 is not inserted correctly in the cradle or connected to a power source. Charger/cradle is not powered.
Solid Amber	Healthy battery is charging.
Solid Green	Healthy battery charging is complete.
Fast Blinking Red (2 blinks/second)	Charging error, e.g.: - Temperature is too low or too high. - Charging has gone on too long without completion (typically eight hours).
Solid Red	Unhealthy battery is charging or fully charged.



**IMPORTANT:** When trying to power on the device, a quick red blink of the Charging LED indicates that it does not have enough battery power to turn on. Charge the battery or replace it.

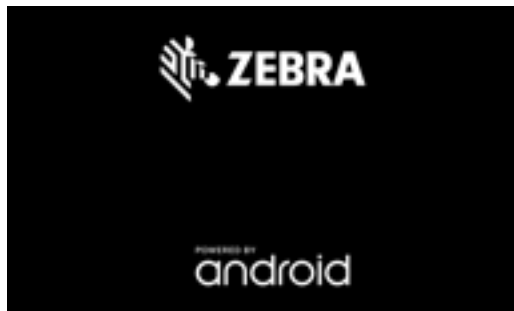
## Starting the WT6000

When installed in a cradle, the WT6000 starts automatically as soon as power is applied.

When a charged battery is installed and the WT6000 is turned off, press the Power button to turn on.

When the WT6000 is powered on for the first time, it initializes its system. The splash screen appears for a short period of time.

**Figure 5** Splash Screen



The splash screen is followed by the boot animation screen and then the **Home Screen**.

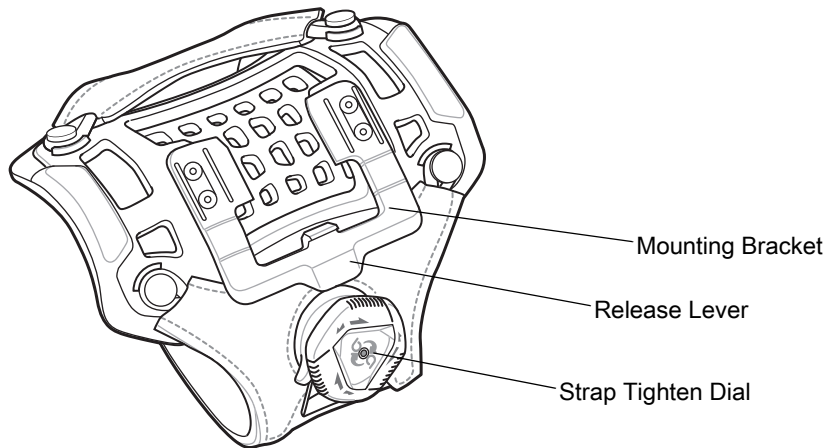
**Figure 6** Home Screen



## Installing the Wrist Mount

The wrist mount provides the mounting of the WT6000 on the forearm for hands-free applications. Refer to the Wrist Mount Installation Guide for information on the wrist mount.

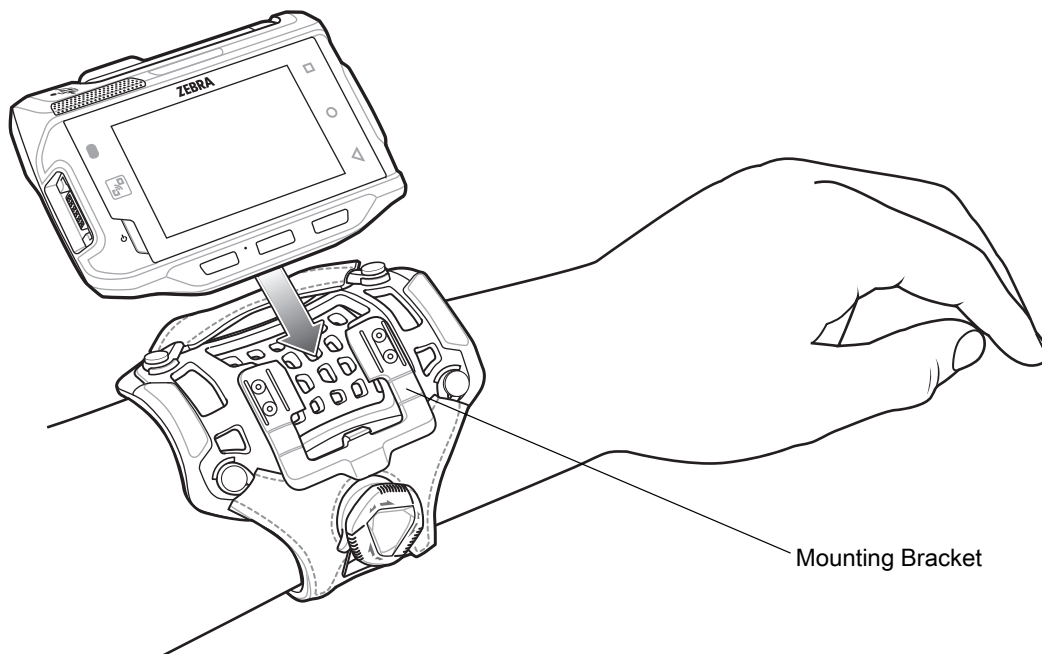
**Figure 7** Wrist Mount



To install the wrist mount:

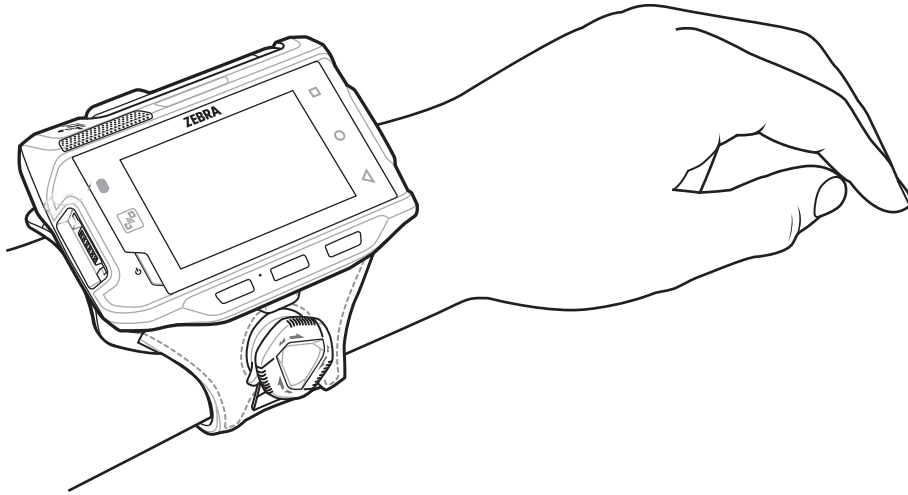
1. Slide the wrist mount onto arm.
2. Position the Install the short strap on the forearm.
3. Turn the dial clockwise to tighten. If too tight, turn counterclockwise to loose slightly.
4. Align the cleat on the back of the WT6000 with the mounting bracket on the wrist mount.

**Figure 8** Aligning the Cleat



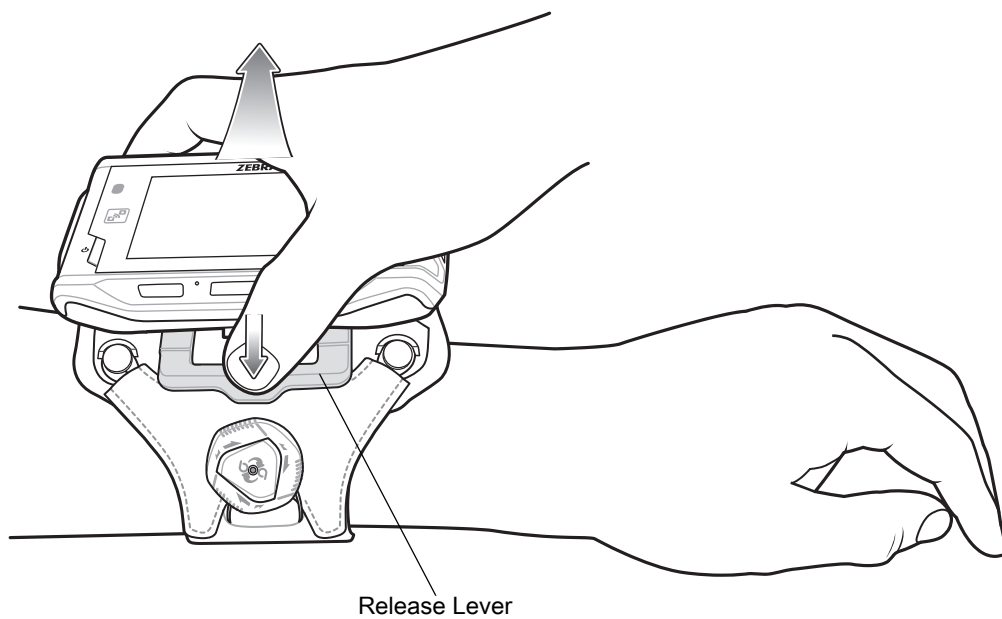
5. Slide the WT6000 onto the wrist mount until it clicks into place.
6. If necessary, use the dial to loosen and re-tighten the strap.

**Figure 9** WT6000 and Wrist Mount



To remove the WT6000 from the wrist mount, press down on the release lever and slide the WT6000 out.

**Figure 10** WT6000 Removal



---

## Connecting a Scanner

The RS4000 scanner and the RS5,000 and RS6000 imagers can be used with the WT6000. See [RS4000 Scanner on page 131](#) for procedures for connecting the scanner to the WT6000. Refer to the RS5,000 Quick Start Guide for procedures for connecting the RS5,000 imager to the WT6000. Refer to the RS6000 Product Reference Guide for procedures for connecting the RS6000 imager to the WT6000.

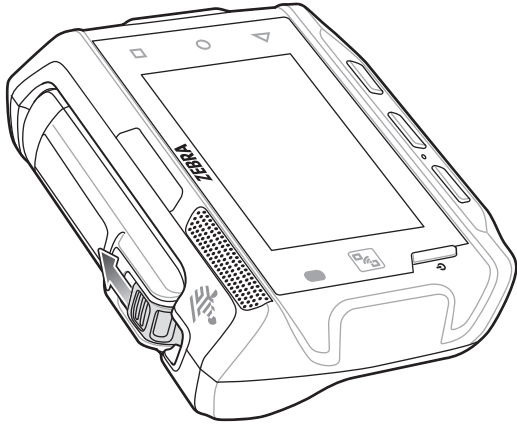
---

## Replacing the Battery

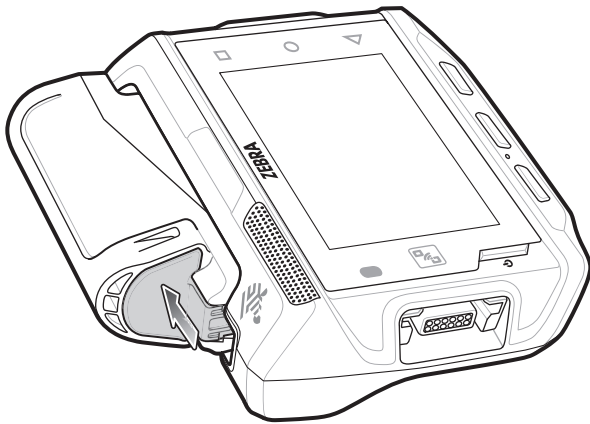
To remove the battery:

1. Press the Power button to place the WT6000 in suspend mode.
2. Using finger tip, press the battery release latch toward the end of the battery.

**Figure 11** Pull Release Latch Back on Standard Battery

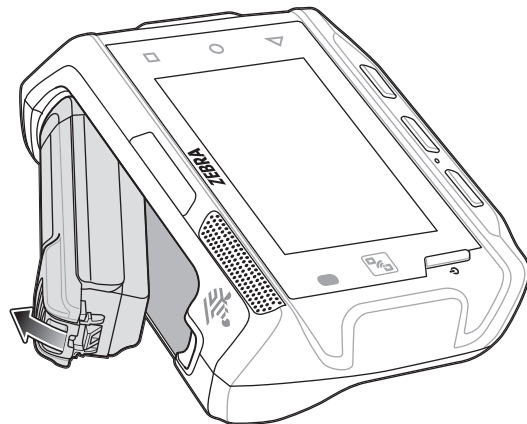


**Figure 12** Pull Release Latch Back on Extended Battery

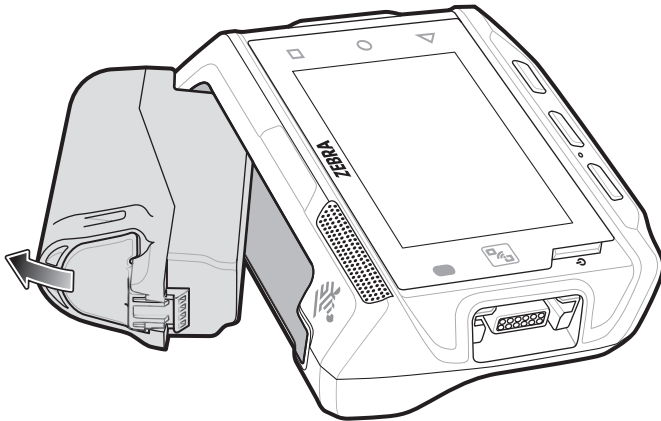


3. Lift the battery out of the battery well.

**Figure 13** Standard Battery Removal

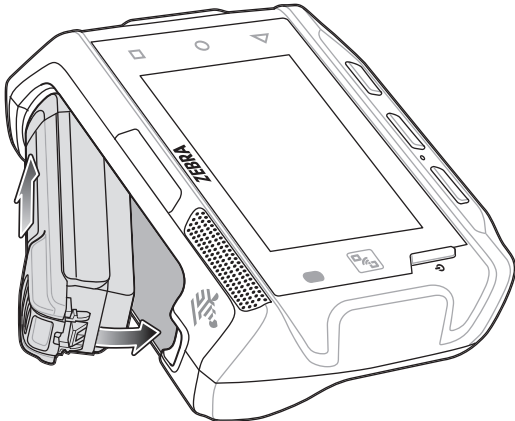


**Figure 14** Extended Battery Removal

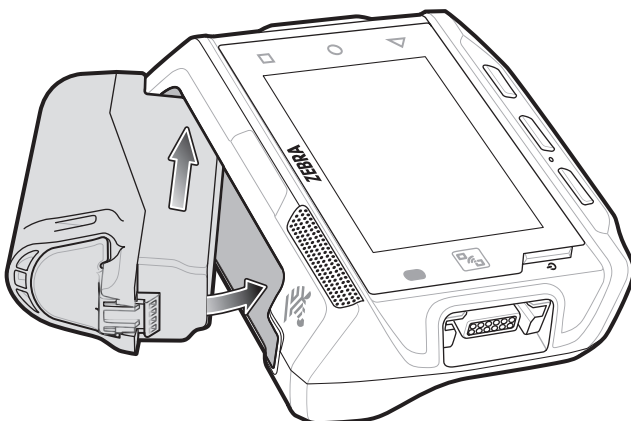


4. Insert the end of the battery into the battery well.

**Figure 15** Standard Battery Installation



**Figure 16** Extended Battery Installation





5. Press the battery down until it snaps into place.

---

## Accessing Device Settings

Throughout this guide, the user can access device settings:

- Swipe down from the status bar to open the quick settings bar and then touch .
- On the Home screen, swipe up from the bottom of the screen and touch .

---

## Battery Management

- ✓ **NOTE:** Prior to checking the battery charge level, remove the WT6000 from any AC power source (cradle or cable).

To check the charge status of the main battery, open Settings and touch  **About device** > **Status**.

**Battery status** indicates that the battery is discharging (not charging) and **Battery level** lists the battery charge (as a percentage of fully charged). The battery percentage can also be viewed under the battery icon in the quick access panel. Swipe down with two fingers from the status bar to open the quick settings panel.

## Monitor Battery Usage

The **Battery** screen lists which applications consume the most battery power. Also use it to turn off applications that were downloaded if they are consuming too much power.

Swipe down from the status bar to open the quick settings bar and then touch  >  **Battery**.

**Figure 17** Battery Screen



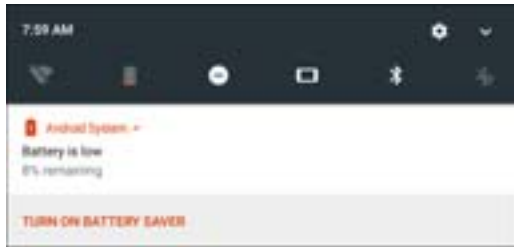
The Battery screen lists the applications using the battery. The discharge graph at the top of the screen shows the rate of the battery discharge since last charged (short periods of time when connected to a charger are shown as thin green lines at the bottom of the chart), and how long it has been running on battery power.

Touch an application in the Battery screen to display details about its power consumption. Different applications display different information. Some applications include buttons that open screens with settings to adjust power use.

## Low Battery Notification

When the battery charge level drops below 15%, the WT6000 displays a notice to connect the WT6000 to power. Place the WT6000 into a cradle to charge the battery.

**Figure 18** Low Battery Notification



When the battery charge drops below 10%, the WT6000 displays a notice to connect the WT6000 to power. The user must charge the battery using one of the charging accessories.

When the battery charge drops below 5%, the WT6000 turns off. Place the WT6000 into a cradle to charge the battery.

## Battery Optimization


Observe the following battery saving tips:

- Set the screen to turn off after a short period of non-use. See [Setting Screen Timeout Setting on page 25](#).
- Reduce screen brightness. See [Setting the Screen Brightness on page 25](#).
- Turn off all wireless radios when not in use.
- Turn off automatic syncing for Email, Calendar, Contacts and other applications.
- Use the Power Control widget to check and control the status of radios, the screen brightness, and syncing.
- Minimize use of applications that keep the WT6000 from suspending, for example, music and video applications.

## Turning Off the Radios

To turn off all the radios:



✓ **NOTE:** Alternately, you can place the device into **Airplane mode** using the **Quick Settings** option.

1. Press the power button until the menu appears.
2. Touch **Airplane mode**. The airplane icon  appears in the Status bar indicating that all the radios are off.


---

## Setting the Date and Time

The date and time is automatically synchronized using a NTP server when the WT6000 is connected to a Wi-Fi network. To manually change the date and time:

1. Swipe down from the status bar to open the quick settings bar and then touch .
2. Touch  **Date & time**.
3. Touch **Automatic date & time** to disable automatic date and time synchronization.
4. Touch **Set date**.
5. Move the sliders up and down to select the month, date and year.



6. Touch **Done**.
7. Touch **Set time**.
8. Move the sliders up and down to select the hour, minutes and part of the day.
9. Touch **Done**.
10. Touch **Select time zone**.
11. Select the current time zone from the list.
12. Touch .

---

## Display Setting

Use Display settings to change the screen brightness, set sleep time and change font size.

### Setting the Screen Brightness




To manually set the screen brightness:

1. Swipe down with two fingers from the status bar to open the quick settings panel.
2. Slide the icon to adjust the screen brightness level.


**Figure 19** Brightness Dialog Box



To automatically set the screen brightness:



1. Swipe down from the status bar to open the quick settings bar and then touch .
2. Touch  **Display**.
3. If disabled, touch **Adaptive brightness** to automatically adjust the brightness. The control switch moves to the right and turns green indicating the option is enabled.
4. Touch .


### Setting Screen Rotation

By default, screen rotation is disabled. To enable screen rotation, swipe down from the status bar to open the quick settings bar and touch .

### Setting Screen Timeout Setting




To set the screen sleep time:

1. Swipe down from the status bar to open the quick settings bar and then touch .
2. Touch  **Display > Sleep**.
3. Select one of the sleep values.
  - **15 seconds**
  - **30 seconds**
  - **1 minute** (default)

- **2 minutes**
  - **5 minutes**
  - **10 minutes**
  - **30 minutes.**
4. Touch .




### Setting Key Light Timeout Setting

To set the key light sleep time:

1. Swipe down from the status bar to open the quick settings bar and then touch .
2. Touch  **Display > Key light timeout setting.**
3. Select one of the sleep values.
  - **Always on**
  - **6 seconds** (default)
  - **10 seconds**
  - **15 seconds**
  - **30 seconds**
  - **1 minute.**
4. Touch .




### Setting Font Size

To set the size of the font in system applications:

1. Swipe down from the status bar to open the quick settings bar and then touch .
2. Touch  **Display > Font size.**
3. Select one of the font size values.
  - Small
  - **Default** (default)
  - Large
  - Largest.
4. Touch .

### Cast


Use **Cast** to mirror the WT6000 screen on a Miracast enabled wireless display.

1. Swipe down from the status bar to open the quick settings bar and then touch .
2. Touch  **Display > Cast.**
4. Touch  **> Enable wireless display.** The WT6000 searches for nearby Miracast devices and lists them.
5. Touch a device to begin casting.

6. Touch .

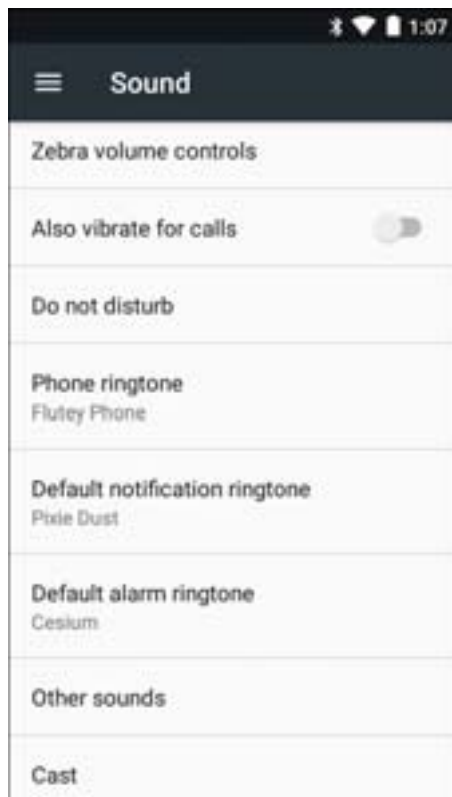
## General Sound Setting

Use the **Sound** settings to configure media, alarm, and ring volumes, and to set notifications.




Swipe down from the status bar to open the quick settings bar and then touch .

Touch  **Sound**.

**Figure 20** Sound Screen



### Zebra volume controls

- **Ring volume** - Controls the ringtone volume.
- **Media volume** - Controls the music, games and media volume.
- **Alarm volume** - Controls the alarm clock volume.
- **Notifications volume** - Controls the notification volume.
- **Scanner volume** - Controls the scanner volume.
-  - Mutes the ring, notifications and scanner so that the device does not make sounds or vibrate.
-  - All sounds except media and alarms are silenced and vibrate mode is active.
-  - Enables all sounds at the user defined levels.

**Also vibrate for calls** - Turn on the switch to make the device vibrate when a call is received (default – disabled).

**Do not disturb** - Mutes the device so that it does not make sounds or vibrate when you do not want it to.

- **Priority only allows** - Use to set priorities.
  - **Alarms** - Disabled.
  - **Reminders and Events** - Switch on or off.
  - **Messages** - Choose from anyone, starred contacts, any contact, or none. To star contacts, use the Contacts app.
  - **Calls** - Choose from anyone, any contacts, starred contacts, or none. To star contacts, use the Contacts app.
  - **Repeat callers** - Choose whether to let the device ring if the same person calls again within 15 minutes.
- **Automatic rules** - To automatically silence the device during certain times, like at night or on weekends. Touch a default rule Weekend or Weeknight. Or, to make your own rule, tap Add rule and then Time rule.
- **Block visual disturbances**
  - **Block when screen is on** - option pertains to notifications you receive when you are actively using the device. If you would like to disable the banner like notifications when Do not Disturb is enabled, turn this option On. This will also prevent you from peeking at notifications.
  - **Block when screen is off** - option pertains to notifications you receive when you are not using your device i.e. the display is asleep. If you want to prevent the display from waking up when a new notification is received, turn this option On. This will additionally disable the LED light alerts your phone sends you when you have new notifications.

**Phone ringtone** - Touch to select a sound to play for incoming calls.

**Default notification ringtone** - Touch to select a sound to play for all system notifications.

**Default alarm ringtone** - Touch to select a sound to play for alarms.

### Other sounds

- **Dial pad tones** - Play a sound when pressing keys on dial pad (default - disabled).
- **Screen locking sounds** - Play a sound when locking and unlocking the screen (default – enabled).
- **Charging sounds** - Play a sound when inserting and removing the device from a charger. (default – enabled)
- **Touch sounds** - Play a sound when making screen selections (default – enabled).
- **Vibrate on tap** - Device vibrates when making screen selections (default – disabled).

# Using the WT6000

---

## Introduction

This chapter describes the screens, status and notification icons, and controls on the WT6000, and provides basic instructions for using the WT6000.

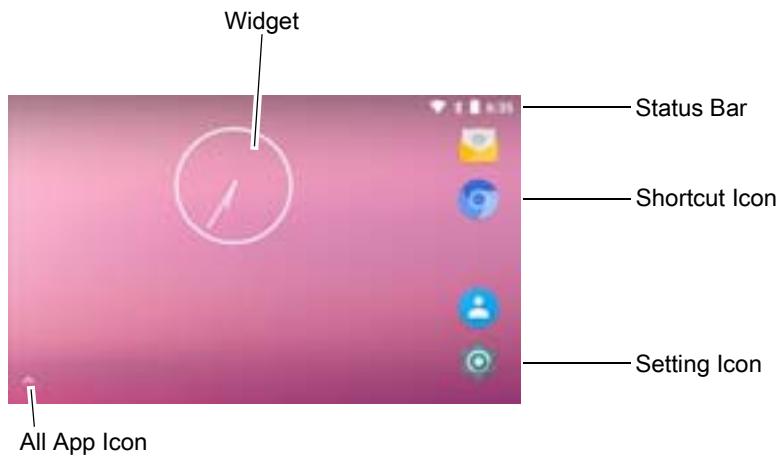
---

## Home Screen

The Home screen displays when the WT6000 turns on. Depending upon the configuration, the Home screen might appear different. Contact your system administrator for more information.

After a suspend or screen time-out, the Home screen displays with the lock sliders. Slide to the right toward to unlock the screen. For screen locking information see [Un-Locking the Screen on page 49](#).

**Figure 21** Home Screen




**NOTE:** The Home screen icons can be configured by the user and may look different than shown.

The Home screen provides four additional screens for placement of widgets and shortcuts. Swipe the screen left or right to view the additional screens.
















## Status Bar

The Status bar displays the time, notification icons (left side) and status icons (right side).



If there are more notifications than can fit in the Status bar,  displays indicating that more notifications exist. Open the Notifications panel to view all notifications and status.

### Status Icons

**Table 4** Status Icons



















Icon	Description
	Indicates that the Alarm is active.
	Indicates that the battery is fully charged.
	Indicates that the battery is partially drained.
	Indicates that the battery charge is low.
	Indicates that the battery charge is very low.
	Indicates that the battery is charging.
	Indicates that all sounds except media and alarms are silenced and vibrate mode is active.
	Indicates that the Airplane Mode is active. All radios are turned off.
	Indicates that Bluetooth is on.
	Connected to a Wi-Fi network.
	Not connected to a Wi-Fi network or no Wi-Fi signal.
	Connected to an Ethernet network.
	Indicates that the Orange key is locked.
	Indicates that the Blue key is pressed.
<b>A</b>	Indicates that the ALT key is pressed.
<b>C</b>	Indicates that the CTRL key is pressed.
	Indicates that the Shift key is pressed.

**Table 4** Status Icons (Continued)



Icon	Description
	Indicates that the Shift key is locked.
	Indicates that the Blue Key and SHIFT key are pressed enabling CAPSLOCK.

## Notification Icons

**Table 5** Notification Icons

Icon	Description
	Indicates battery is low.
	Indicates that more notifications are available for viewing.
	Indicates that data is syncing.
	Indicates an upcoming event.
	Indicates that an open Wi-Fi network is available.
	Indicates that a song is playing.
	Indicates that a problem with sign-in or sync has occurred.
	Indicates that the WT6000 is uploading data.
	Indicates that the WT6000 is downloading data when animated and download is complete when static.
	Indicates that the WT6000 is connected via USB cable.
	Indicates that the WT6000 is connected to or disconnected from virtual private network (VPN).
	Preparing Internal Storage.
	Indicates that USB debugging is enabled on the WT6000.
	Headset audio cable is connected to the WT6000.
	Indicates that the WT6000 is connected to a cable or cradle.
	Indicates that the WT6000 is connected to a wireless hands-free imager.
	Indicates that the WT6000 is connected to a corded hands-free imager.
	Indicates the RS507 or RS6000 is connected to the device in HID mode.

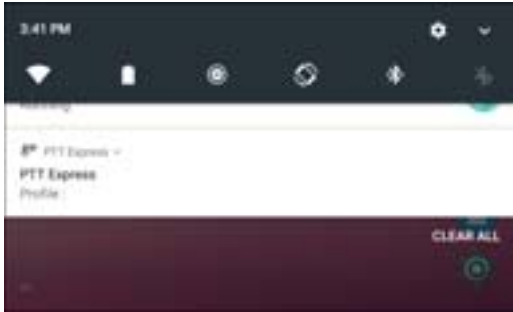
**Table 5** Notification Icons (Continued)

Icon	Description
	Indicates that the RxLogger application is running and capturing data.
	Indicates PTT Express is active. See NEED LINK for more information.

## Managing Notifications

Notification icons report the arrival of new messages, calendar events, and alarms, as well as ongoing events. When a notification occurs, an icon may appear in the Status bar with a brief description. See [Notification Icons on page 31](#) for a list of possible notification icons and their description. Open the Notifications panel to view a list of all the notifications.

To open the Notification panel, drag the Status bar down from the top of the screen.

**Figure 22** Notification Panel

The WT6000 provides notifications when the user connects an accessory or cables into the interface connectors. The notification lists the connector and the type of cable.



To respond to a notification, open the Notifications Panel and then touch a notification. The Notifications Panel closes and the subsequent activity is dependent on the notification.

To clear all notifications, open the Notifications Panel and then touch **CLEAR ALL**. All event-based notifications are removed. Ongoing notifications remain in the list.


To close the Notification Panel, swipe the Notifications Panel up.

## Setting Application Notifications



To change notification settings for a specific app:

1. Swipe down from the status bar to open the notification panel and then touch .
2. Touch  **Notifications**.
3. Select an application.
4. Select an available option:
  - **Block all** - Never show notifications from this application.
  - **Show silently** - Do not allow notifications from this application to make sound, vibrate or peek into view.
  - **Override Do Not Disturb** - Allow these notifications to interrupt when Do Not Disturb is set to Priority Only.






✓ **NOTE:** In the notification, slide the notification slightly left or right and touch .

## Viewing Notification Settings for All Apps

1. Swipe down from the status bar to open the notification panel and then touch .
2. Touch  **Notifications**.
3. Touch down-arrow next to **All apps**.
4. To see all the apps currently set to a specific setting, touch that setting.

## Controlling Lock Screen Notifications

To control whether notifications can be seen when the device is locked.

1. Swipe down from the status bar to open the notification panel and then touch .
2. Touch  **Notifications**.
3. Touch  > **On the lock screen** and select one of the following:
  - **Show all notification content** (default)
  - **Don't show notifications at all**.

## Quick Access Panel

Use Quick Settings to get to frequently used settings, like turning on airplane mode. To open the Quick Settings bar, swipe down once from the top of an unlocked screen.

**Figure 23** Quick Settings Bar



To see the full Quick Settings panel:

- If the WT6000 is locked, swipe down once.
- If the WT6000 is unlocked, swipe down once with two fingers, or twice with one finger.
- If the Quick Settings bar is open, touch the Down arrow.

**Figure 24** Quick Access Panel



To change a setting, just touch the icon from the Quick Settings panel:



- **Display brightness:** Slide to lower or increase the brightness of the screen.

- Wi-Fi network: Turn Wi-Fi on or off. To open Wi-Fi settings, touch the Wi-Fi network name.
- Bluetooth settings: Turn Bluetooth on or off. To open Bluetooth settings, touch the **Bluetooth** icon.
- Battery Power - Indicates percentage of battery power remaining. Touch to view battery usage.
- Invert colors - Invert the display colors.
- Do not disturb: Control how and when to receive notifications.
- Airplane mode: Turn airplane mode on or off. Airplane mode means device will not connect to Wi-Fi or Bluetooth.
- Auto-rotate: Lock the device's orientation in portrait or landscape mode or set to automatically rotate.
- Data Saver - Turn on to prevent some apps from sending or receiving data in the background.
- Hotspot - Not supported.
- Cast - Turn on to mirror the WT6000 screen on a Miracast enabled wireless display



### Edit Icons on Quick Settings

The first several setting tiles become the Quick Settings bar.



To move a setting tile:

1. Open Quick Settings panel.
2. Touch .
3. Touch and drag a setting tile to another location.
4. Release the tile.
5. Touch  to save tiles and return to quick settings.

To add a setting tile:

1. Open Quick Settings panel.
2. Touch .
3. Slide Quick Settings panel up to reveal additional tiles.
4. Touch and drag a setting tile from the Drag to add tiles area to the main area.
5. Release the tile.
6. Touch  to save tiles and return to quick settings.

To remove a setting tile:

1. Open Quick Settings.
2. Touch .
3. Touch and drag a setting tile to the Drag here to remove area.
4. Release the tile.
5. Touch  to save tiles and return to quick settings.

### Application Shortcuts and Widgets

Application shortcuts placed on the Home screen allow quick and easy access to applications. Application Widgets are self-contained applications placed on the Home screen to access frequently used features.

### **Adding an Application to the Home Screen**

1. Go to the desired Home screen.
2. Swipe up from the bottom of the screen.
3. Scroll through the list to find the application icon.
4. Touch and hold the icon until the Home screen appears.
5. Position the icon on the screen and then release.

### **Adding a Widget to the Home Screen**

To add a widget to the Home screen:

1. Go to the desired Home screen.
2. Touch and hold until the menu appears.
3. Touch **WIDGETS**.
4. Scroll through the list to find the widget.
5. Touch and hold the widget until the Home screen appears.
6. Position the widget on the screen and then release.

### **Moving Items on the Home Screen**

1. Touch and hold the item until it floats on the screen.
2. Drag the item to a new location. Pause at the edge of the screen to drag the item onto an adjacent Home screen.
3. Lift finger to place the item on the Home screen.

### **Removing an Application Shortcut or Widget from the Home Screen**

1. Go to the desired Home screen.
2. Touch and hold the application shortcut or widget icon until it floats on the screen.
3. Drag the icon to on the top of the screen and then release.

## **Folders**

Use Folders to organize similar applications together. Tap the folder to open and display items in the folder.

### **Creating a Folder**

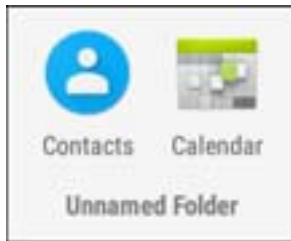
To create a folder, there must be at least two app icons on the Home screen.


1. Go to the desired Home screen.
2. Touch and hold on one application icon.
3. Drag the icon and stack on top of another icon.
4. Lift and release.

### **Naming Folders**

To name a folder:


1. Touch the folder.

**Figure 25** Figure 26 Open Folder

2. Touch the title area and enter a folder name using the keyboard.
3. Touch  on the keyboard.
4. Touch anywhere on the Home screen to close the folder. The folder name appears under the folder.

### Removing a Folder

To remove a folder:

1. Touch and hold the folder icon.
2. Drag the folder to  Remove and release.

### Home Screen Wallpaper


To change the Home screen wallpaper:

1. Touch and hold on the screen until the menu appears.
2. Touch **WALLPAPERS**.
3. Touch **My photos** to select a photo from Gallery or select one of the pre-installed photos.
4. Touch **Set wallpaper**.

### Application Shortcuts and Widgets

Application shortcuts placed on the Home screen allow quick and easy access to applications. Widgets are self-contained applications placed on the Home screen to access frequently used features.


#### Adding an Application or Widget to the Home Screen

1. Go to the desired Home screen.
2. Touch .
3. Swipe right, if necessary, to find the application icon or widget.
4. Touch and hold the icon or widget until the Home screen appears.
5. Position the icon on the screen and then release.

#### Moving Items on the Home Screen

1. Touch and hold the item until it floats on the screen.
2. Drag the item to a new location. Pause at the edge of the screen to drag the item onto an adjacent Home screen.
3. Lift finger to place the item on the Home screen.

### Removing an App or Widget from the Home Screen

1. Go to the desired Home screen.
2. Touch and hold the application shortcut or widget icon until it floats on the screen.
3. Drag the icon to  **Remove** on the top of the screen and then release.

### Folders

Use Folders to organize similar applications together. Tap the folder to open and display items in the folder.

---

## Using the Touchscreen

Use the multi-tap sensitive screen to operate the device.

- **Tap** - Tap to:
  - select items on the screen
  - type letters and symbols using the on-screen keyboard
  - press on-screen buttons.
- **Tap and Hold** - Tap and hold:
  - an item on the Home screen to move it to a new location or to the trash.
  - an item in Apps to create a shortcut on the Home screen.
  - the Home screen to open a menu for customizing the Home screen.
  - an empty area on the Home screen until the menu appears.
- **Drag** - Tap and hold an item for a moment and then move finger on the screen until reaching the new position.
- **Swipe** - Move finger up and down or left and right on the screen to:
  - unlock the screen
  - view additional Home screens
  - view additional application icons in the Launcher window
  - view more information on an application's screen.
- **Double-tap** - Tap twice on a web page, map, or other screen to zoom in and out.
- **Pinch** - In some applications, zoom in and out by placing two fingers on the screen and pinching them together (to zoom out) or spreading them apart (to zoom in).

## Keyboards

The device provides the following types of keyboards:



- Android Keyboard
- Enterprise Keyboard
- Japanese IME





**NOTE:** By default the Enterprise and Japanese IME keyboards are disabled.

## Keyboard Configuration



### Enabling Keyboards

1. Swipe down from the status bar to open the quick settings bar and then touch .
2. Touch  **Languages & input > Virtual keyboard > Manage keyboards.**
3. Slide the keyboard switch to the On position to enable.

### Switching Between Android and Enterprise Keyboards

1. Touch in a text box to display the current keyboard.
2. On the Enterprise keyboard, touch  or on the Android keyboard, touch .

### Selecting the Japanese IME Keyboard

1. Touch in a text box to display the current keyboard.
2. Press and hold  or  and select Japanese IME.

## Using the Enterprise Keyboard

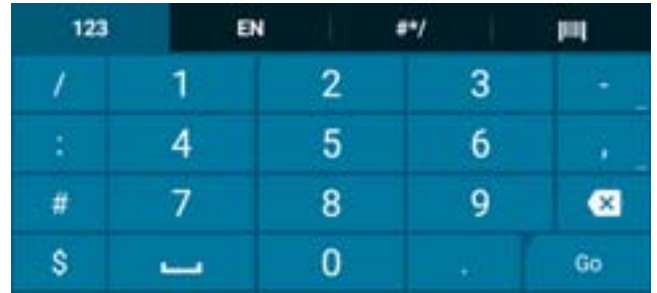
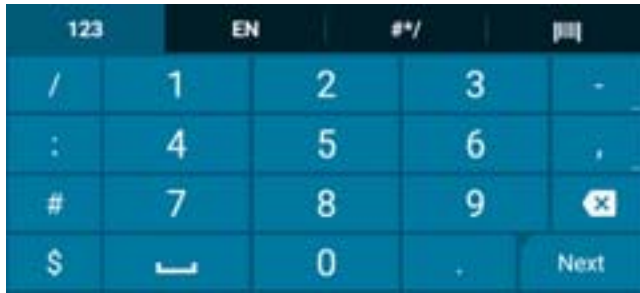
The Enterprise Keyboard contains the following keyboards:

- Numeric
- Alpha
- Special characters
- Data capture.

### Numeric Tab

To access the numeric keyboard, touch the **123** tab. The keys displayed vary on the application being used. For example, an arrow displays in **Contacts**, however **Done** displays in **Email** account setup.

**Figure 26** Numeric Keyboard



### Alpha Tab

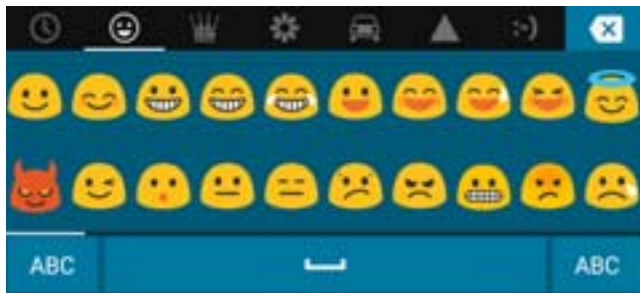
To access the alpha keyboard, touch the EN tab.

**Figure 27** Alpha Keyboard



Touch to enter 😊 emoji icons in a text message.

**Figure 28** Emoji Keyboard



Touch **ABC** to return to the Alpha keyboard.

## Additional Character Tab

To access additional characters, touch the **#/** tab.

**Figure 29** Symbols Keyboard



## Scan Tab

The Scan tab provides an easy data capture feature for scanning barcodes.

**Figure 30** Scan Keyboard



## Using the Android Keyboard

Use the Android keyboard to enter text in a text field. To configure the keyboard settings, touch and hold / (forward slash) and then select **Android keyboard settings**.

### Editing Text

Edit entered text and use menu commands to cut, copy, and paste text within or across applications. Some applications do not support editing some or all of the text they display; others may offer their own way to select text.

### Entering Numbers, Symbols and Special Characters

To enter numbers and symbols:

- Touch and hold one of the top-row keys until a menu appears then select a number or special character.
- Touch the Shift key once for a single capital letter. Touch the Shift key twice to lock in uppercase. Touch the Shift key a third time to unlock Capslock.
- Touch **?123** to switch to the numbers and symbols keyboard.
- Touch the **=\<** key on the numbers and symbols keyboard to view additional symbols.

To enter special characters, touch and hold a number or symbol key to open a menu of additional symbols.

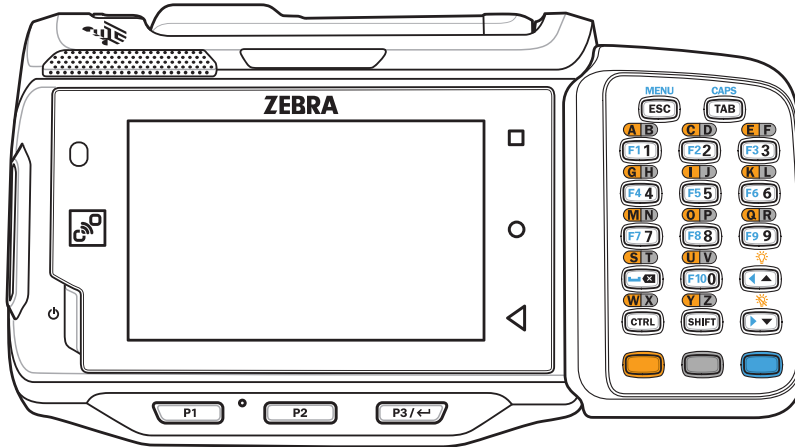
- A larger version of the key displays briefly over the keyboard.
- Keys with alternate characters display an ellipsis ( ... ) below the character.



## Keypad

The alphanumeric keypad accessory contains scroll keys and function keys. The keypad is color-coded to indicate the alternate function keys (blue, orange and gray). Note that keypad functions can be changed by an application, so the wearable terminal's keypad may not function exactly as described.





**Figure 31** Keypad



**Table 6** Alphanumeric Keypad Descriptions

Key	Description
Orange	Press and release the Orange key to activate alphabetic characters (shown on the keypad in orange). The orange icon appears in the Status bar.
Gray	Press and release the Gray key to activate alphabetic characters (shown on the keypad in gray). The gray icon appears in the Status bar.
Blue	Press and release the Blue key to activate the keypad alternate functions (shown on the keypad in blue). The blue icon appears in the Status bar.
Scroll Keys	Moves up or down from one item to another or increases/decreases specified values. Moves left or right from one item to another when used with the Blue key. For each left or right scroll, the Blue key must be pressed first.
ESC	Exits the current operation.
Alphanumeric	In default state, produces the numeric value on the key. In Left Alpha state, produces the lower case alphabetic characters in the orange area. In Right Alpha state, produces the lower case alphabetic characters in the gray area. When the CAPS key is pressed in the Alpha state, the upper case alphabetic characters on the key are produced. For example, press and release the Orange key, press and release the CAPS key and then press the 4 key once to produce the letter 'G'.
CTRL (Control)	Press and release the CTRL key to activate the keypad alternate CTRL functions. The CTRL icon appears in the Status bar. Press the Blue key followed by the CTRL key to activate the keypad alternate ALT functions. The ALT icon appears in the Status bar.
SHIFT	Press and release the SHIFT key to activate the keypad alternate SHIFT functions. The arrow icon appears in the Status bar.

**Table 6** Alphanumeric Keypad Descriptions (Continued)

Key	Description
ENTER	Executes a selected item or function.
TAB	Move the focus to the next field in a window.
MENU	Press and release Blue key, then press and release the MENU key to display the menu on the current screen.
CAPS	Press and release Blue key, then press and release the CAPS key to activate upper case alphabetic characters.
	Backspace function.
	Space function when used with the Blue key.
	Enables the backlight when used with the Orange key.
	Disables the backlight when used with the Orange key.

The keypad is color-coded to indicate the alternate function key (blue) values and the alternate ALPHA key (orange) values. See [Table 7](#) for the special character generation.

**Table 7** Special Character Generation Map

Special Character	Keypad
! (exclamation point)	Shift - 1
@ (at sign)	Shift - 2
# (Pound sign)	Shift - 3
\$ (dollar sign)	Shift - 4
% (percent sign)	Shift - 5
^ (carat)	Shift - 6
& (ampersand)	Shift - 7
* (asterisk)	Shift - 8

**Table 7** Special Character Generation Map (Continued)

Special Character	Keypad
( (open parenthesis)	<b>Shift - 9</b>
) (close parenthesis)	<b>Shift - 0</b>

## Do Not Disturb Feature

This mode mutes the WT6000 so that it does not make sounds or vibrate.

For example, use Do Not Disturb to:

- Automatically limit sounds at night or during events
- Mute interruptions other than alarms
- Get alerted to messages only from favorite contacts.

## Limit Sounds and Vibrations

Mute the WT6000 completely, or let through the important alarms or important calls.

### Total Silence


To completely mute the WT6000 so that it does not make a sound or vibrate, choose **Total silence**.

In Total silence mode:

- Alarms do not make noise.
- WT6000 does not vibrate or make sounds when receiving a message, or notification.
- Sounds from music, videos, games, and other media are muted.

✓ **NOTE:** The user will not hear alarms in Total silence mode.

1. Swipe down with two fingers from the status bar to open the quick access panel.
2. Touch **Do not disturb > Total silence**.
3. Choose **Until you turn it off** or select a time period.
4. Touch **Done**.

When Total Silence is on,  appears in the quick access panel and the Status Bar.


To turn off Total Silence, open quick access panel and touch **Total silence**.

### Alarms Only

To mute the WT6000 so that the user hears alarms, choose **Alarms only**. This option does not mute sounds from music, videos, games, or other media.

1. Swipe down with two fingers from the status bar to open the quick access panel.
2. Touch **Do not disturb > Alarms only**.

3. Choose **Until you turn it off** or select a time period.
4. Tap **Done**.

When Alarms Only is on,  appears in the quick access panel and the Status Bar.

To turn off Alarms Only, open quick access panel and touch **Alarms only**.





**NOTE:** To quickly turn on Alarms Only, with the screen on, press and hold the Volume Down button until the volume is all the way down. Then, press Volume Down again to turn on Alarms Only.

To turn off Alarms Only, press either the Volume Up or Volume Down button and then touch END NOW in the alert message. Then, press Volume Up again to turn on Alarms Only.

### Priority Notifications Only


To only be interrupted by important notifications, choose Priority Only. This option does not mute sounds from music, videos, games, or other media.

Before turning on Priority Only mode, set the notification priorities:

1. Swipe down from the status bar to open the quick access panel and then touch .
2. Touch  **Sound > Do not disturb > Priority only allows**.
3. Set priorities.
  - **Alarms:** Disabled by default.
  - **Reminders and Events:** Switch on or off.
  - **Messages and Calls:** Choose **From anyone**, **From contacts only**, **From starred contacts only**, or **none**. To star contacts, use the **Contacts** app.
  - **Repeat callers:** Choose whether to let the WT6000 ring if the same person calls again within 15 minutes.

After setting notification priorities, turn on Priority only mode to limit interruptions. The priority notifications make a sound or vibrate based on the current ringer volume, but other notifications will be silenced.

1. Swipe down with two fingers from the status bar to open the quick access panel.
2. Touch **Do not disturb > Priority only**.
3. Choose **Until you turn it off** or select a time period.
4. Tap **Done**.

When Priority Only is on,  appears in the quick access panel and the Status Bar.



To turn off Priority Only, open quick access panel and touch **Priority only**.

---

## Automatically Block Sounds and Vibrations

### Silence Sounds During Certain Times



To automatically silence the WT6000 during certain times, like at night or on weekends, set the time rules.

1. Swipe down from the status bar to open the quick access panel and then touch .
2. Touch  **Sound > Do not disturb > Automatic rules**.
3. Touch a default **Weekend** or **Weeknight**. Or, to make a new rule, touch **Add rule** and then **Time rule**.

4. Edit the new rule:
  - **Rule name:** Name the rule.
  - **Days, Start time, and End time:** Set the rule's schedule.
  - **Do not disturb:** Choose whether the rule uses **Alarms only**, **Priority only**, or **Total silence**.
5. Touch the On/Off text or switch at the top to turn on the rule.

### Silence Sounds During Events and Meetings

To automatically silence the WT6000 during events or meetings, set an event rule.

1. Swipe down from the status bar to open the quick access panel and then touch .
2. Touch  **Sound > Do not disturb > Automatic rules**.
3. To edit the default rule, touch **Event**. Or, to create a new rule, touch **Add rule > Event rule**.
4. Edit the rule settings.
  - **During events for:** Select which Google Calendar events the rule uses.
  - **Where reply is:** Options: **Yes, Maybe, or Not replied, Yes or Maybe, or Yes**.
  - **Do not disturb:** Choose whether the rule uses **Priority only, Alarms only, or Total silence**.
5. Touch the On/Off switch at the top to turn on the rule.

### Turn Sounds Back On


When the WT6000 is in Do Not Disturb mode, Alarms or Priority only  or Total silence  display.

To turn off Do Not Disturb, either:

- In the quick access panel, touch **Alarms only, Priority only, or Total silence**.
- Press the Volume Down button and touch **End Now**.

### Override Do Not Disturb for Specific Apps

To let through notifications from specific apps:














1. Open **Settings >  Notifications**.
2. Touch an app.
3. Touch **Override Do Not Disturb**.

---











## Applications

The APPS screen displays icons for all installed applications. The table below lists the applications installed on the WT6000. Refer to the WT6000 Integrator Guide for information on installing and uninstalling application.



**Table 8** Applications

Icon	Description
	<b>App Gallery</b> - Provides links to utilities and demonstration applications that can be installed on the WT6000.
	<b>Battery Manager</b> - Displays battery information, including charge level, status, health and wear level.
	<b>Bluetooth Pairing Utility</b> – Use to pair the RS6000 Hans-free Imager with the WT6000 by scanning a bar code.
	<b>Calculator</b> - Provides the basic and scientific arithmetic functions.
	<b>Calendar</b> - Use to manage events and appointments.
	<b>Chromium</b> - Use to access the Internet or intranet.
	<b>Clock</b> - Use to schedule alarms for appointments or as a wake-up.
	<b>Contacts</b> - Use to manage contact information.
	<b>DataWedge</b> - Enables data capture using the imager.
	<b>Device Central</b> - Displays detailed information about the WT6000 and supported peripherals. See <a href="#">Device Central on page 76</a> for more information.
	<b>Diagnostic Tool</b> - Use to diagnose the WT6000.
	<b>Downloads</b> - Lists all downloads files.
	<b>DWDemo</b> - Provides a way to demonstrate the data capture features using the imager. See <a href="#">DataWedge Demonstration on page 89</a> for more information.

**Table 8** Applications (Continued)

Icon	Description
	<b>Email</b> - Use to send and receive email.
	<b>File Browser</b> - Organize and manage files on the WT6000. See <a href="#">File Browser on page 78</a> for more information.
	<b>Gallery</b> - Use to view photos stored on the device.
	<b>License Manager</b> - Use to manage software licenses on the WT6000.
	<b>Music</b> - Play music stored on the device.
	<b>PTT Express</b> - Use to launch PTT Express client for VoIP communication.
	<b>PTT Express</b> - Use to launch PTT Express client for VoIP communication.
	<b>RxLogger</b> - Use to diagnose device and application issues. See the WT6000 Integrator Guide for more information.
	<b>RxLogger Utility</b> – Use to monitor data from log files on the WT6000 while RxLogger is running. See <a href="#">RxLogger Utility on page 91</a> for more information.
	<b>Search</b> - Use the Google search engine to search the Internet and the WT6000.
	<b>Settings</b> - Use to configure the WT6000.
	<b>Sound Recorder</b> - Use to record audio.

**Table 8** Applications (Continued)

Icon	Description
	<b>StageNow</b> - Allows the WT6000 to stage a device for initial use by initiating the deployment of settings, firmware and software.
	<b>Velocity</b> - Opens the Ivanti (formerly Wavelink) terminal emulation application.

## Accessing Applications

All applications installed on the device are accessed using the **APPS** window.


1. On the Home screen, swipe up from the bottom of the screen.

**Figure 32** APPS Window

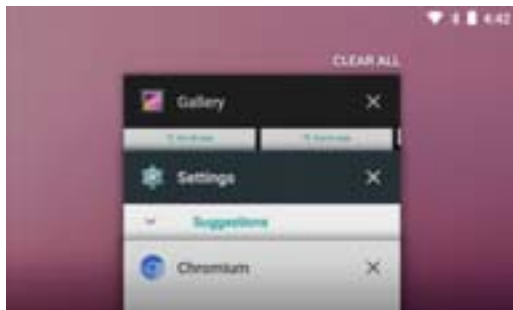



2. Slide the **APPS** window up or down to view more application icons. Touch an icon to open the application. See [Application Shortcuts and Widgets on page 34](#) for information on creating a shortcut on the Home screen.

## Switching Between Recent Applications

1. Touch and hold . A window appears on the screen with icons of recently used applications.

**Figure 33** Recently Used Applications



2. Slide the window up and down to view all recently used applications.
3. Swipe left or right to remove application from the list and force close the application.
4. Touch an icon to open it or touch  to return to the current screen.



## Un-Locking the Screen

Use the Lock screen to protect access to data on the WT6000. Some email account require locking the screen. Refer to the WT6000 Integrator Guide for information on setting up the locking feature. The Locking feature functions differently in Single User mode or Multiple User mode.

When locked, a pattern, PIN or password is required to unlock the device. Press the Power button to lock the screen. The device also locks after a pre-defined time-out.

Press and release the Power button to wake the device. The Lock screen displays. Swipe the screen up to unlock. If the Pattern screen unlock feature is enabled, the Pattern screen appears instead of the Lock screen. If the PIN or Password screen unlock feature is enabled, enter the PIN or password after unlocking the screen.

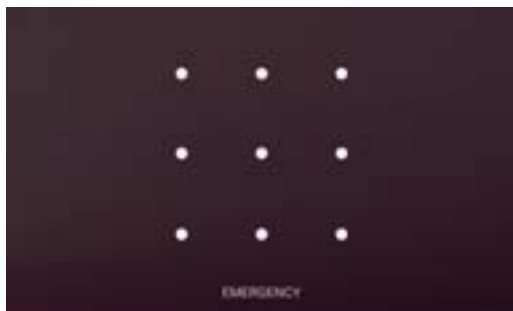
**Figure 34** Lock Screen



**Figure 35** PIN Screen



**Figure 36** Pattern Screen



**Figure 37** Password Screen



---

## Suspend Mode

The WT6000 goes into suspend mode when the user presses the Power button or after a period of inactivity (set in the Display settings).

To wake the WT6000 from Suspend mode, press the Power button. The Lock screen displays. Swipe the screen up to unlock. If the Pattern screen unlock feature is enabled, the Pattern screen appears instead of the Lock screen. If the PIN or Password screen unlock feature is enabled, enter the PIN or password after unlocking the screen. See [Un-Locking the Screen on page 49](#).



**NOTE:** If the user enters the PIN, password or pattern incorrectly five times, they must wait 30 seconds before trying again.

If the user forgets the PIN, password or pattern contact the system administrator.

---

## Resetting the WT6000

There are two reset functions:

- Soft reset
- Hard reset.

### Performing a Soft Reset

Perform a soft reset if applications stop responding.

1. Press the power button until the menu appears.
2. Touch **Reset**.
3. The device reboots.

### Performing a Hard Reset



**CAUTION:** Performing a hard reset with a microSD card installed in the WT6000 may cause damage or data corruption to the microSD card.

Perform a hard reset if the WT6000 stops responding.

1. Simultaneously press and hold the power, P1 and P2 buttons for five seconds.
2. When the screen turns off, release the buttons.
3. The WT6000 reboots.

## Transferring Files with a Host Computer via USB

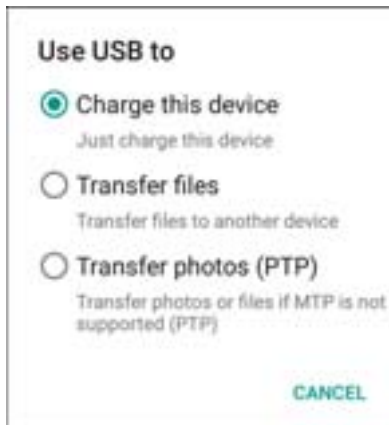
Connect the WT6000 to a host computer using the USB/Charge Cable, 1-Slot Charging Cradle, or 2-Slot Charging Cradle to transfer files between the WT6000 and the host computer. See [Accessories](#) for more information.

When connecting the WT6000 to a host computer, follow the host computer's instructions for connecting and disconnecting USB devices, to avoid damaging or corrupting files.

### Transferring Files using Media Transfer Protocol

1. Connect the Rugged Charge/USB Cable to the WT6000 or place the WT6000 into the 1-Slot Charging Cradle, or 2-Slot Charging Cradle. See [Accessories](#) for setup information.
2. Pull down the Notification panel and touch **USB charging this device**.

**Figure 38** Use USB Dialog Box



3. Touch **Transfer files**.
4. On the host computer, open a file explorer application.
5. Locate the **WT6000** as a portable device.
6. Open the **Internal storage** folder.
7. Copy files to and from the WT6000 or delete files as required.

### Transferring Files using Photo Transfer Protocol



**NOTE:** Use Photo Transfer Protocol (PTP) to copy photos from either the microSD card or internal memory to the host computer.

1. Connect the Rugged Charge/USB Cable to the WT6000 or place the WT6000 into the 1-Slot Charging Cradle, or 2-Slot Charging Cradle. See [Accessories](#) for setup information.
2. Pull down the Notification panel and touch **USB charging this device**.
3. Touch **Transfer photos (PTP)**.
4. On the host computer, open a file explorer application.
5. Open the **Internal storage** folder.
6. Copy or delete photos as required.

## Disconnect from the Host Computer



**CAUTION:** Carefully follow the host computer's instructions to unmount the microSD card and disconnect USB devices correctly to avoid losing information.

1. On the host computer, unmount the device.
2. Remove the USB Charging cable from the device or remove the device from the cradle.

# Data Capture

---

## Introduction

The WT6000 can be used with the following optional data capture accessories:

- RS4000 laser scanner
- RS5,000 corded imager
- RS6000 Hands-free imager
- RS507/RS507X Hands-free imager.

---

## Laser Scanning

WT6000 with an optional RS4000 laser scanner has the following features:

- Reading of a variety of bar code symbologies, including the most popular linear and 1D code types.
- Advanced intuitive laser aiming for easy point-and-shoot operation
- Adaptive scanning.

## Scanning Bar Codes



**NOTE:** Scanning procedures depend on the application and WT6000 configuration. An application may use different scanning procedures from the one listed below.

---

## Imaging

The WT6000 with an optional RS507, RS5,000 or RS6000 imager has the following features:

- Omnidirectional (360°) reading of a variety of bar code symbologies, including the most popular linear, postal, PDF417, and 2D matrix code types.
- Advanced intuitive laser aiming for easy point-and-shoot operation.

The imager uses imaging technology to take a picture of a bar code, stores the resulting image in its memory, and executes state-of-the-art software decoding algorithms to extract the bar code data from the image.

## Operational Modes

The optional imager supports two modes of operation. Activate each mode pressing the **Scan** button.

- **Decode Mode:** In this mode, the imager attempts to locate and decode bar codes within its field of view. The imager remains in this mode as long as the user holds the scan button, or until it decodes a bar code.



**NOTE:** To enable Pick List Mode use **DataWedge**. Pick List can also be set in an application using a API command.

- **Pick List Mode:** This mode allows the user to selectively decode a bar code when more than one bar code is in the imager's field of view. To accomplish this, move the aiming crosshair center dot over the required bar code to decode only that bar code. This feature is ideal for pick lists containing multiple bar codes and manufacturing or transport labels containing more than one bar code (either 1D or 2D).

---

## Scanning Considerations

Typically, scanning is a simple matter of aim, scan/decode and a few quick trial efforts master it. However, two important considerations can be used to optimize any scanning performance:

- Range

Any scanning device decodes well over a particular working range - minimum and maximum distances from the bar code. This range varies according to bar code density and scanning device optics.

Scanning within range brings quick and constant decodes; scanning too close or too far away prevents decodes. Move the scanner closer and further away to find the right working range for the bar codes being scanned. However, the situation is complicated by the availability of various integrated scanning modules. The best way to specify the appropriate working range per bar code density is through a chart called a decode zone for each scan module. A decode zone simply plots working range as a function of minimum element widths of bar code symbols. Refer to the WT6000 Integrator Guide for decode zones for the optional data capture options.

- Angle

Scanning angle is important for promoting quick decodes. When laser beams reflect directly back into the scanner from the bar code, this specular reflection can "blind" the scanner.

To avoid this, scan the bar code so that the beam does not bounce directly back. But don't scan at too sharp an angle; the scanner needs to collect scattered reflections from the scan to make a successful decode. Practice quickly shows what tolerances to work within.



**NOTE:** Contact the Zebra Global Support Center if chronic scanning difficulties develop. Decoding of properly printed bar codes should be quick and effortless.

---

## Bar Code Capture with RS4000

To read a bar code, a scan-enabled application is required. The WT6000 contains the **DataWedge** application that allows the user to enable the scanner to decode bar code data and display the bar code content. See [DataWedge on page 89](#) for information on enabling **DataWedge**.

1. Connect the RS4000 to the WT6000. See [RS4000 Scanner on page 131](#) for more information.
2. Ensure that a scan enabled application is loaded or DataWedge is enabled (see [DataWedge on page 89](#) for more information).
3. Press the trigger.

4. Aim the scan beam at the bar code.

Ensure the red scan beam covers the entire bar code. The Decode LED lights red to indicate that scanning is in process, then lights green and a beep sounds, by default, to indicate the bar code was decoded successfully.

**Figure 39** Laser Scanner Aiming Pattern



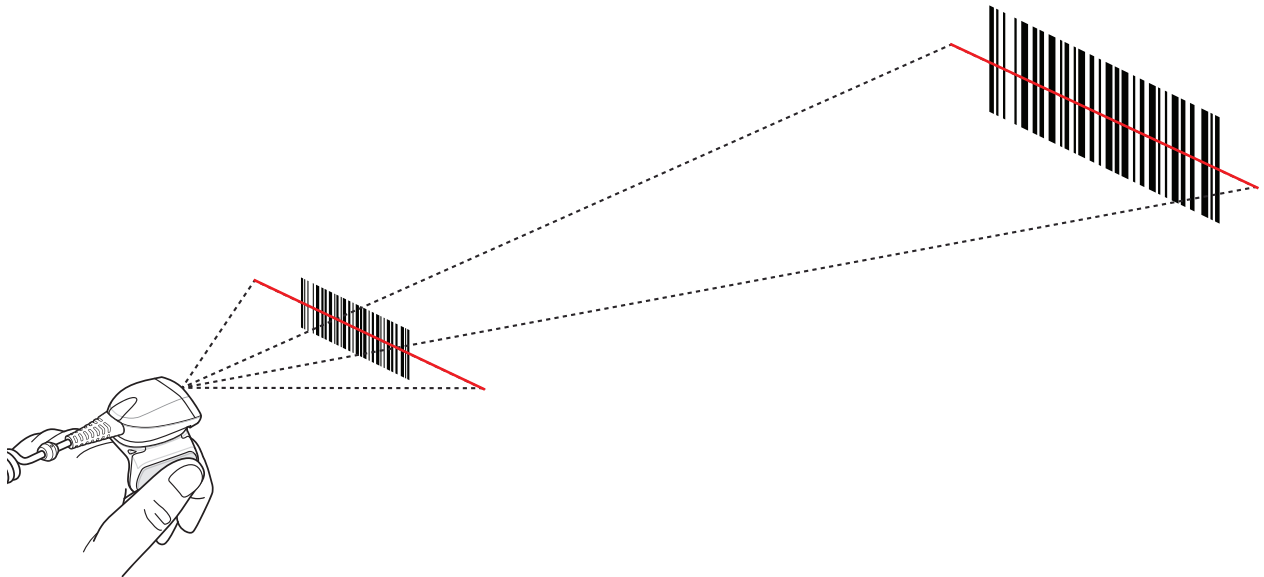
5. Release the trigger.

## Adaptive Scanning

The RS4000 contains the adaptive scanning feature that automatically adjusts the scan beam width for rapid and easy scanning of bar codes from near contact to more than 200 inches away.

By default the RS4000 is set to wide scan beam width. When the user presses the trigger, the RS4000 determines the distance from the bar code. For close bar codes the RS4000 sets a wide beam width and for far bar codes it sets a narrow beam width. The RS4000 uses distance, bar code type and material to determine the correct scan beam width.

**Figure 40** RS4000 Adaptive Scanning



---

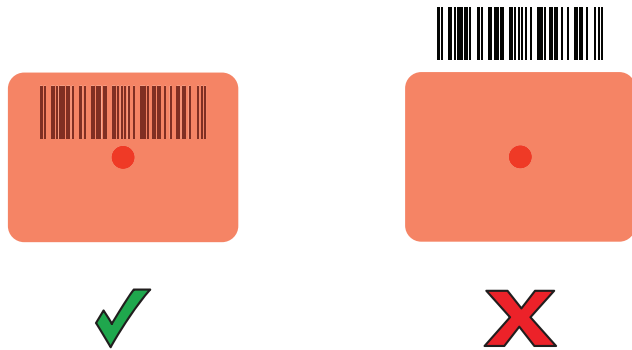
## Bar Code Capture with RS5,000 Corded Imager

To read a bar code, a scan-enabled application is required. The WT6000 contains the **DataWedge** application that allows the user to enable the scanner to decode bar code data and display the bar code content. See [DataWedge on page 89](#) for more information on launching DataWedge.



1. Connect the RS5,000 to the WT6000. See [RS5000 Imager on page 133](#) for more information.
2. Press the scan trigger and aim the RS5,000 at a bar code.
3. Ensure the bar code is within the area formed by the aiming pattern. The aiming dot is used for increased visibility in bright lighting conditions.

**Figure 41** RS5,000 Aiming Pattern



**Figure 42** RS5,000 Pick List Mode with Multiple Bar Codes



4. If the decode is successful the LED lights green. The terminal beeps if programmed accordingly.



**NOTE:** Imager decoding usually occurs instantaneously. The RS5,000 repeats the steps required to take a digital picture (image) of a poor or difficult bar code as long as the scan button remains pressed.

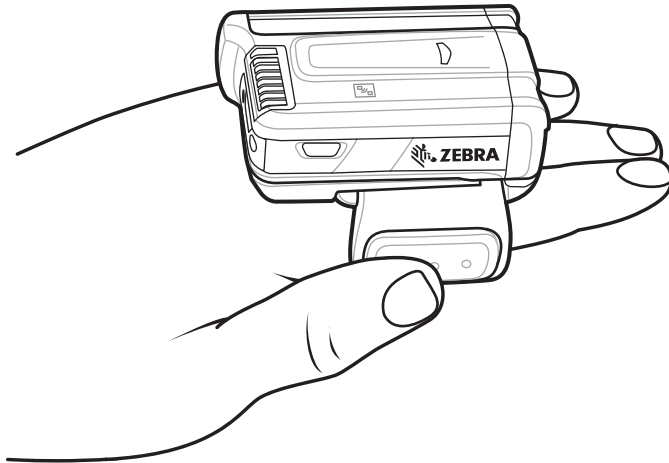
## Bar Code Capture with RS6000 Hands-Free Imager

To read a bar code, a scan-enabled application is required. The WT6000 contains the **DataWedge** application that allows the user to enable the scanner to decode bar code data and display the bar code content. See [DataWedge on page 89](#) for more information on launching DataWedge.

Pair the RS6000 with the WT6000. See [Pairing Using Simple Serial Interface on page 62](#) or [Pairing Using Bluetooth Human Interface Device on page 63](#) for more information.

1. Ensure that an application is open on the device and a text field is in focus (text cursor in text field).
2. Point the RS6000 at a bar code.

**Figure 43** Bar Code Scanning with RS6000

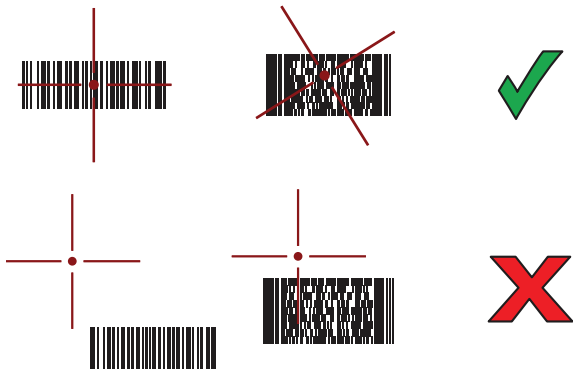


3. Press and hold the trigger.

The red laser aiming pattern turns on to assist in aiming. Ensure the bar code is within the area formed by the cross-hairs in the aiming pattern. The aiming dot is used for increased visibility in bright lighting conditions.

The RS6000 LEDs light green, a beep sounds to indicate the bar code was decoded successfully. Note that when the RS6000 is in Pick List Mode, the RS6000 does not decode the bar code until the center of the crosshair touches the bar code.

**Figure 44** Aiming Pattern



**Figure 45** Pick List Mode with Multiple Bar Codes in Aiming Pattern



4. The captured data appears in the text field.

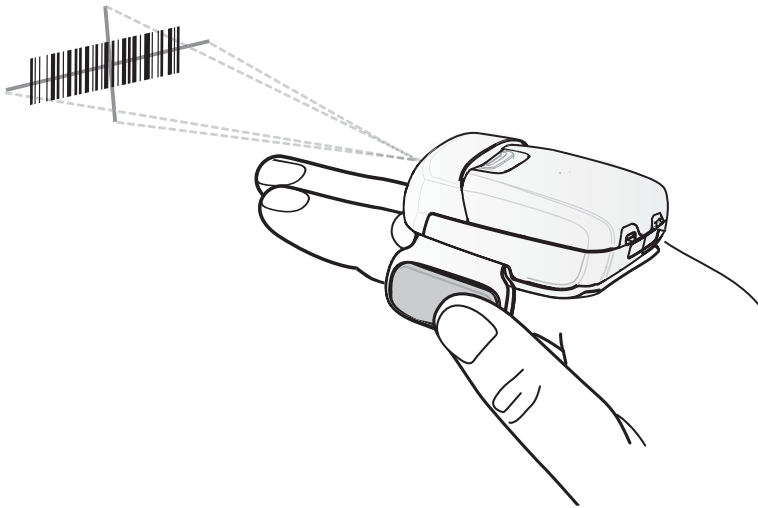
## Bar Code Capture with RS507 Hands-Free Imager

To read a bar code, a scan-enabled application is required. The WT6000 contains the **DataWedge** application that allows the user to enable the scanner to decode bar code data and display the bar code content. See [DataWedge on page 89](#) for more information on launching DataWedge.

Pair the RS507 with the WT6000. See [Pairing Using Simple Serial Interface on page 62](#) or [Pairing Using Bluetooth Human Interface Device on page 63](#) for more information.

1. Ensure that an application is open on the device and a text field is in focus (text cursor in text field).
2. Point the RS507 at a bar code.

**Figure 46** Bar Code Scanning with RS507

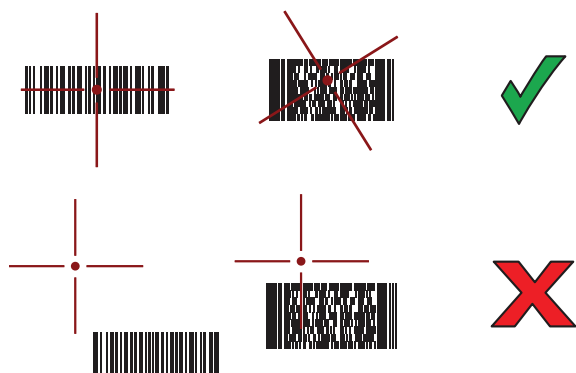


3. Press and hold the trigger.

The red laser aiming pattern turns on to assist in aiming. Ensure the bar code is within the area formed by the cross-hairs in the aiming pattern. The aiming dot is used for increased visibility in bright lighting conditions.

The RS507 LEDs light green, a beep sounds to indicate the bar code was decoded successfully. Note that when the RS507 is in Pick List Mode, the RS507 does not decode the bar code until the center of the crosshair touches the bar code.

**Figure 47** Aiming Pattern



**Figure 48** Pick List Mode with Multiple Bar Codes in Aiming Pattern

4. The captured data appears in the text field.

## Pairing the RS507/RS6000 Hands-Free Imager

To connect the RS507 or RS6000 imagers to the WT6000, use one of the following methods:

- Near Field Communication (NFC)
- Simple Serial Interface (SSI)
- Bluetooth Human Interface Device (HID) Mode.


### Pairing Using Near Field Communication

The WT6000 provides the ability to pair the RS6000 using NFC.

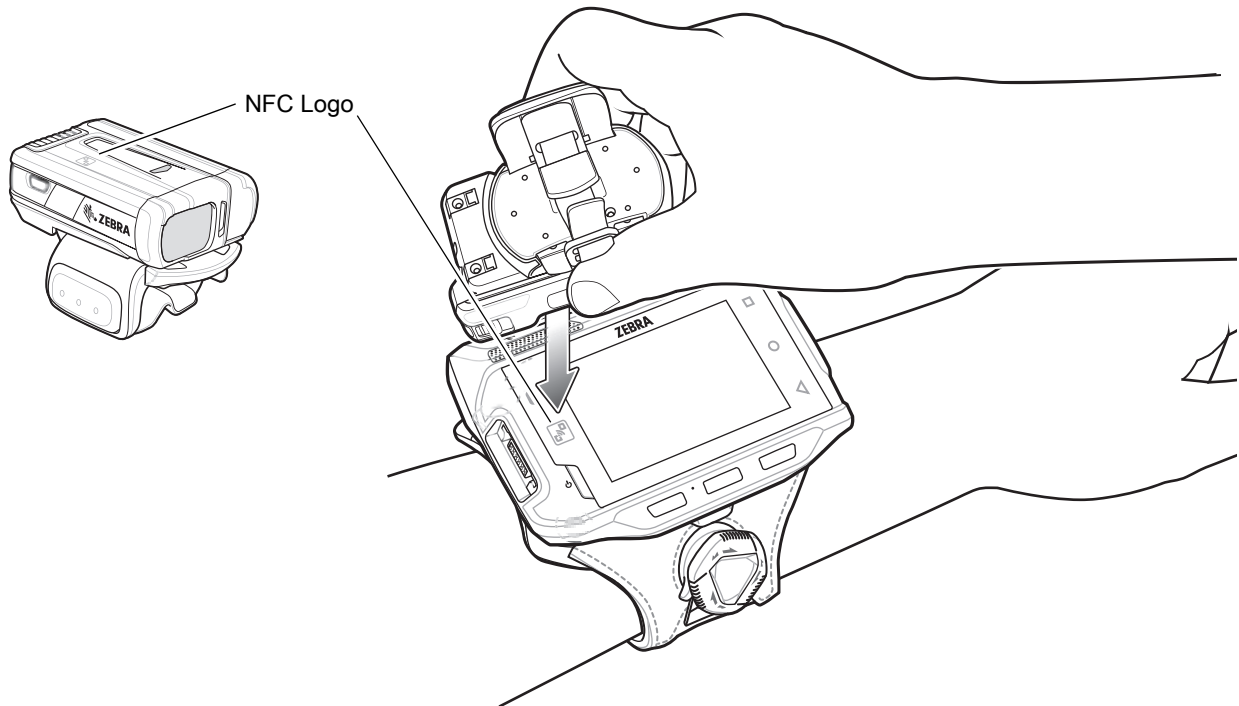
✓ **NOTE:** RS6000 only.


1. Ensure that the RS6000 is in SSI mode. Refer to the RS6000 User Guide for more information.
2. Ensure that NFC is enabled on the WT6000.
3. Align the NFC icon on the RS6000 with the NFC icon on the WT6000.

The Status LED blinks blue indicating that the RS6000 is attempting to establish connection with the WT6000. When connection is established, the Status LED turns off and the RS6000 emits a single string of low/high beeps.

A notification appears on the WT6000 screen and the  icon appears in the Status bar.

**Figure 49** Align NFC Antennas



The WT6000 pairs with the RS6000 and  appears in the Status bar.

✓ **NOTE:** Not all Zebra device support NFC readers and the Tap-to-Pair feature.

## Pairing in HID Mode Using Near Field Communication

The WT6000 provides the ability to pair the RS6000 in HID Mode using NFC.

✓ **NOTE:** RS6000 Only.

1. Ensure that NFC is enabled on the WT6000.
2. Ensure that Bluetooth is enabled on both devices.
3. Ensure that the Bluetooth device to discover is in discoverable mode.
4. Ensure that the two devices are within 10 meters (32.8 feet) of one another.
5. Place the RS6000 in Human Interface Device (HID) mode. If the RS6000 is already in HID mode, skip to step 5.
  - a. Remove the battery from the RS6000.
  - b. Press and hold the Restore key.
  - c. Install the battery onto the RS6000.
  - d. Keep holding the Restore key for about five seconds until a chirp is heard and the Scan LEDs flash green.
  - e. Scan the bar code below to place the RS6000 in HID mode.

**Figure 50** Bluetooth HID Bar Code



6. Remove the battery from the RS6000.
7. Re-install the battery into the RS6000.



**IMPORTANT:** Use only the standard 3,350 mAh battery in the RS6000.

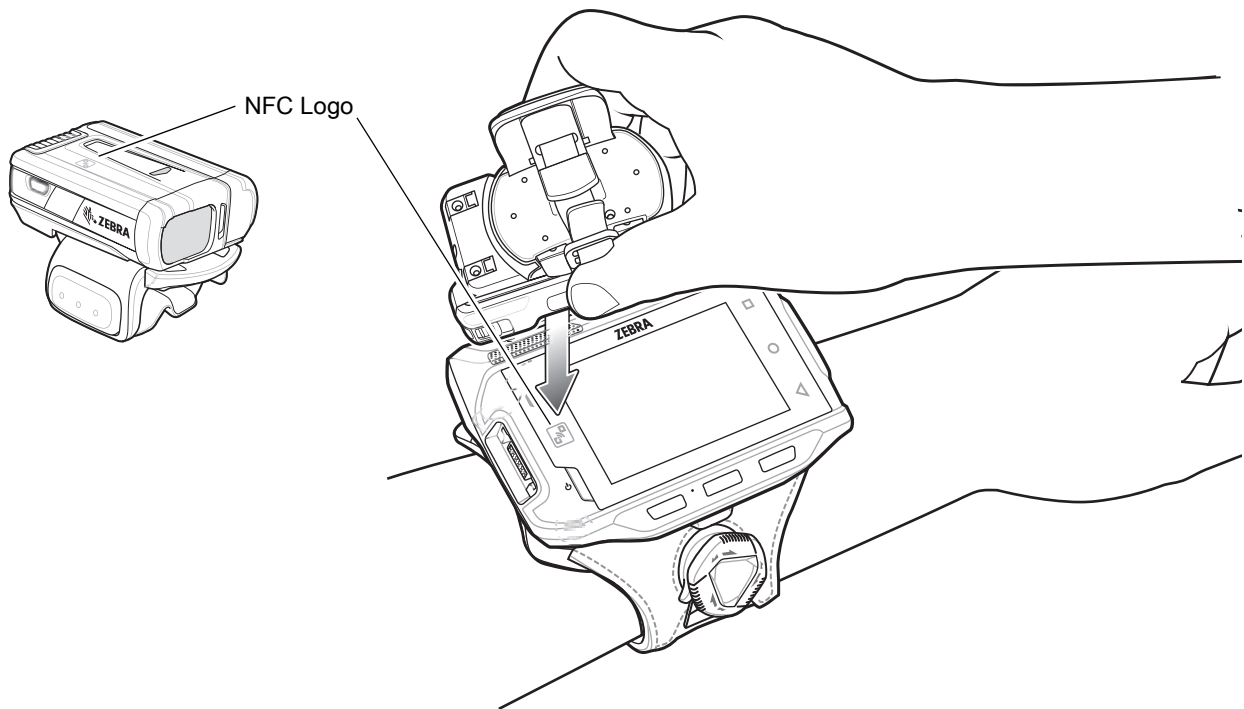
8. Align the NFC icon on the RS6000 with the NFC icon on the WT6000.

The Status LED blinks blue indicating that the RS6000 is attempting to establish connection with the WT6000. When connection is established, the Status LED turns off and the RS6000 emits a single string of low/high beeps.

A notification appears on the WT6000 screen.

The **A** icon appears in the Status bar.

**Figure 51** Align NFC Antennas




The WT6000 pairs with the RS6000 and **A** appears in the Status bar.



**NOTE:** Not all Zebra device support NFC readers and the Tap-to-Pair feature.



## Pairing Using Simple Serial Interface

To pair the RS507/RS6000 with the WT6000 using SSI:

1. Ensure that the two devices are within 10 meters (32.8 feet) of one another.
2. Install the battery into the RS6000.
3. On the WT6000 swipe up from the bottom of the Home screen and touch .

**Figure 52** Bluetooth Pairing Utility



4. Using the RS507/RS6000, scan the bar code on the screen.  
The RS507/RS6000 emits a high/low/high/low beeps. The Scan LED flashes green indicating that the RS507/RS6000 is attempting to establish connection with the WT6000. When connection is established, the Scan LED turns off and the RS6000 emits one string of low/high beeps.  
A notification appears on the WT6000 screen and the  icon appears in the Status bar.
5. On the WT6000, touch .



## Pairing Using Bluetooth Human Interface Device

To pair the RS507/RS6000 with the WT6000 using HID:

1. Ensure that Bluetooth is enabled on both devices.
2. Ensure that the Bluetooth device to discover is in discoverable mode.
3. Ensure that the two devices are within 10 meters (32.8 feet) of one another.
4. Place the RS507/RS6000 in Human Interface Device (HID) mode. If the RS507/RS6000 is already in HID mode, skip to step 5.
  - a. Remove the battery from the RS507/RS6000.
  - b. Press and hold the Restore key.
  - c. Install the battery onto the RS507/RS6000.
  - d. Keep holding the Restore key for about five seconds until a chirp is heard and the Scan LEDs flash green.
  - e. Scan the bar code below to place the RS507/RS6000 in HID mode.

**Figure 53** Bluetooth HID Bar Code



5. Remove the battery from the RS507/RS6000.
6. Re-install the battery into the RS507/RS6000.
7. Swipe down from the status bar to open the quick access panel and then touch .
8. Touch  **Bluetooth**.
9. Touch **SCAN FOR DEVICES**. The device begins searching for discoverable Bluetooth devices in the area and displays them under **AVAILABLE DEVICES**.
10. Scroll through the list and select RS507/RS6000.

The device connects to the RS507/RS6000 and **Connected** appears below the device name. The Bluetooth device is added to the **Bluetooth devices** list and a trusted ("paired") connection is established.



# Wireless

---

## Wireless Local Area Networks

Wireless local area networks (WLANs) allow the WT6000 to communicate wirelessly inside a building. Before using the WT6000 on a WLAN, the facility must be set up with the required hardware to run the WLAN (sometimes known as infrastructure). The infrastructure and the WT6000 must both be properly configured to enable this communication.

Refer to the documentation provided with the infrastructure (access points (APs), access ports, switches, Radius servers, etc.) for instructions on how to set up the infrastructure.

Once the infrastructure is set up to enforce the chosen WLAN security scheme, use the **Wireless & networks** settings to configure the WT6000 to match the security scheme.

The WT6000 supports the following WLAN security options:

- Open
- Wireless Equivalent Privacy (WEP).
- Wi-Fi Protected Access (WPA/WPA2) Personal (PSK).
- Extensible Authentication Protocol (EAP).
  - Protected Extensible Authentication Protocol (PEAP) - with MSCHAPV2 and GTC authentication.
  - Transport Layer Security (TLS)
  - TTLS - with Password Authentication Protocol (PAP), MSCHAP and MSCHAPv2 authentication.
  - LEAP
  - FAST - with MSCHAPV2 and GTC authentication.

The **Status** bar displays icons that indicate Wi-Fi network availability and Wi-Fi status. See [Status Bar on page 30](#) for more information.



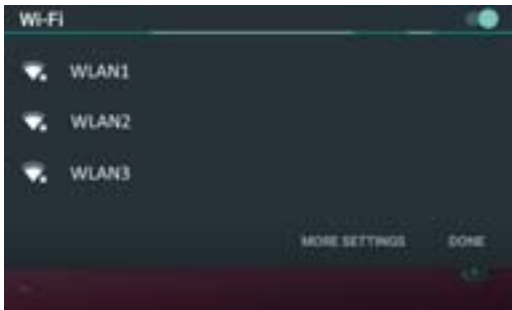
**NOTE:** Turn off Wi-Fi when not using it, to extend the life of the battery.

## Scan and Connect to a Wi-Fi Network

1. Swipe down with two fingers from the status bar to open the quick access panel.

**Figure 54** Quick Access Panel

2. Touch **WLAN** to open the **WLAN** screen. The device searches for WLANs in the area and lists them.




**Figure 55** WLAN Screen

3. Scroll through the list and select the desired WLAN network.
4. For open networks, touch profile once or press and hold and then select **Connect to network** or for secure networks enter the required password or other credentials then touch **Connect**. See the system administrator for more information.

The WT6000 obtains a network address and other required information from the network using the dynamic host configuration protocol (DHCP) protocol. To configure the WT6000 with a fixed internet protocol (IP) address, refer to the WT6000 Wearable Computer Integrator Guide for Android 7.1.2.

5. In the Wi-Fi setting field, **Connected** appears indicating that the WT6000 is connected to the WLAN.

## Remove a Wi-Fi Network

1. Swipe down from the status bar to open the quick settings bar and then touch .
2. Touch  **Wi-Fi**.
3. In the **Wi-Fi** list, touch and hold the name of the network.
4. In the menu, touch **Forget network**.
5. Touch .

## Bluetooth

Bluetooth-equipped devices can communicate without wires, using frequency-hopping spread spectrum (FHSS) radio frequency (RF) to transmit and receive data in the 2.4 GHz Industry Scientific and Medical (ISM) band (802.15.1). Bluetooth wireless technology is specifically designed for short-range (10 meters (32.8 feet)) communication and low power consumption.

Devices with Bluetooth capabilities can exchange information (e.g., files, appointments, and tasks) with other Bluetooth enabled devices such as printers, access points, and other mobile devices.

## Adaptive Frequency Hopping

Adaptive Frequency Hopping (AFH) is a method of avoiding fixed frequency interferers, and can be used with Bluetooth voice. All devices in the piconet (Bluetooth network) must be AFH-capable in order for AFH to work. There is no AFH when connecting and discovering devices. Avoid making Bluetooth connections and discoveries during critical 802.11b communications. AFH for Bluetooth consists of four main sections:

- **Channel Classification** - A method of detecting an interference on a channel-by-channel basis, or pre-defined channel mask.
- **Link Management** - Coordinates and distributes the AFH information to the rest of the Bluetooth network.
- **Hop Sequence Modification** - Avoids interference by selectively reducing the number of hopping channels.
- **Channel Maintenance** - A method for periodically re-evaluating the channels.

When AFH is enabled, the Bluetooth radio “hops around” (instead of through) the 802.11b high-rate channels. AFH coexistence allows Enterprise devices to operate in any infrastructure.

The Bluetooth radio in this device operates as a Class 2 device power class. The maximum output power is 2.5 mW and the expected range is 10 meters (32.8 ft.). A definition of ranges based on power class is difficult to obtain due to power and device differences, and whether one measures open space or closed office space.



**NOTE:** It is not recommended to perform Bluetooth wireless technology inquiry when high rate 802.11b operation is required.

## Security

The current Bluetooth specification defines security at the link level. Application-level security is not specified. This allows application developers to define security mechanisms tailored to their specific need. Link-level security occurs between devices, not users, while application-level security can be implemented on a per-user basis. The Bluetooth specification defines security algorithms and procedures required to authenticate devices, and if needed, encrypt the data flowing on the link between the devices. Device authentication is a mandatory feature of Bluetooth while link encryption is optional.

Pairing of Bluetooth devices is accomplished by creating an initialization key used to authenticate the devices and create a link key for them. Entering a common personal identification number (PIN) in the devices being paired generates the initialization key. The PIN is never sent over the air. By default, the Bluetooth stack responds with no key when a key is requested (it is up to user to respond to the key request event). Authentication of Bluetooth devices is based-upon a challenge-response transaction. Bluetooth allows for a PIN or passkey used to create other 128-bit keys used for security and encryption. The encryption key is derived from the link key used to authenticate the pairing devices. Also worthy of note is the limited range and fast frequency hopping of the Bluetooth radios that makes long-distance eavesdropping difficult.

Recommendations are:

- Perform pairing in a secure environment
- Keep PIN codes private and do not store the PIN codes in the device
- Implement application-level security.

## Bluetooth Profiles

The device supports the following Bluetooth services:

- **Service Discovery Protocol (SDP)** - Handles the search for known and specific services as well as general services.
- **Serial Port Profile (SPP)** - Allows use of RFCOMM protocol to emulate serial cable connection between two Bluetooth peer devices. For example, connecting the device to a printer.
- **Advanced Audio Distribution Profile (A2DP)** - Allows the device to stream stereo-quality audio to a wireless headset or wireless stereo speakers.
- **Audio/Video Remote Control Profile (AVRCP)** - Allows the device to control A/V equipment to which a user has access. It may be used in concert with A2DP.
- **Human Interface Device Profile (HID)** - Allows Bluetooth keyboards, pointing devices, gaming devices and remote monitoring devices to connect to the device.
- **Object Push Profile (OPP)** - Allows the device to push and pull objects to and from a push server.
- **Headset Profile (HSP)** - Allows a hands-free device, such as a Bluetooth headset, to place and receive calls on the device.
- **Hands-Free Profile (HFP)** - Allows car hands-free kits to communicate with the device in the car.
- **Personal Area Network (PAN)** - Allows the use of Bluetooth Network Encapsulation Protocol to provide L3 networking capabilities over a Bluetooth link. Only PANU role is supported.
- **Out of Band (OOB)** - Allows exchange of information used in the pairing process. Pairing is completed using the Bluetooth radio, but requires information from the OOB mechanism. Using OOB with NFC enables pairing when devices simply get close, rather than requiring a lengthy discovery process.
- **Symbol Serial Interface (SSI)** - Allows for communication with RS507 Bluetooth Imager.

## Bluetooth Power States

The Bluetooth radio is off by default.

- **Suspend** - When the WT6000 goes into suspend mode, the Bluetooth radio stays on.
- **Airplane Mode** - When the WT6000 is placed in Airplane Mode, the Bluetooth radio turns off. When Airplane mode is disabled, the Bluetooth radio returns to the prior state. When in Airplane Mode, the Bluetooth radio can be turned back on if desired.



## Bluetooth Radio Power

Turn off the Bluetooth radio to save power or if entering an area with radio restrictions (e.g., an airplane). When the radio is off, other Bluetooth devices cannot see or connect to the device. Turn on the Bluetooth radio to exchange information with other Bluetooth devices (within range). Communicate only with Bluetooth radios in close proximity.





**NOTE:** To achieve the best battery life turn off radios when not in use.

## Enabling Bluetooth

1. Swipe down with two fingers from the status bar to open the quick access panel.
2. Touch  to turn Bluetooth on.
3. Touch .

## Disabling Bluetooth

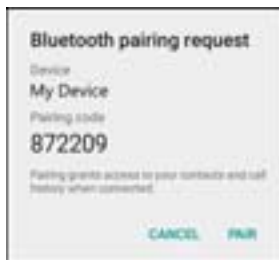
1. Swipe down with two fingers from the status bar to open the quick access panel.
2. Touch  to turn Bluetooth off.
3. Touch .

## Discovering Bluetooth Device(s)

The WT6000 can receive information from discovered devices without pairing. However, once paired, the WT6000 and a paired device exchange information automatically when the Bluetooth radio is on. To find Bluetooth devices in the area:

1. Ensure that Bluetooth is enabled on both devices.
2. Ensure that the Bluetooth device to discover is in discoverable mode.
3. Ensure that the two devices are within 10 meters (32.8 feet) of one another.
4. Swipe down with two fingers from the status bar to open the quick access panel.
5. Touch **Bluetooth**.
6. Touch **More Settings**. The **Bluetooth** screen appears.
7. The WT6000 begins searching for discoverable Bluetooth devices in the area and displays them under **Available devices**.
8. Scroll through the list and select a device. The **Bluetooth pairing request** dialog box appears.



**Figure 56** Bluetooth Pairing - Smart Pairing





9. Enter a PIN in the text box and touch **OK**. Enter the same PIN on the other device.
10. For Simple Pairing, touch **Pair** on both devices.
11. The Bluetooth device is added to the **Paired devices** list and a trusted (“paired”) connection is established.

## Changing the Bluetooth Name



By default, the WT6000 has a generic Bluetooth name that is visible to other devices when connected.

1. Swipe down from the status bar to open the quick settings bar and then touch .
2. Touch  **Bluetooth**.
3. If Bluetooth is not on, touch the switch to turn Bluetooth on.

4. Touch .
5. Touch **Rename this device**.
6. Enter a name and touch **Rename**.
7. Touch .





## Connecting to a Bluetooth Device

Once paired, connect to a Bluetooth device.

1. Swipe down from the status bar to open the quick settings bar and then touch .
2. Touch  **Bluetooth**.
3. If Bluetooth is not on, touch the switch to turn Bluetooth on.
4. In the list, touch the unconnected Bluetooth device.
5. When connected, Connected appears below the device name.





## Selecting Profiles on the Bluetooth Device

Some Bluetooth devices have multiple profiles. To select a profile:

1. Swipe down from the status bar to open the quick settings bar and then touch .
2. Touch  **Bluetooth**.
3. In the **Paired devices** list, touch  next to the device name.
4. Under **Use for**, check or uncheck a profile to allow the device to use that profile.
5. Touch **OK**.
6. Touch .

## Unpairing a Bluetooth Device

To unpair a Bluetooth device and erase all pairing information:

1. Swipe down from the status bar to open the quick settings bar and then touch .
2. Touch  **Bluetooth**.
3. In the **Paired devices** list, touch  next to the device name.
4. Touch **FORGET**.
5. Touch .

---

## Near Field Communications

NFC/HF RFID is a short-range wireless connectivity technology standard that enables secure transaction between a reader and a contactless smart card. The technology is based on ISO/IEC 14443 type A and B (proximity), Felica and ISO/IEC 15693 (vicinity) standards, using the HF 13.56 MHz unlicensed band. The WT6000 supports three operating modes:

- Reader mode




- Peer-to-Peer communication
- Card Emulation mode.

Using NFC, the WT6000 can:

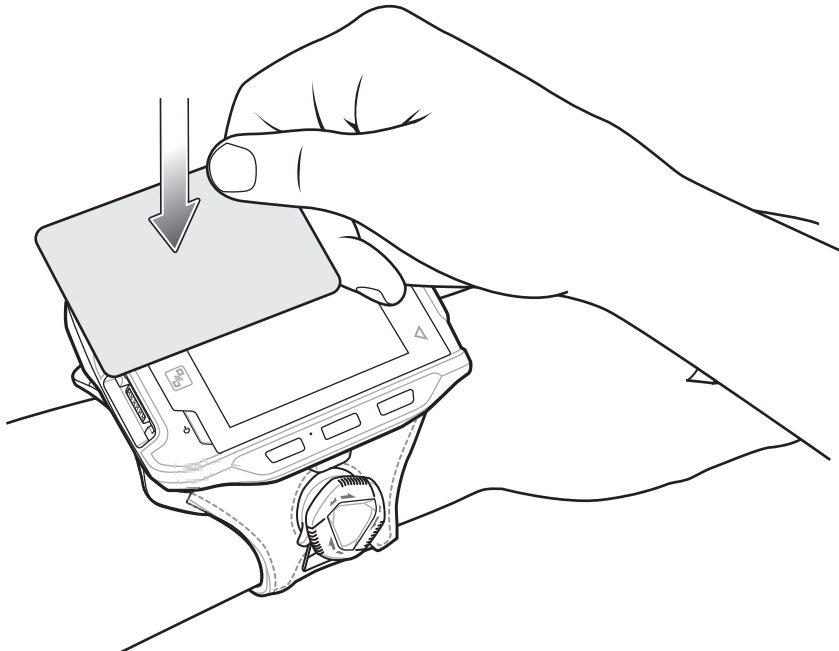
- Read contactless cards such as contactless tickets, NFC labels, HF tokens or standard smart cards.
- Read and write information to contactless cards such as SmartPosters and tickets, as well as devices with NFC interface such as vending machines.
- Read information from supported medical sensors.
- Pair with supported Bluetooth devices such as printers and headsets. See [Pairing Using Near Field Communication on page 60](#) for instruction on pairing the RS6000 Ring Scanner with the WT6000 using NFC.
- Exchange data with another NFC device.
- Emulate contactless card such as ticket or V-card.

The WT6000 NFC antenna is uniquely positioned to read NFC cards from the front of the device.

## Reading NFC Cards

1. Make sure NFC is turned on.
  - a. Swipe down from the status bar to open the quick settings bar and then touch .
  - b. Touch  **More**.
  - c. Ensure that the NFC switch is in the on (green) position.
  - d. Touch .
2. Launch an NFC enabled application or use a NFC NDEF formatted tag.
3. Hold device as shown.

**Figure 57** Reading NFC Card



4. Move NFC card until the WT6000 detects the card.

5. Hold the card steadily until the transaction is complete (usually indicated by the application).



# Applications

---

## Introduction

This chapter describes the applications installed on the device.

---




## Battery Manager

The Battery Manager provides detailed information about the battery.


**Figure 58** Battery Manager Screen



**Table 9** Battery Icon Description

Battery Icon	Description
	Indicates battery charge level.
	Indicates battery charging.
	Indicates battery charge level is below 20%.

- **Battery level** - Indicate the current battery charge level as a percentage. Displays -% when level is unknown.

- **Time until empty** - Indicates the amount of time before the battery is depleted based on current usage. Displays when the device is not on AC power.
- **Time until full** - Indicates the amount of time until the battery is fully charged based on charge rate. Displays when the device is on AC power.
- **Time since charging** - Indicates the amount of time since the battery started charging.
- **Battery status**
  - **Not charging** - Indicates that the device is not connected to AC power.
  - **Charging over AC** - Indicates that the device is connected to AC power and charging.
  - **Charging over USB** - Indicates that the device is connected to a host computer with a USB cable and charging.
  - **Discharging** - Indicates that the battery is discharging.
  - **Full** - Indicates that the battery is fully charged.
  - **Unknown** - Indicates that the battery status is unknown.
- **Battery health** - Indicates the health of the battery. If a critical error occurs,  appears. Touch to view error description.
  - **Decommission** - The battery is past its useful life and should be replaced. See system administrator.
  - **Good** - The battery is good.
  - **Charge error** - An error occurred while charging. See system administrator.
  - **Over Current** - An over-current condition occurred. See system administrator.
  - **Dead** - The battery has no charge. Replace the battery.
  - **Over Voltage** - An over-voltage condition occurred. See system administrator.
  - **Below Temperature** - The battery temperature is below the operating temperature. See system administrator.
  - **Failure Detected** - A failure has been detected in the battery. See system administrator.
  - **Unknown** - See system administrator.
- **Wear level** - Indicates the health of the battery in graphical form. When the wear level exceeds 80%, the bar color changes to red.

- **Advanced info** - Touch to view additional battery information.
  - **Battery present status** - Amount of usable charge remaining in the battery at present, under the current discharge conditions.
  - **Battery level** - Indicates battery charge level as a percentage of scale.
  - **Battery scale** - Battery scale level used to determine battery level (100).
  - **Battery voltage** - Indicates current battery voltage in millivolts.
  - **Battery temperature** - Indicates current battery temperature in degrees Centigrade.
  - **Battery technology** - Lists the type of battery.
  - **Battery manufacture date** - Lists the date of manufacture.
  - **Battery serial number** - Lists the battery serial number. The number matches the serial number printed on the battery label.
  - **Battery part number** - Lists the battery part number.
  - **Backup battery voltage** - Indicates the backup battery voltage in millivolts.
  - **Backup battery level** - Indicates the current backup battery charge level as a percentage.
  - **Battery rated capacity** - Lists the rated capacity of the backup battery in mAh.
  - **Battery decommission status** - Indicates if the battery is past its life span.
    - **Battery Good** - Battery is in good health.
    - **Decommissioned Battery** - Battery is past its useful life and should be replaced.
  - **Base cumulative charge** - Indicates the total amount of charge applied to the battery.
  - **Battery present capacity** - Maximum amount of charge that could be pulled from the battery under the present discharge conditions if the battery were fully charged.
  - **Battery health percentage** - With a range from 0 to 100, this is the ratio of "present\_capacity" to "design\_capacity" at a discharge rate of "design\_capacity".
  - **% decommission threshold** - Lists the default % decommission threshold for a gifted battery as 80%.
  - **Battery present charge** - Amount of usable charge remaining in the battery at present under the current discharge conditions.
  - **Battery total cumulative charge** - Lists the total accumulated charge in all chargers.
  - **Battery time since first use** - Lists the time passed since the battery was placed in a Zebra terminal for the first time.
  - **App version** - Lists the application version number.

## Device Central

Device Central displays detailed information about the WT6000 and connected peripherals and supports the following Zebra devices:

- RS507/RS507X Hands-free Imager
- RS6000 Bluetooth Ring Scanner
- RS5,000 Corded Ring Scanner
- HS3100 Bluetooth Headset
- DS3678 Digital Scanner.

Device Central features include:

- Discovering and pairing with supported peripherals via Bluetooth or corded connection.
- Paging a connected RS6000 Ring Scanner.
- Updating the firmware of supported ring scanners. For information on updating ring scanner firmware using Device Central, refer to the RS5,000 Quick Start Guide or RS6000 User Guide.
- Displaying the connection status of peripherals.
- Displaying information for a connected peripheral in the notification bar.

**Figure 59** Device Central Screen



## Device Central Tabs

- **Peripherals** Tab - displays all currently connected and previously connected peripherals. Connected peripherals display the length of time (in minutes) that they have been connected. When an RS6000 is connected the **Page** button displays. See [Paging an RS6000 Ring Scanner on page 76](#).  
Touch the peripheral information to display the **Device Details** screen.
  - **Device Details** - displays detailed device information for the selected peripheral.
- **My Device** Tab - displays information about the WT6000 and the current version of Device Central.
  - **Device Details** - displays the **About device** screen.
  - **Device Battery Details** - displays the **Battery** screen.

## Paging an RS6000 Ring Scanner

Use the **Page** button to easily locate the currently connected RS6000 Ring Scanner:

1. With the RS6000 Ring Scanner connected, swipe up from the bottom of the screen.

2. Touch .

✓ **NOTE:** The RS6000 Ring Scanner must be within 10 m (32 ft) of the WT6000.

3. Under the RS6000 peripheral information, touch **Page to begin paging the RS6000**. The paged RS6000 beeps and vibrates.


**Figure 60** Page RS6000



To stop paging, press the scan trigger of the RS6000. On a triggerless RS6000, stop paging by resetting the RS6000. See [Resetting the WT6000 on page 51](#).

## File Browser

Use the **File Browser** application to view and manage files on the device.


To open **File Browser**, swipe up from the bottom of the screen and touch .


**Figure 61** File Browser Screen




The address bar (1) indicates the current folder path. Touch the current folder path to manually enter a path and folder name.

Use  (2) to select multiple files/folder.

Use  (3) to view the internal storage root folder.

Use  (4) to view the Internal Storage root folder.

Use  (5) to view the previous folder or to exit the application.

Touch and hold an item to perform an operation on that item. Select one of the options from the **File Operations** menu:

- **Information** - View detailed information about the file or folder.
- **Move** - Move the file or folder to a new location.
- **Copy** - Copy the select file.
- **Delete** - Delete the selected file.
- **Rename** - Rename the select file.
- **Open as** - Open the selected file as a specific file type.
- **Share** - Share the file with other devices.


Touch  to open menu options:

- **New Folder** to create a new folder in the current folder.
- **Search** to search for a file or folder.
- **Sort** to sort the list by name, by type, by size or by date.
- **Refresh** to re-display the contents of the current folder.
- **List View** to change the folder view from tile to list format.
- **Change Size** to change the size of the icons: Large, Normal or Small.
- **About File Browser** to view the application version information.


---

## Contacts


Use the **Contacts** application to manage contacts.

From a Home or Apps screen, touch . **People** opens to the main list of contacts. View contacts in three ways at the top of the screen: **Groups**, **All contacts**, and **Favorites**. Touch the tabs to change how to view the contacts. Swipe up or down to scroll through the lists.


### Adding a Contact

1. In the **Contacts** application, touch .
2. If there are more than one account with contacts, touch the one to use.
3. Type the contact's name and other information. Touch a field to start typing, and swipe down to view all categories.
4. To open a menu with preset labels, such as **Home** or **Work** for an email address, touch the label to the right of the item of contact information. Or, to create your own label, touch **Custom** in the menu.
5. Touch the check mark next to **Add new contact**.

### Editing Contacts

1. In the **Contacts** application, touch a contact name to edit.
2. Touch .
3. Edit the contact information.
4. Touch the check mark next to **Edit contact**.

### Deleting Contacts

1. In the **Contacts** application, touch a contact name to delete.
2. Touch .
3. Touch **Delete**.
4. Touch **OK** to confirm.


## Gallery

- ✓ **NOTE:** The device supports the following image formats: jpeg, gif, png and bmp.  
The device supports the following video formats: H.263, H.264 and MPEG4 Simple Profile.

Use Gallery to:

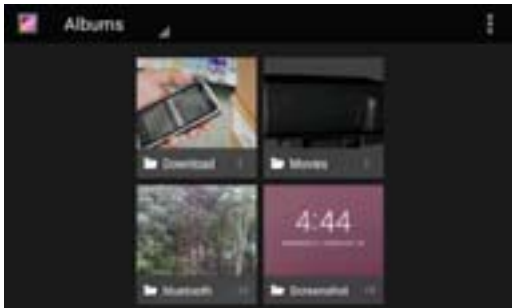
- view photos
- play videos
- perform basic editing of photos
- set photos as wallpaper
- set photos as a contact photo
- share photos and videos.


**Gallery** presents all photos and videos stored on the internal memory.

To open the Gallery application, swipe up from the bottom of the Home screen and touch .

By default, Gallery opens to the **Albums** view.

**Figure 62** Gallery - Albums



- Touch an album to open it and view its contents. The photos and videos in the album are displayed in chronological order.
- Touch a photo or video in an album to view it.
- Touch  to return to the main **Gallery** screen.

## Working with Albums



Albums are groups of images and videos in folders. Touch an album to open it. The photos and videos are listed in a chronologically ordered grid. The name of the album displays at the top of the screen.





**Figure 63** Photos Inside an Album

Swipe left or right to scroll images across the screen.

### Share an Album



1. Swipe up from the bottom of the Home screen and touch .
2. Touch and hold an album until it highlights.
3. Touch other albums as required.
4. Touch . The Share menu opens. Touch the application to use to share the selected albums.
5. Follow the instructions within the selected application.

### Get Album Information

1. Swipe up from the bottom of the Home screen and touch .
2. Touch and hold an album until it highlights.
3. Touch .
4. Touch **Details**.

### Deleting an Album

To delete an album and its contents:


1. Swipe up from the bottom of the Home screen and touch .
2. Touch and hold an album until it highlights.
3. Check other albums to delete. Ensure that other albums are selected.
4. Touch  > **Delete**.
5. In the **Delete selected item?** menu, touch **OK** to delete the album.

## Working with Photos

Use Gallery to view photos on the internal storage and edit and share photos.

### Viewing and Browsing Photos

To view a photo:




1. Swipe up from the bottom of the Home screen and touch .
2. Touch an album to open it.
3. Touch a photo.

**Figure 64** Photo Example



4. Swipe left or right to view the next or previous photo in the album.
5. Turn the device to view the photo in upright (portrait) or sideways (landscape) orientation. The photo is displayed (but not saved) in the new orientation.
6. Touch the photo to view the controls.
7. Double-tap the screen to zoom in or pinch two fingers together or spread them apart to zoom in or out.
8. Drag the photo to view parts that are not in view.

## Cropping a Photo


1. In Gallery, touch a photo to view the controls.
2. Touch  >  > . The cropping tool appears.
3. Use the cropping tool to select the portion of the photo to crop.
  - Drag from the inside of the cropping tool to move it.
  - Drag an edge of the cropping tool to resize it to any proportion.


**Figure 65** Cropping Tool





4. Touch the check mark > **SAVE** to save a copy of the cropped photo. The original version is retained.

## Setting a Photo as a Contact Icon



1. Swipe up from the bottom of the Home screen and touch .
2. Touch an album to open it.
3. Touch the photo to open it.

4. Touch .
5. Touch **Set picture as**.
6. Touch **Contact photo**.
7. In the **Contacts** application, touch a contact.
8. Touch the white box and crop the photo accordingly.
9. Touch **Save**.

## Share a Photo

1. Swipe up from the bottom of the Home screen and touch .
2. Touch an album to open it.
3. Touch a photo to open it.
4. Touch .
5. Touch the application to use to share the selected photo. The application selected opens with the photo attached to a new message.



## Deleting a Photo

1. Swipe up from the bottom of the Home screen and touch .
2. Touch an album to open it.
3. Touch a photo to open it.
4. Touch  > **Delete**.
5. In the **Delete selected item?** menu, touch **OK** to delete the photo.



## Working with Videos

Use **Gallery** to view videos and share videos.



### Watching Videos

1. Swipe up from the bottom of the Home screen and touch .
2. Touch an album to open it.
3. Touch a video.
4. Touch . The video begins to play.
5. Touch the screen to view the playback controls.

### Sharing a Video

1. Swipe up from the bottom of the Home screen and touch .
2. Touch an album to open it.
3. Touch a video to open it.
4. Touch . The Share menu appears.
5. Touch the application to use to share the selected video. The application selected opens with the video attached to a new message.

### Deleting a Video

1. Swipe up from the bottom of the Home screen and touch .
2. Touch an album to open it.
3. Touch a video to open it.
4. Touch  > **Delete**.
5. In the **Delete selected item?** menu, touch **OK** to delete the video.

## PTT Express Voice Client

- ✓ **NOTE:** PTT Express Voice Client creates Push-To-Talk (PTT) communication capability between disparate enterprise devices. Leveraging existing Wireless Local Area Network (WLAN) infrastructure, PTT Express delivers simple PTT communication without the need of a voice communication server.
- **Group Call:** Press and hold the PTT (Talk) button to start communicating with other voice client users.
- **Private Response:** Double-press and the PTT button to respond to the originator of the last broadcast or to make a Private Response.

### PTT Audible Indicators

The following tones provide helpful cues when using the voice client.

- **Talk Tone:** Double chirp. Plays when the Talk button is depressed. This is a prompt for the user to start talking.
- **Access Tone:** Single beep. Plays when another user just finished a broadcast or response. The user is now able to initiate a Group Broadcast or Private Response.
- **Busy Tone:** Continuous tone. Plays when the Talk button is depressed and another user is already communicating on the same talkgroup. Plays after the maximum allowed talk time is reached (60 seconds).
- Network Tone:
  - Three increasing pitch beeps. Plays when PTT Express has acquired the WLAN connection and the service is enabled.
  - Three decreasing pitch beeps. Plays when PTT Express has lost the WLAN connection or the service is disabled.

**Figure 66** PTT Express Default User Interface



**Table 10** PTT Express Default User Interface Descriptions

Item	Description
Notification Icon	Indicates the current state of the PTT Express client.
Service Indication	Indicates the status of the PTT Express client. Options: Service Enabled, Service Disabled or Service Unavailable.
Talk Groups	Lists all 32 Talk Groups available for PTT communication.








**Table 10** PTT Express Default User Interface Descriptions (Continued)

Item	Description
Settings	Opens the PTT Express Settings screen.
Enable/Disable Switch	Turns the PTT service on and off.


## Notification Icons

Indicates the current state of the PTT Express Voice client.

**Table 11** PTT Express Default User Interface Descriptions

Status Icon	Description
	Indicates that PTT Express Voice client is disabled.
	Indicates that PTT Express Voice client is enabled but not connected to a WLAN.
	Indicates that PTT Express Voice client is enabled, connected to a WLAN and listening on the Talk Group indicated by the number next to the icon.
	Indicates that PTT Express Voice client is enabled, connected to a WLAN and communicating on the Talk Group indicated by the number next to the icon.
	Indicates that PTT Express Voice client is enabled, connected to a WLAN and in a private response.
	Indicates that PTT Express Voice client is enabled and muted.
	Indicates that the PTT Express Voice client is enabled but it is not able to communicate due to a VoIP telephony call is in progress.

## Enabling PTT Communication

1. Swipe up from the bottom of the Home screen and touch .
2. Slide the **Enable/Disable Switch** to the **ON** position. The button changes to an **ON** button.

## Selecting a Talk Group

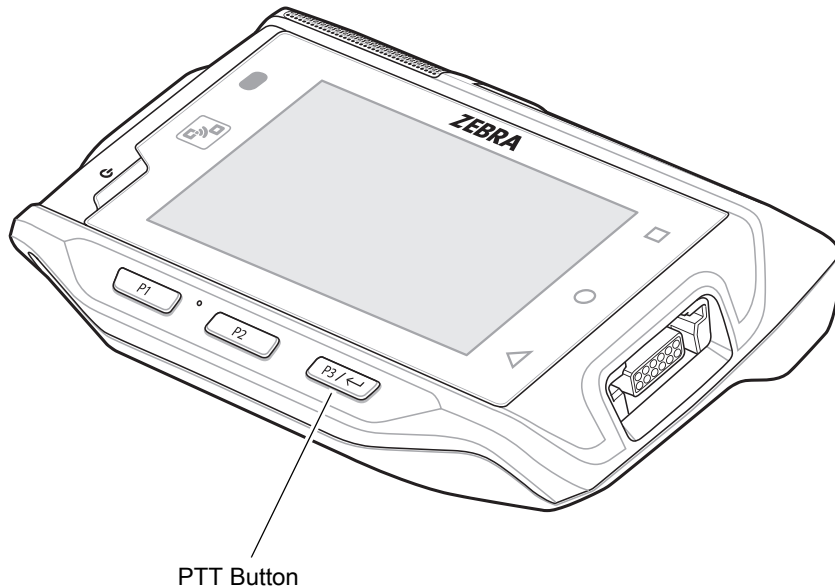
One of 32 Talk Groups can be selected by PTT Express users. However, only one talk group may be enabled at a time on the device. Touch one of the 32 Talk Groups. The selected Talk Group is highlighted.

## PTT Communication

- ✓ **NOTE:** This section describes the default PTT Express client configuration. See the PTT Express V1.2 User Guide for detailed information on using the client.

PTT communication may be established as a Group Call. When PTT Express is enabled, the P3 button is assigned for PTT communication.

**Figure 67** PTT Button



### Creating a Group Call

To create a group call:

1. Press and hold the PTT button and listen for the talk tone to play.  
If a busy tone is heard, release the button and wait a moment before making another attempt. Ensure that PTT Express and the WLAN are enabled.
2. Start talking after the talk tone is heard.

- ✓ **NOTE:** If the user holds the button for more than 60 seconds (default), the call is dropped allowing others to make Group calls. The user should release the button when finished talking to allow others to make calls.

3. Release the button when finished talking.



### Responding with a Private Response

The Private Response can only be initiated once a Group Call has been established. The initial Private Response is made to the originator of the Group Call.

1. Wait until an access tone is heard.
2. Within 10 seconds, double-press the PTT button, and listen for the talk tone to play.
3. If a busy tone is heard, release the button and wait a moment before making another attempt. Ensure that PTT Express and the WLAN are enabled.
4. Start talking after the talk tone plays.

5. Release the button when finished talking.

### Disabling PTT Express Voice Client Communication

1. Swipe up from the bottom of the Home screen and touch .
2. Slide the **Enable/Disable Switch** to the **OFF** position. The button changes to **OFF**.
3. Touch .



## DataWedge

Refer to the WT6000 Integrator Guide for detailed information on configuring DataWedge.

## DataWedge Demonstration

Use **DataWedge Demonstration** to demonstrate data capture functionality.

**Figure 68** DataWedge Demonstration Window



**Table 12** DataWedge Demonstration Icons

Feature	Icon	Description
Illumination		Select to disable imager illumination (RS507, RS5,000 and RS6000 only).
		Select to enable imager illumination (RS507, RS5,000 and RS6000 only).
Connection		Indicates that an RS507 or RS6000 Bluetooth imager is not connected to the WT6000.
		Indicates that an RS507 or RS6000 Bluetooth imager is connected to the WT6000.
		Indicates that an RS4000 laser scanner or RS5,000 imager is not connected to the WT6000.
		Indicates that an RS4000 laser scanner or RS5,000 imager is connected to the WT6000.
Scan Mode		Select to enable picklist mode (RS507, RS5,000 and RS6000 only).
		Select to enable normal scan mode (RS507, RS5,000 and RS6000 only).
Menu		Opens a menu to view the application information or to set the application DataWedge profile.

✓ **NOTE:** See WT6000 Integrator Guide for information on DataWedge configuration.

Either press the device Scan key or touch the yellow scan button in the application to enable data capture. The captured data appears in the text field below the yellow button.


## RxLogger

RxLogger is a comprehensive diagnostic tool that provides application and system metrics. It allows for custom plug-ins to be created and work seamlessly with this tool. RxLogger is used to diagnose device and application issues. Its information tracking includes the following: CPU load, memory load, memory snapshots, battery consumption, power states, wireless logging, cellular logging, TCP dumps, Bluetooth logging, GPS logging, logcat, FTP push/pull, ANR dumps, etc. All logs and files generated are saved onto flash storage on the device (internal or external).


**Figure 69** RxLogger



### Enabling Logging

1. Swipe up from the bottom of the Home screen and touch .
2. Touch **Start**.
3. Touch .

### Disabling Logging

1. Swipe up from the bottom of the Home screen and touch .
2. Touch **Stop**.
3. Touch .

---

## RxLogger Utility

RxLogger Utility is a data monitoring application for viewing logs in the device while RxLogger is running. The user can access the logs and RxLogger Utility features in the App View or the Overlay View.

In the App View the user views logs in the RxLogger Utility.


**Figure 70** RxLogger Utility App View



Refer to the WT6000 Touch Computer Integrator Guide for detailed information about using RxLogger Utility.

## Diagnostic Tool

The **Diagnostic Tool** is a utility that determines the health of the WT6000. Use the Diagnostic Tool to troubleshooting the device and determine issues.

1. Swipe up from the bottom of the Home screen and touch .

**Figure 71** Diagnostic Tool



2. Touch **Run Test**. The app tests all enabled subsystems (by default only the Battery and System tests are enabled). See [Settings on page 93](#) to enable subsystem tests.

**Figure 72** Test Passed Screen



**Figure 73** Test Failed Screen






3. To view each individual subsystem test, touch **Subsystem Tests**.

**Figure 74** Subsystem Screen



**Table 13** Subsystem Test Result Indicators

Status Icon	Description
	Indicates test passed.
	Indicates test failed.
	Indicates test not supported or not enabled.



4. Touch one of the subsystems to view details.

**Figure 75** Battery Subsystem Details



## Settings

By default only the Battery and System tests are enabled. To enable other tests:

1. Touch  > **Settings**.
2. Touch to the left of the test name. A green box with a checkmark appears.
3. Touch **SAVE**.
4. Touch **Yes** to confirm.
5. Touch .

## Battery Test Information

The Battery Test obtains the following information:

- **Battery Level** - Indicates the current battery charge level.

- **Battery Voltage** - Indicates the current battery voltage.
- **Status** - Indicates if the battery is charging (on AC power) or discharging (on battery power).
- **Power Source** - Indicates whether the device is receiving power from the battery or from an external source.
- **Temperature** - Indicates the current battery temperature.
- **Health Percentage** - Indicates the health of the battery.
- **Backup Battery Voltage** - Indicates backup battery voltage.
- **Manufacture Date** - Not applicable (Displays the manufacture date of the battery).

### GPS Test Information

Not supported on the WT6000.

### System Test Information

Use the System Test to determine if the CPU or memory loads are too high, there are too many processes running on the device, or that storage on the device is almost full. The System Test obtains the following information:

- **CPU Load** - Indicates the amount of CPU being used.
- **Free Physical Memory** - Indicates the amount of RAM available.
- **Free Storage** - Indicates the amount of internal Flash memory available.
- **Process Count** - Indicates the number of processes currently running.

### WLAN Test Information

If the WiFi radio is not present or disabled the test may be skipped. Use this information to determine if the device's WLAN configuration is correct or whether there is any connection with an access point or network. The WLAN Test obtains the following information:

- **WLAN Enabled** - Indicates if the WLAN radio is enabled or disabled.
- **WLAN Status** - Indicates the current status of association with the access point.
- **ESSID** - Displays the name of the wireless network.
- **BSSID** - Displays the MAC address of the connected access point.
- **MAC Address** - Displays the device's MAC address.
- **Signal** - Indicates the strength of the Wi-Fi signal (in dBm).
- **IP Address** - Displays the IP address of the device.

### WWAN Test Information

Not supported on the WT6000.

### Bluetooth Test Information

The Bluetooth Test obtains the following information:

- **Enabled** - Indicates if the Bluetooth radio is enabled or disabled.
- **Status** - Indicates if the device is paired to another Bluetooth device.
- **Connectable/Discoverable** - Indicates if the device is discoverable or connectable.
- **Address** - Displays the Bluetooth radio MAC address.
- **Name** - Displays the Bluetooth name for the device.

# Accessories

## Accessories

**Table 14** Accessories

Accessory	Part Number	Description
Cradles		
1-Slot WT6000 Charging Cradle	CRD-NGWT-1S1BU-01	Provides WT6000 and spare battery charging and USB communication with a host computer. Use with power supply, p/n PWRS-14000-148R and country specific grounded AC line cord.
2-Slot WT6000/RS6000 Charging Cradle	CRD-NWTRS-2SUCH-01	Provides WT6000 and RS6000 charging and USB communication with a host computer. Use with power supply, p/n PWRS-14000-148R and country specific grounded AC line cord.
5-Slot WT6000 Charge Only Cradle	CRD-NGWT-5S5BC-01	Charges up to five WT6000 devices and five spare batteries. Use with power supply, p/n PWRS-14000-241R, DC line cord, p/n 50-16002-029R and country specific grounded AC line cord.
10-Slot WT6000/RS6000 Charge Only Cradle	CRD-NWTRS-10SCH-01	Charges up to five WT6000 devices and up to five RS6000 scanners. Use with power supply, p/n PWRS-14000-241R, DC line cord, p/n 50-16002-029R and country specific grounded AC line cord.
10-Slot WT6000 Charge Only Cradle	CRD-NGWT-10SCH-01	Charges up to 10 WT6000 devices. Use with power supply, p/n PWRS-14000-241R, DC line cord, p/n 50-16002-029R and country specific grounded AC line cord.
5-Slot WT6000 Ethernet Cradle	CRD-NGWT-5S5BE-01	Charges up to five WT6000 devices and five spare batteries and provides Ethernet communication. Use with power supply, p/n PWRS-14000-241R, DC line cord, p/n 50-16002-029R and country specific grounded AC line cord.

**Table 14** Accessories (Continued)

Accessory	Part Number	Description
<b>Batteries and Chargers</b>		
Replacement Standard Battery	BTRY-NWTRS-33MA-01	Replacement standard 3,350 mAh battery for WT6000 and RS6000 (single pack).
Replacement Extended Battery	BTRY-NGWT-50MA-01	Replacement extended 5,000 mAh battery for WT6000 only (single pack).
4-Slot Battery Charger	SAC-NWTRS-4SCH-01	Charges up to four spare batteries. Requires power supply, p/n PWRS-14000-148R and country specific grounded AC line cord.
20-Slot Battery Charger	SAC-NWTRS-20SCH-01	Charges up to 20 spare batteries. Use with power supply, p/n PWRS-14000-241R, DC line cord, p/n 50-16002-029R and country specific grounded AC line cord.
<b>Mounting Brackets</b>		
Rack Mount Bracket	BRKT-SCRD-SMRK-01	Use for mounting a 5-Slot cradle or four 4-Slot Battery Chargers on a rack.
<b>Cables</b>		
Headset Adapter Cable with Quick Disconnect (Long)	CBL-NGWT-AUQDLG-01	Connects a wired headset to the WT6000 on a Hip Mount.
Headset Adapter Cable with Quick Disconnect (Short)	CBL-NGWT-AUQDST-01	Connects a wired headset to the WT6000 on a Wrist Mount.
USB/Charge Cable	CBL-NGWT-USBCHG-01	Provides USB communication and power to the WT6000. Requires power supply PWRS-14000-249R and country specific un-grounded AC line cord.
Vibrating Cable	CBL-NGWT-HDV BAP-01	Provides haptic notification feedback.
DC Y Cable	25-122026-02R	Provides power from the PWRS-14000-148R power supply to two 4-Slot Battery Chargers.
DC 4-way Cable	25-85992-01R	Provides power from the PWRS-14000-241R power supply to four 4-Slot Battery Chargers.
DC Line Cord	50-16002-029R	Provides power from the power supply to the 5-Slot Charge Only Cradle, 5-Slot Ethernet Cradle, 5-Slot Charge Only Cradle with Battery Charge and 5-Slot Ethernet Cradle with Battery Charger.
<b>Power Supplies</b>		
Power Supply	PWRS-14000-249R	Provides power to the device using the USB and Charging Cable. Requires country specific un-grounded AC line cord.
Power Supply	PWRS-14000-148R	Provides power to the 2-Slot cradles and 4-Slot Spare Battery Charger. Requires country specific grounded AC line cord.



## Accessories

**Table 14** Accessories (Continued)

Accessory	Part Number	Description
Power Supply	PWRS-14000-241R	Provides power to the 5-Slot Charge Only Cradle, 5-Slot Ethernet Cradle, 5-Slot Charge Only Cradle with Battery Charger and the 5-Slot Ethernet Cradle with Battery Charger. Requires DC Line Cord, p/n 50-16002-029R and country specific grounded AC line cord.
Miscellaneous		
Screen Protectors	MISC-WT6X-SCRN-01	Provides additional protection for display (5-pack).
Soft Goods		
WT6000 Hip Mount	SG-NGWT-HPMNT-01	Provides mounting the WT6000 on a belt.
WT6000 Wrist Mount (Small/Medium)	SG-NGWT-WRMTS-01	Replacement strap.
WT6000 Wrist Mount (Medium/Large)	SG-NGWT-WRMTL-01	Replacement strap.
WT6000 Spare Straps (Small/Medium)	SG-NGWT-WSTPST-01	Replacement strap.
WT6000 Spare Straps (Medium/Large)	SG-NGWT-WSTPLN-01	Replacement strap.
WT6000 Spare Comfort Pad	SG-NGWT-CMPD-01	Replacement Comfort Pad for the Wrist Mount.

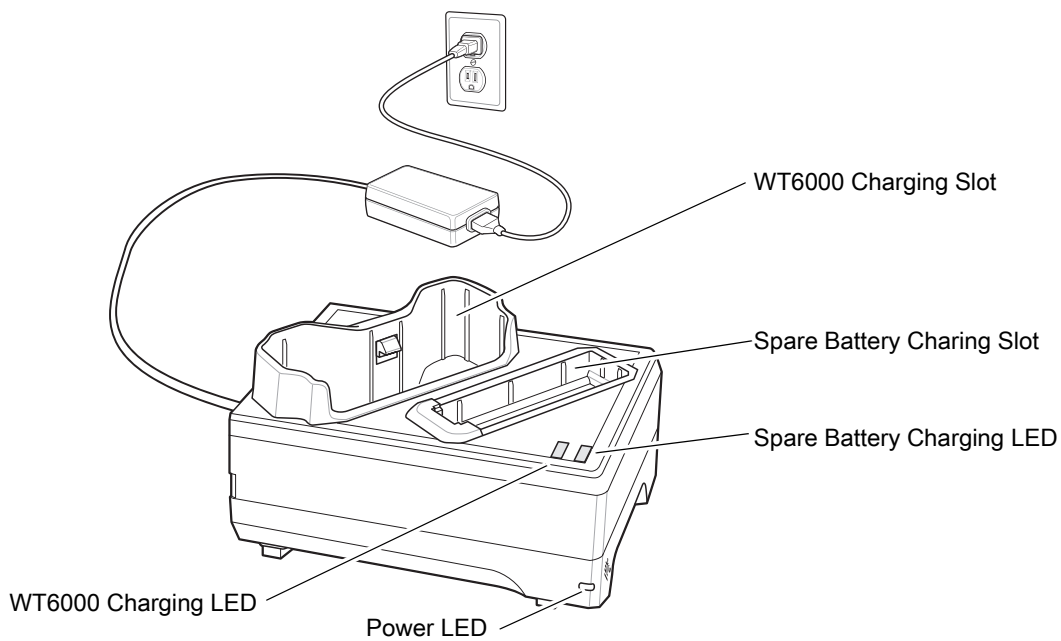
## 1-Slot WT6000 USB Charging Cradle

- ✓ **NOTE:** Ensure that you follow the guidelines for battery safety described in [Battery Safety Guidelines on page 135](#).

The 1-Slot WT6000 Charging Cradle:

- provides 5.4 VDC (nominal) power for operating the WT6000
- provides USB communication with a host computer
- charges a spare battery.

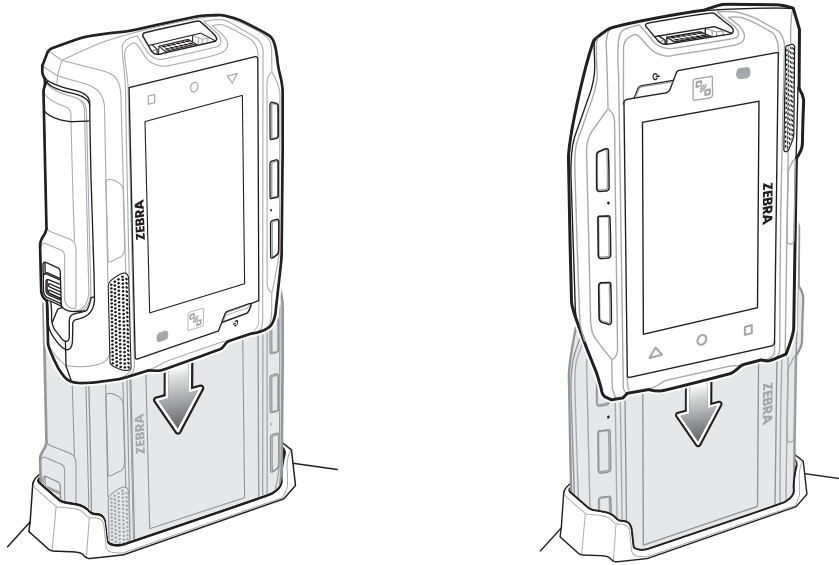
**Figure 76** 1-Slot WT6000 Charging Cradle



### Charging the Device

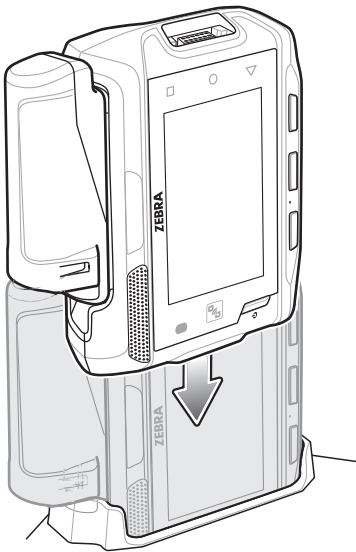
1. If charging a WT6000 with a standard battery, insert either end of the WT6000 into the WT6000 charging slot.

**Figure 77** Insert WT6000 with Standard Battery into Cradle



2. If charging a WT6000 with a extended battery, insert the end of the WT6000 into the WT6000 charging slot as shown below.

**Figure 78** Insert WT6000 with Extended Battery into Cradle

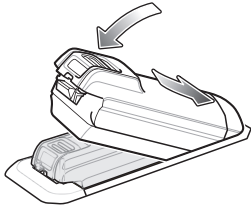


3. Ensure the WT6000 is seated properly. The WT6000 Charge LED blinks indicating charging.

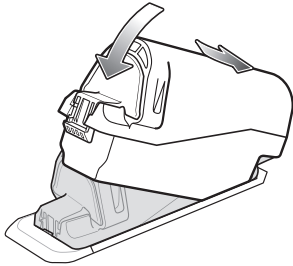
### Charging the Spare Battery

1. Insert a spare battery into the spare battery slot.

**Figure 79** Insert Standard Battery into Cradle



**Figure 80** Insert Extended Battery into Cradle



2. Ensure the battery is seated properly. The Spare Battery Charging LED blinks indicating charging.

## Battery Charging

The WT6000 Charging LED indicates the charging status of the battery in the WT6000 and the Spare Battery Charging LED indicates the charging status of the spare battery. See [Table 15 on page 100](#). The standard 3,350 mAh battery fully charges in less than four hours at room temperature. The extended 5,000 mAh battery fully charges in approximately five hours and 30 minutes at room temperature.

**Table 15** Charging LED Indicators

State	Indication
Off	The battery is not charging. The battery is not inserted correctly in the cradle or connected to a power source. Cradle is not powered.
Solid Amber	Battery is charging.
Solid Green	Battery charging is complete.
Fast Blinking Red (2 blinks/second)	Charging error, e.g.: - Temperature is too low or too high. - Charging has gone on too long without completion (typically eight hours).
Solid Red	Unhealthy battery is charging or fully charged.

Charge batteries in temperatures from 0°C to 40°C (32°F to 104°F). The device or cradle always performs battery charging in a safe and intelligent manner. At higher temperatures (e.g. approximately +37°C (+98°F)) the device or cradle may for small periods of time alternately enable and disable battery charging to keep the battery at acceptable temperatures. The device and cradle indicates when charging is disabled due to abnormal temperatures via its LED.

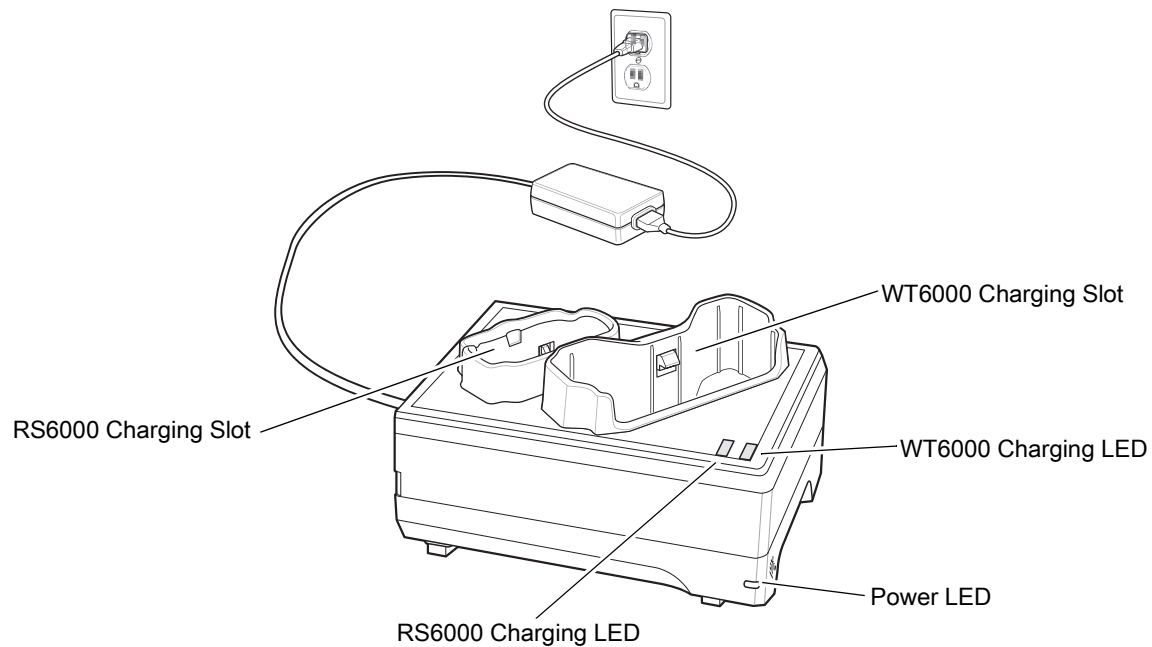
## 2-Slot WT6000/RS6000 Charging Cradle

- ✓ **NOTE:** Ensure that you follow the guidelines for battery safety described in [Battery Safety Guidelines on page 135](#).

The 2-Slot WT6000/RS6000 Charging Cradle:

- provides 5.4 VDC (nominal) power for operating the WT6000 and RS6000.

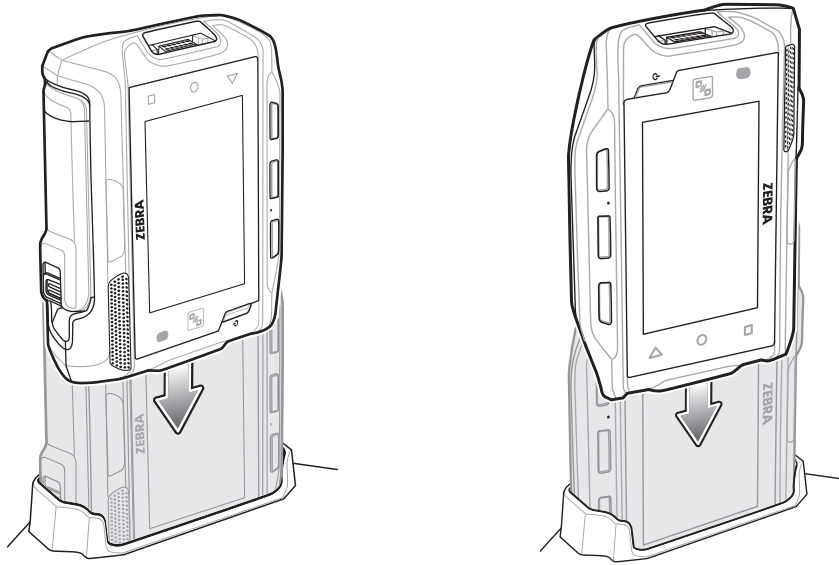
**Figure 81** 2-Slot WT6000/RS6000 Charging Cradle



### Charging the WT6000

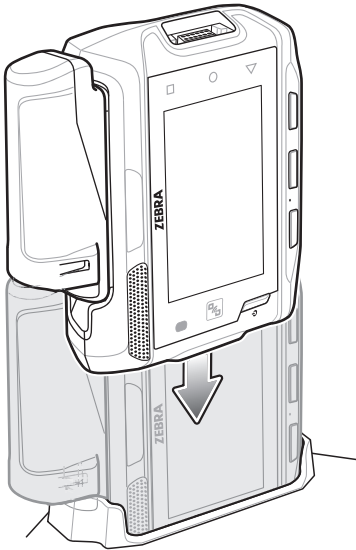
1. If charging a WT6000 with a standard battery, insert either end of the WT6000 into the WT6000 charging slot.

**Figure 82** Insert WT6000 with Standard Battery into Cradle



2. If charging a WT6000 with a extended battery, insert the end of the WT6000 into the WT6000 charging slot as shown below.

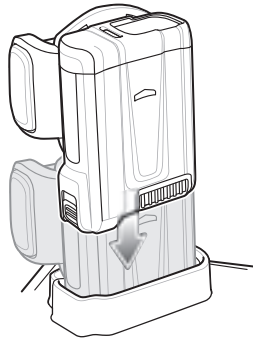
**Figure 83** Insert WT6000 with Extended Battery into Cradle



3. Ensure the WT6000 is seated properly. The WT6000 Charge LED blinks indicating charging.

### Charging the RS6000

1. Insert the RS600 into the RS6000 charging slot.

**Figure 84** Insert RS6000 into Cradle

2. Ensure the RS6000 is seated properly. The RS6000 Charging LED blinks indicating charging.

## Battery Charging

The WT6000 Charging LED indicates the charging status of the battery in the WT6000 and the RS6000 Charging LED indicates the charging status of the battery in the RS6000. See [Table 15 on page 100](#). The standard 3,350 mAh battery fully charges in less than four hours at room temperature. The extended 5,000 mAh battery fully charges in approximately five hours and 30 minutes at room temperature.

Charge batteries in temperatures from 0 °C to 40 °C (32 °F to 104 °F). The device or cradle always performs battery charging in a safe and intelligent manner. At higher temperatures (e.g. approximately +37 °C (+98 °F)) the device or cradle may for small periods of time alternately enable and disable battery charging to keep the battery at acceptable temperatures. The device and cradle indicates when charging is disabled due to abnormal temperatures via its LED.

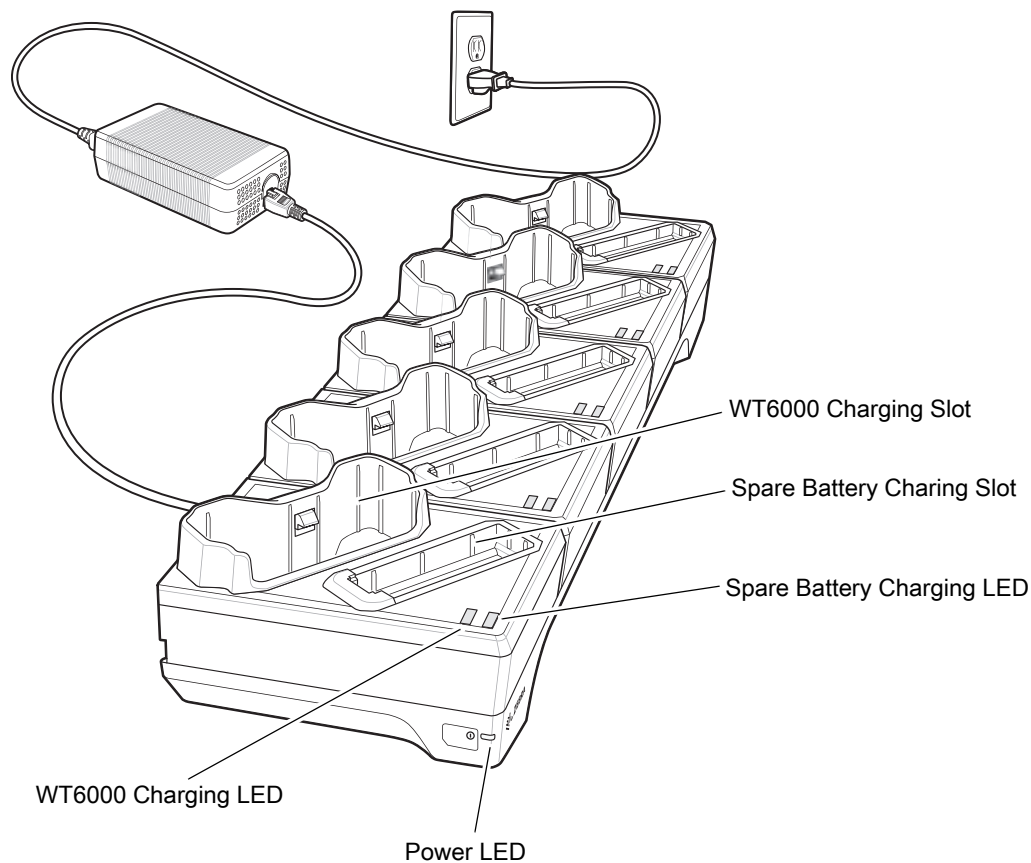
## 5-Slot WT6000 Charge Only Cradle

- ✓ **NOTE:** Ensure that you follow the guidelines for battery safety described in [Battery Safety Guidelines on page 135](#).

The 5-Slot Charge Only Cradle:

- Provides 5.4 VDC (nominal) power for operating up to five WT6000 devices.
- Simultaneously charges up to five WT6000 devices.
- Simultaneously charges up to five spare batteries.

**Figure 85** 5-Slot WT6000 Charge Only Cradle



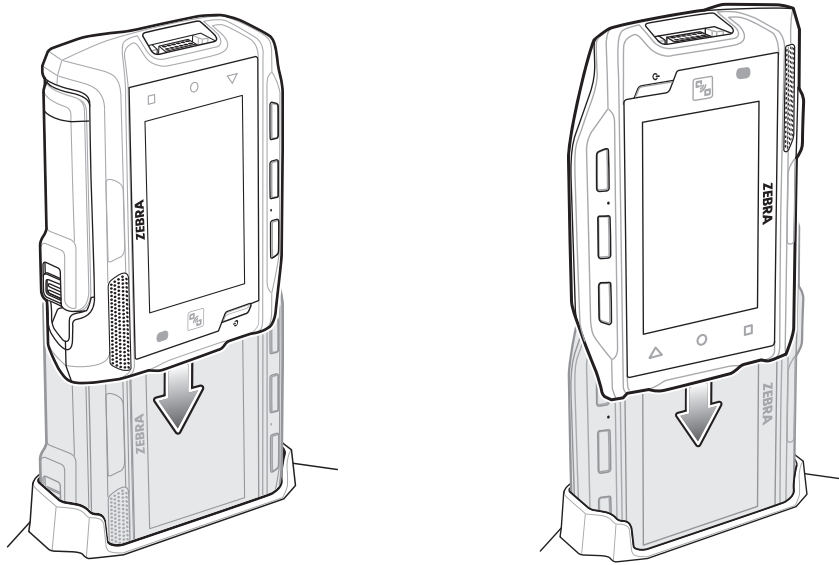
### Charging the WT6000

To Charge the WT6000:

1. If charging a WT6000 with a standard battery, insert either end of the WT6000 into the WT6000 charging slot.

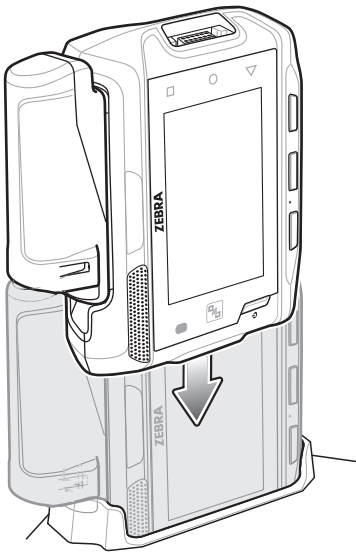


**Figure 86** Insert WT6000 with Standard Battery into Cradle



2. If charging a WT6000 with a extended battery, insert the end of the WT6000 into the WT6000 charging slot as shown below.

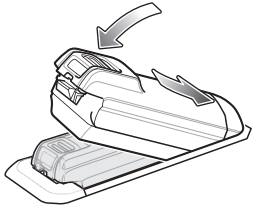
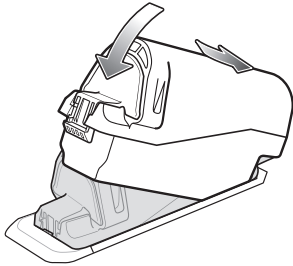
**Figure 87** Insert WT6000 with Extended Battery into Cradle



3. Ensure the WT6000 is seated properly. The WT6000 Charge LED blinks indicating charging.

### Charging the Spare Battery

1. Insert a spare battery into the spare battery slot.

**Figure 88** Insert Standard Battery into Cradle**Figure 89** Insert Extended Battery into Cradle

2. Ensure the battery is seated properly. The Spare Battery Charging LED blinks indicating charging.

## Battery Charging

The WT6000 Charging LED indicates the charging status of the battery in the WT6000 and the Spare Battery Charging LED indicates the charging status of the spare battery. See [Table 15 on page 100](#). The standard 3,350 mAh battery fully charges in approximately four hours at room temperature. The extended 5,000 mAh battery fully charges in approximately five hours and 30 minutes at room temperature.

Charge batteries in temperatures from 0 °C to 40 °C (32 °F to 104 °F). The device or cradle always performs battery charging in a safe and intelligent manner. At higher temperatures (e.g. approximately +37 °C (+98 °F)) the device or cradle may for small periods of time alternately enable and disable battery charging to keep the battery at acceptable temperatures. The device and cradle indicates when charging is disabled due to abnormal temperatures via its LED.

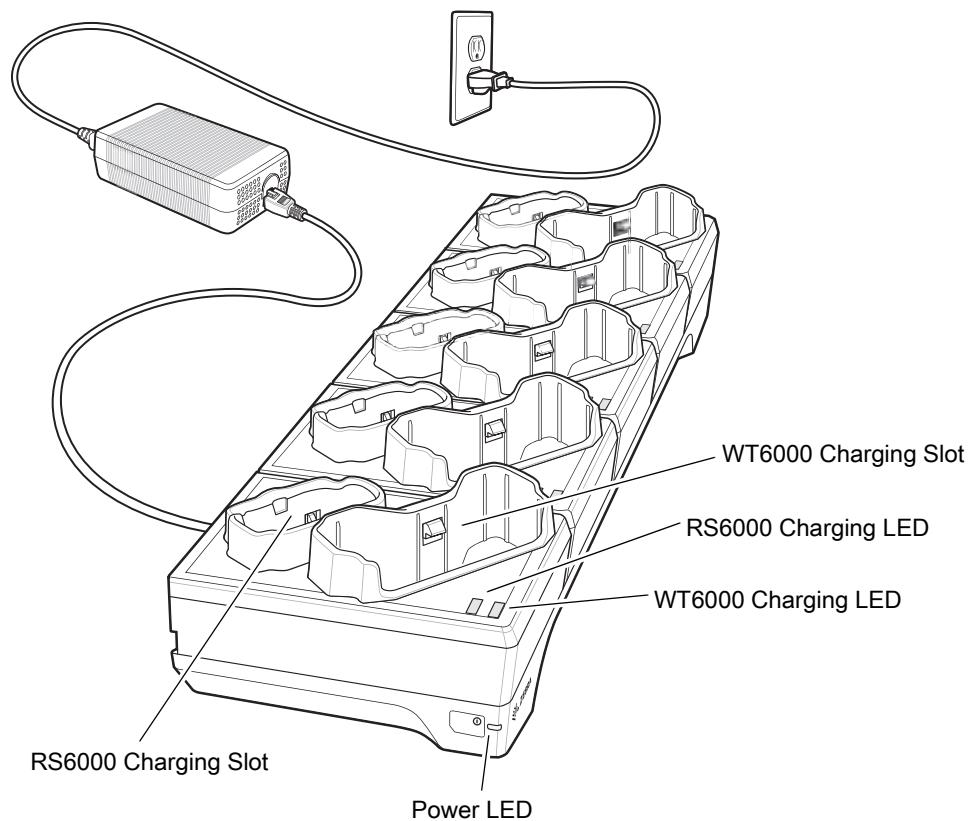
## 10-Slot WT6000/RS6000 Charge Only Cradle

- ✓ **NOTE:** Ensure that you follow the guidelines for battery safety described in [Battery Safety Guidelines on page 135](#).

The 10-Slot Charge Only Cradle:

- Provides 5.4 VDC (nominal) power for operating the WT6000 and RS6000.
- Simultaneously charges up to five WT6000 devices.
- Simultaneously charges up to five RS6000 devices.

**Figure 90** 10-Slot WT6000/RS6000 Charge Only Cradle

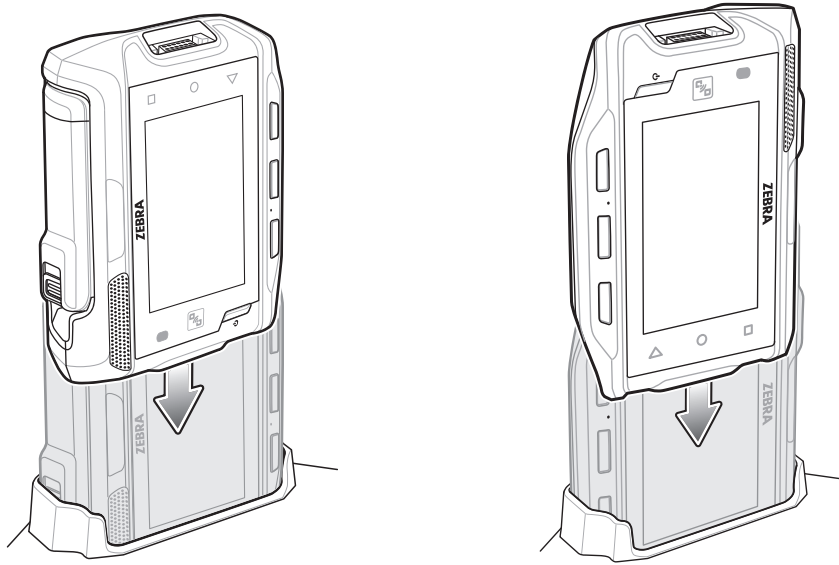


### Charging the WT6000

To Charge the WT6000:

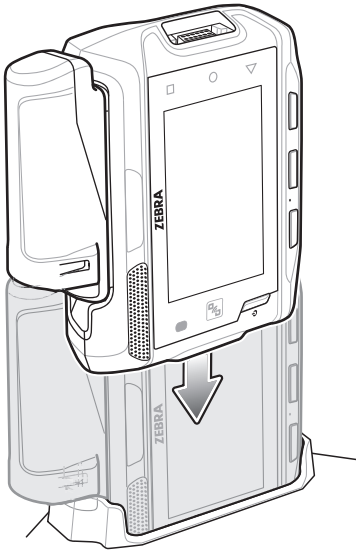
1. If charging a WT6000 with a standard battery, insert either end of the WT6000 into the WT6000 charging slot.

**Figure 91** Insert WT6000 with Standard Battery into Cradle



2. If charging a WT6000 with a extended battery, insert the end of the WT6000 into the WT6000 charging slot as shown below.

**Figure 92** Insert WT6000 with Extended Battery into Cradle



3. Ensure the WT6000 is seated properly. The WT6000 Charge LED blinks indicating charging.

### Charging the RS6000

1. Insert the RS600 into the RS6000 charging slot.

**Figure 93** Insert RS6000 into Cradle

2. Ensure the RS6000 is seated properly. The RS6000 Charging LED blinks indicating charging.

## Battery Charging

The WT6000 Charging LED indicates the charging status of the battery in the WT6000 and the RS6000 Charging LED indicates the charging status of the battery in the RS6000. See [Table 15 on page 100](#). The standard 3,350 mAh battery fully charges in approximately four hours at room temperature. The extended 5,000 mAh battery fully charges in approximately five hours and 30 minutes at room temperature.

Charge batteries in temperatures from 0°C to 40°C (32°F to 104°F). The battery charger always performs battery charging in a safe and intelligent manner. At higher temperatures (e.g. approximately +37°C (+98°F)) the battery charger may for small periods of time alternately enable and disable battery charging to keep the battery at acceptable temperatures. The battery charger indicates when charging is disabled due to abnormal temperatures via its LED.

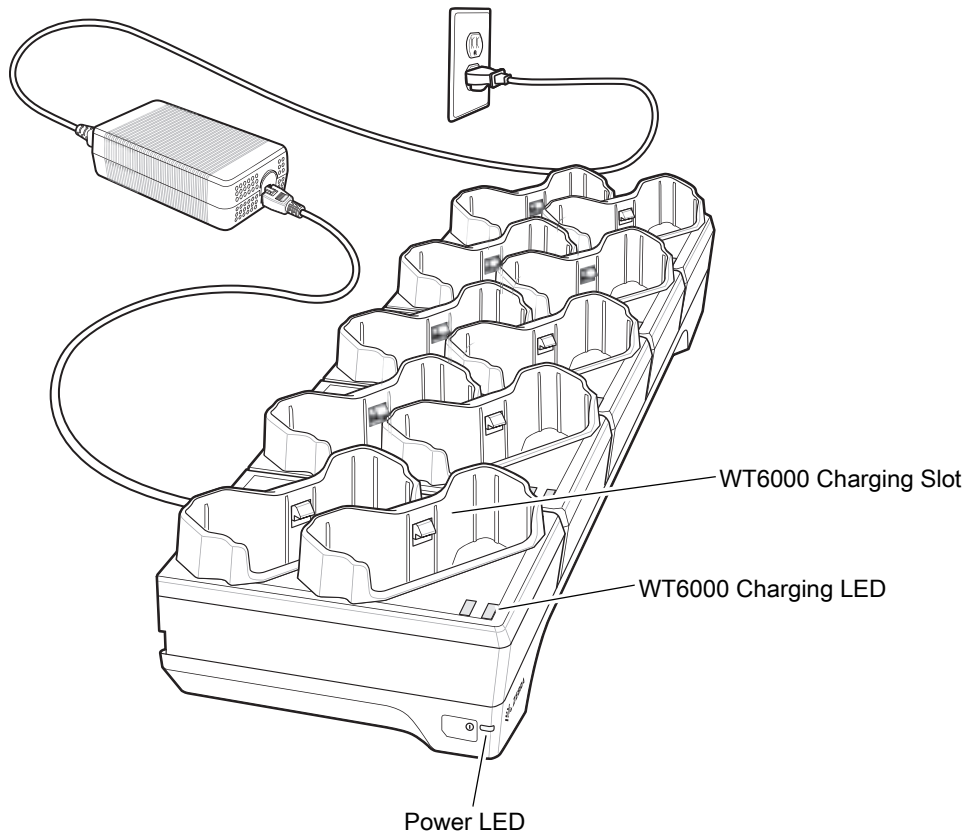
## 10-Slot WT6000 Charge Only Cradle

- ✓ **NOTE:** Ensure that you follow the guidelines for battery safety described in [Battery Safety Guidelines on page 135](#).

The 10-Slot WT6000 Charge Only Cradle:

- Provides 5.4 VDC (nominal) power for operating the WT6000.
- Simultaneously charges up to 10 WT6000 devices.

**Figure 94** 10-Slot WT6000 Charge Only Cradle

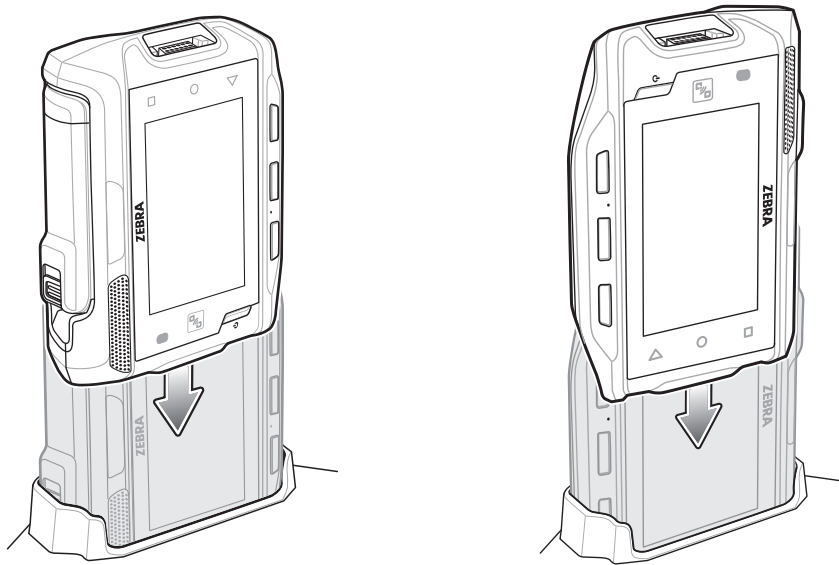


### Charging the WT6000

To Charge the WT6000:

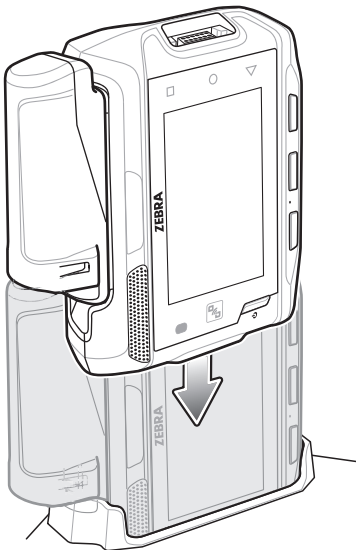
1. If charging a WT6000 with a standard battery, insert either end of the WT6000 into the WT6000 charging slot.

**Figure 95** Insert WT6000 with Standard Battery into Cradle



2. If charging a WT6000 with a extended battery, insert the end of the WT6000 into the WT6000 charging slot as shown below.

**Figure 96** Insert WT6000 with Extended Battery into Cradle



3. Ensure the WT6000 is seated properly. The WT6000 Charge LED blinks indicating charging.

## Battery Charging

The WT6000 Charging LED indicates the charging status of the battery in the WT6000. See [Table 15 on page 100](#). The standard 3,350 mAh battery fully charges in less than four hours at room temperature. The extended 5,000 mAh battery fully charges in approximately five hours and 30 minutes at room temperature.

Charge batteries in temperatures from 0 °C to 40 °C (32 °F to 104 °F). The battery charger always performs battery charging in a safe and intelligent manner. At higher temperatures (e.g. approximately +37 °C (+98 °F)) the battery charger may for small periods of time alternately enable and disable battery charging to keep the battery at acceptable temperatures. The battery charger indicates when charging is disabled due to abnormal temperatures via its LED.

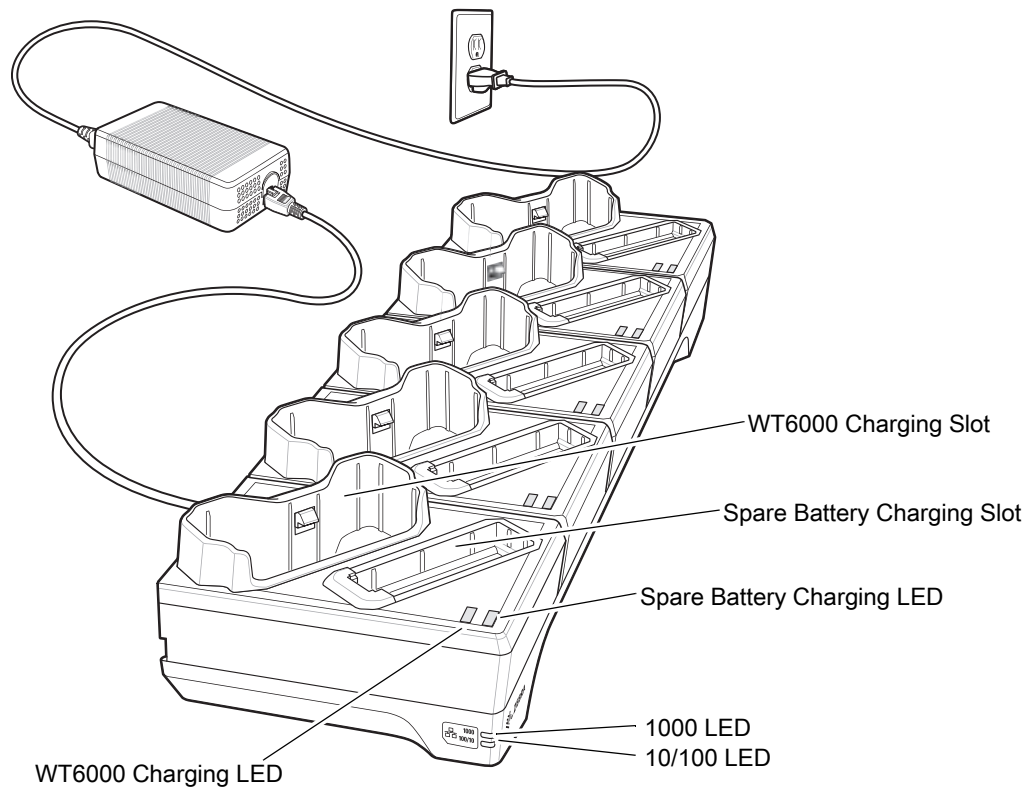
## 5-Slot WT6000 Ethernet Cradle

✓ **NOTE:** Ensure that you follow the guidelines for battery safety described in [Battery Safety Guidelines on page 135](#).

The 5-Slot WT6000 Ethernet Cradle:

- Provides 5.4 VDC (nominal) power for operating the WT6000.
- Connects up to five WT6000 devices to an Ethernet network.
- Simultaneously charges up to five WT6000 devices.
- Simultaneously charges up to five spare batteries.

**Figure 97** 5-Slot WT6000 Ethernet Cradle



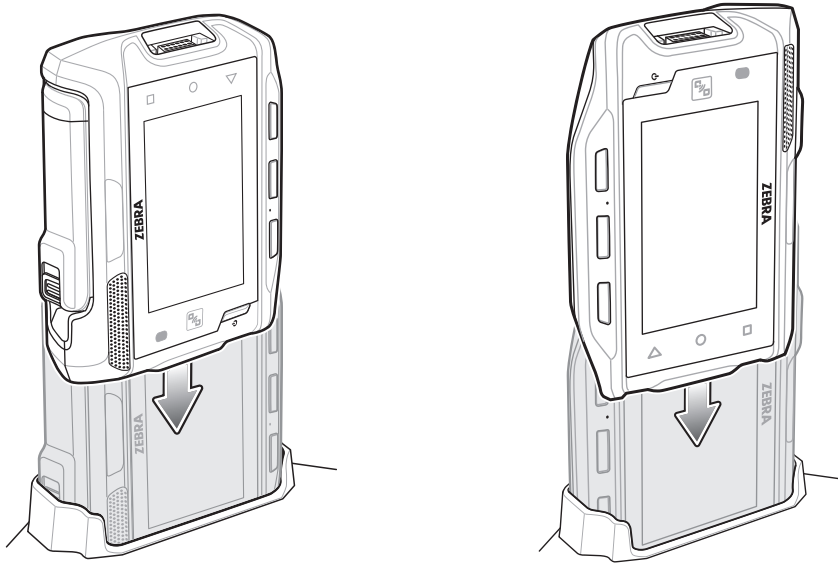
### Charging the WT6000

To charge the WT6000:

1. If charging a WT6000 with a standard battery, insert either end of the WT6000 into the WT6000 charging slot.

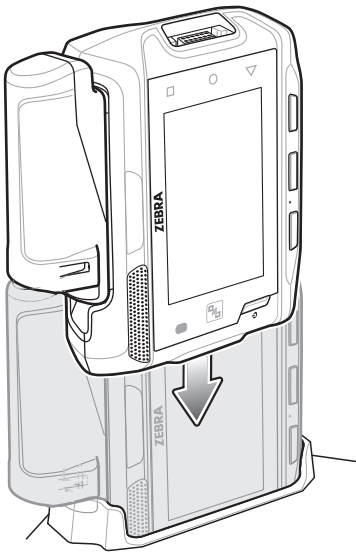


**Figure 98** Insert WT6000 with Standard Battery into Cradle



2. If charging a WT6000 with a extended battery, insert the end of the WT6000 into the WT6000 charging slot as shown below.

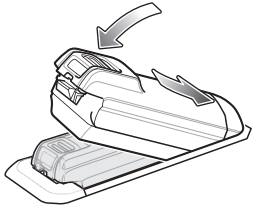
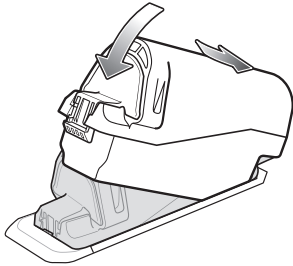
**Figure 99** Insert WT6000 with Extended Battery into Cradle



3. Ensure the WT6000 is seated properly. The WT6000 Charge LED blinks indicating charging.

### Charging the Spare Battery

1. Insert a spare battery into the spare battery slot.

**Figure 100** Insert Standard Battery into Cradle**Figure 101** Insert Extended Battery into Cradle

2. Ensure the battery is seated properly. The Spare Battery Charging LED blinks indicating charging.



## Battery Charging

The WT6000 Charging LED indicates the charging status of the battery in the WT6000 and the Spare Battery Charging LED indicates the charging status of the spare battery. See [Table 15 on page 100](#). The standard 3,350 mAh battery fully charges in less than four hours at room temperature. The extended 5,000 mAh battery fully charges in approximately five hours and 30 minutes at room temperature.

Charge batteries in temperatures from 0 °C to 40 °C (32 °F to 104 °F). The battery charger always performs battery charging in a safe and intelligent manner. At higher temperatures (e.g. approximately +37 °C (+98 °F)) the battery charger may for small periods of time alternately enable and disable battery charging to keep the battery at acceptable temperatures. The battery charger indicates when charging is disabled due to abnormal temperatures via its LED.

## Establishing Ethernet Communication

✓ **NOTE:** Refer to the WT6000 Integrator Guide for information on configuring the Ethernet settings.

1. Touch .
2. Touch **Ethernet Setting**.
3. Slide the Ethernet switch to the **ON** position.
4. Insert the device into a slot.
5. The  icon appears in the Status bar.
6. Touch **Eth0** to view Ethernet connection details.

### Ethernet LED Indicators

There are two green LEDs on the side of the cradle. These green LEDs light and blink to indicate the data transfer rate.

**Table 16** LED Data Rate Indicators

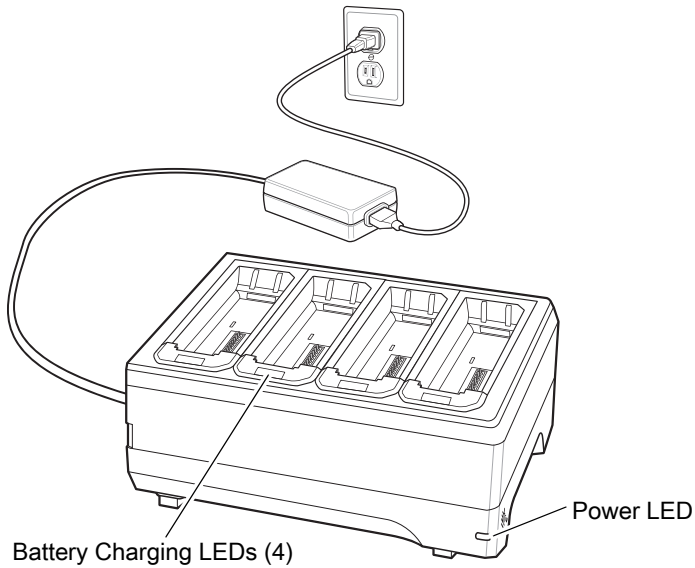
Data Rate	1000 LED	100/10 LED
1 Gbps	On/Blink	Off
100 Mbps	Off	On/Blink
10 Mbps	Off	On/Blink

## 4-Slot Battery Charger

- ✓ **NOTE:** Ensure that you follow the guidelines for battery safety described in [Battery Safety Guidelines on page 135](#).

The 4-Slot Battery Charger charges up to four spare batteries.

**Figure 102** 4-Slot Battery Charger

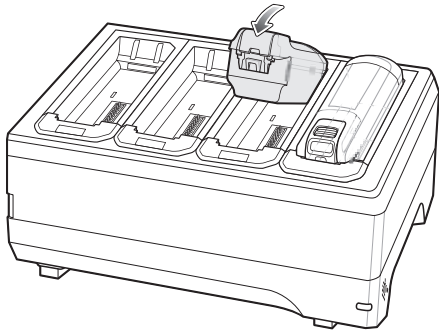


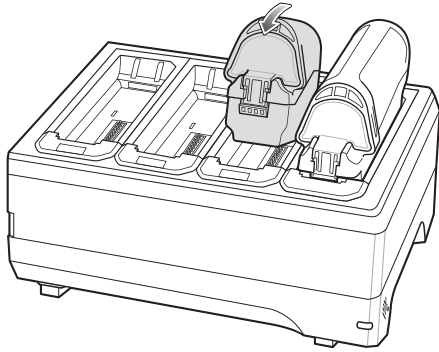
## Battery Installation

To install the battery:

1. Insert the battery into a battery slot.
2. Gently press down on the battery until it snaps into place.

**Figure 103** Insert Standard Battery into Slot



**Figure 104** Insert Extended Battery into Slot

## Battery Removal

To remove the battery, press the battery release latch toward the end of the battery and lift the battery out of the battery slot.

## Battery Charging

### Spare Battery Charging

Each Battery Charging LED indicates the status of the battery charging in each slot. See [Table 15 on page 100](#). The standard 3,350 mAh battery fully charges in less than four hours at room temperature. The extended 5,000 mAh battery fully charges in approximately five hours and 30 minutes at room temperature.

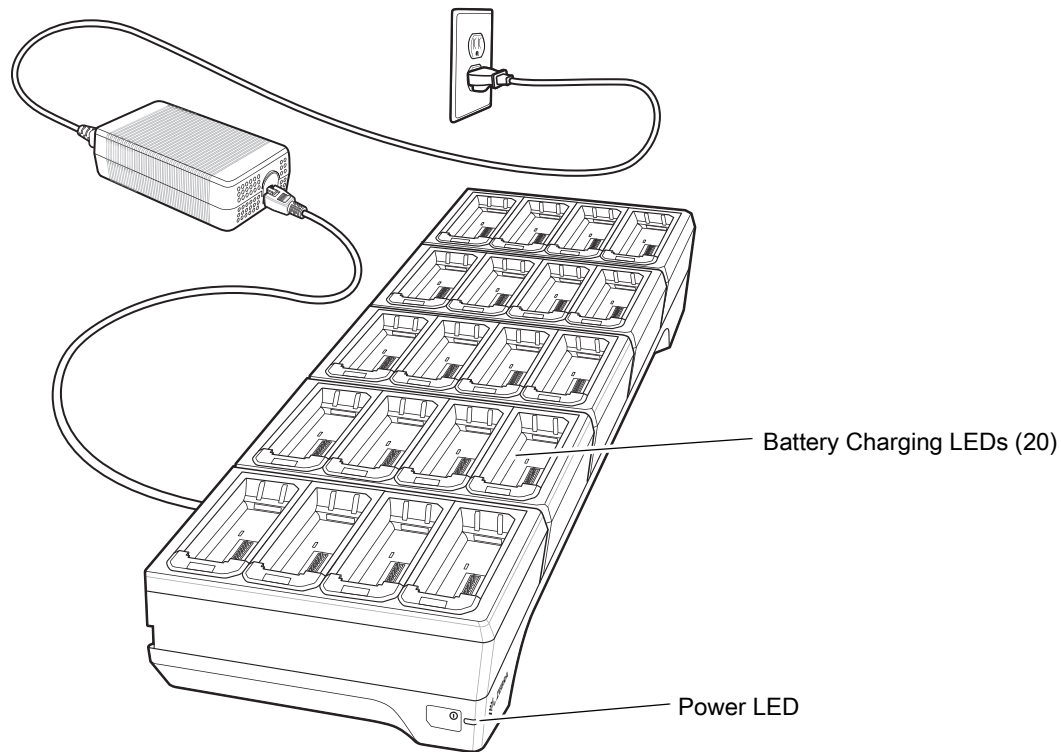
Charge batteries in temperatures from 0 °C to 40 °C (32 °F to 104 °F). The battery charger always performs battery charging in a safe and intelligent manner. At higher temperatures (e.g. approximately +37 °C (+98 °F)) the battery charger may for small periods of time alternately enable and disable battery charging to keep the battery at acceptable temperatures. The battery charger indicates when charging is disabled due to abnormal temperatures via its LED.

## 20-Slot Battery Charger

- ✓ **NOTE:** Ensure that you follow the guidelines for battery safety described in [Battery Safety Guidelines on page 135](#).

The 20-Slot Battery Charger charges up to 20 spare batteries.

**Figure 105** 20-Slot Battery Charger

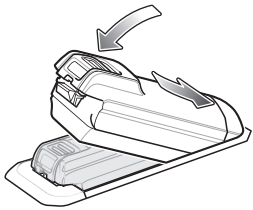


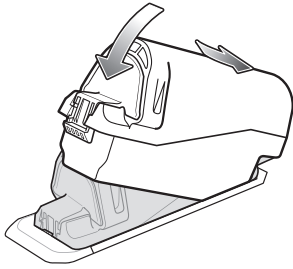
## Battery Installation

To install the battery:

1. Insert the battery into a battery slot.
2. Gently press down on the battery until it snaps into place.

**Figure 106** Insert Standard Battery into Slot



**Figure 107** Insert Extended Battery into Slot

## Battery Removal

To remove the standard battery, press the battery release latch toward the end of the battery and lift the battery out of the battery slot.

## Battery Charging

### Spare Battery Charging

Each Battery Charging LED indicates the status of the battery charging in each slot. See [Table 15 on page 100](#). The standard 3,350 mAh battery fully charges in less than four hours at room temperature. The extended 5,000 mAh battery fully charges in approximately five hours and 30 minutes at room temperature.

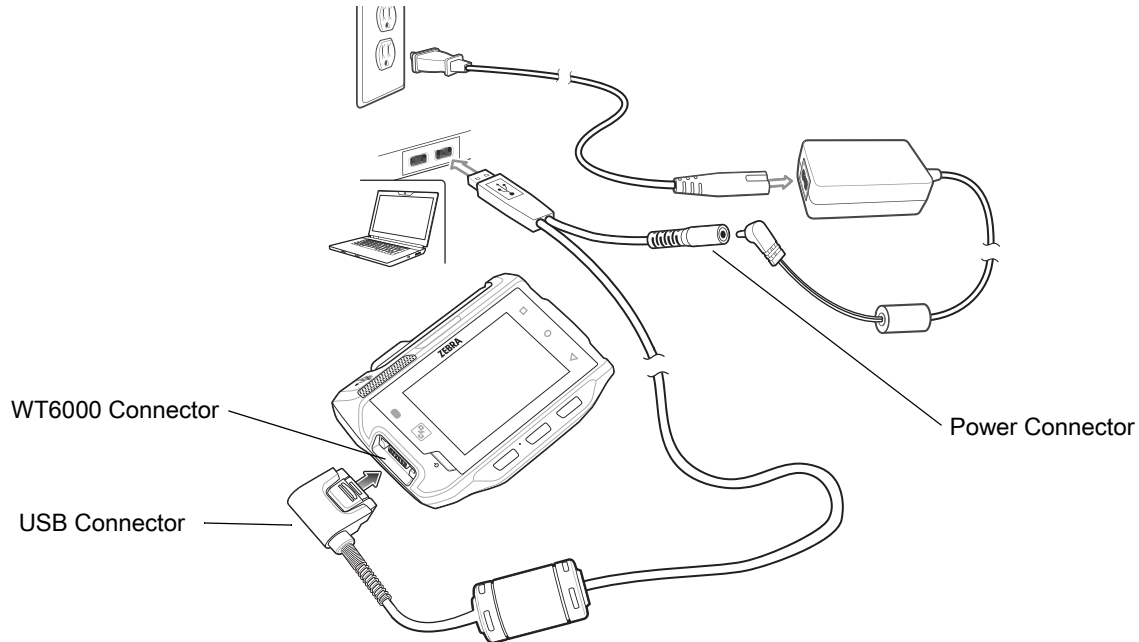
Charge batteries in temperatures from 0°C to 40°C (32°F to 104°F). The battery charger always performs battery charging in a safe and intelligent manner. At higher temperatures (e.g. approximately +37°C (+98°F)) the battery charger may for small periods of time alternately enable and disable battery charging to keep the battery at acceptable temperatures. The battery charger indicates when charging is disabled due to abnormal temperatures via its LED.

## USB and Charging Cable

- ✓ **NOTE:** Ensure that you follow the guidelines for battery safety described in [Battery Safety Guidelines on page 135](#).

The USB and Charging cable connects to either interface connector on the WT6000. When attached to the WT6000, allows the WT6000 to transfer data to a host computer and provide power for charging the WT6000.

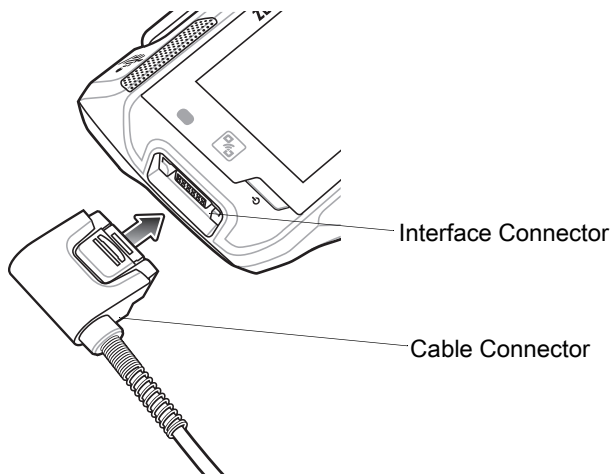
**Figure 108** USB and Charging Cable



## Attaching the USB and Charging Cable

1. Connect the connector to the WT6000 interface connector.

**Figure 109** Connecting Scanner to WT6000



2. Attach the USB connection to the host computer.



## Removing the USB and Charging Cable

To remove the USB and Charging cable:

1. Press the release level toward the cable.
2. Rotate the adapter toward the front of the device and remove.

## Battery Charging

To charge the WT6000, attached the power cable to the Power Connection on the USB and Charging Cable.

### Main Battery Charging

The WT6000 Charging/Scan LED indicates the status of the battery charging in the device. See [Table 3 on page 18](#). The standard 3,350 mAh battery fully charges in less than four hours at room temperature. The extended 5,000 mAh battery fully charges in approximately five hours and 30 minutes at room temperature.

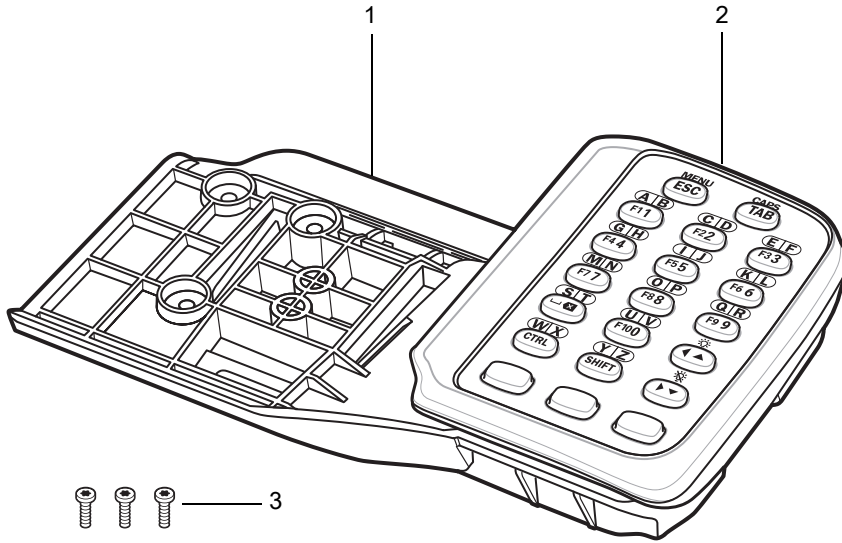
## Charging Temperature

Charge batteries in temperatures from 0°C to 40°C (32°F to 104°F). The battery charger always performs battery charging in a safe and intelligent manner. At higher temperatures (e.g. approximately +37°C (+98°F)) the battery charger may for small periods of time alternately enable and disable battery charging to keep the battery at acceptable temperatures. The battery charger indicates when charging is disabled due to abnormal temperatures via its LED.

## Keypad

Before installing the keypad, update the WT6000 to LifeGuard Update 13 or later. For information on updating the WT6000, see the WT6000 Wearable Computer Integrator Guide for Android 7.1.1 Nougat.

**Figure 110** Keypad

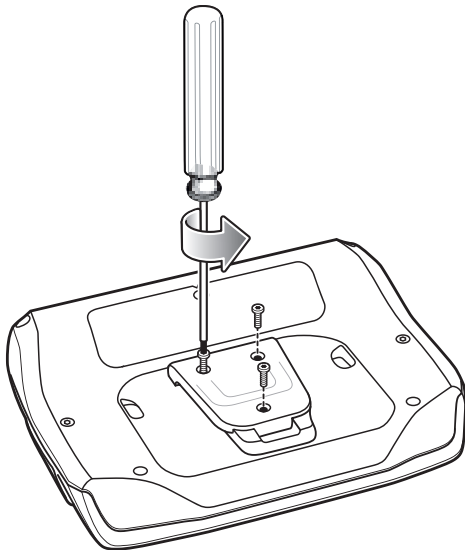


1	Keypad Mount
2	WT6000 Keypad
3	Installation Screws

## Installing the Keypad

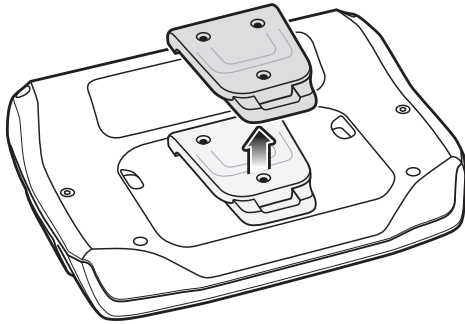
1. Using a T6 Torx screwdriver, remove the screws from cleat on the back of the WT6000.

**Figure 111** Remove Screws from Cleat



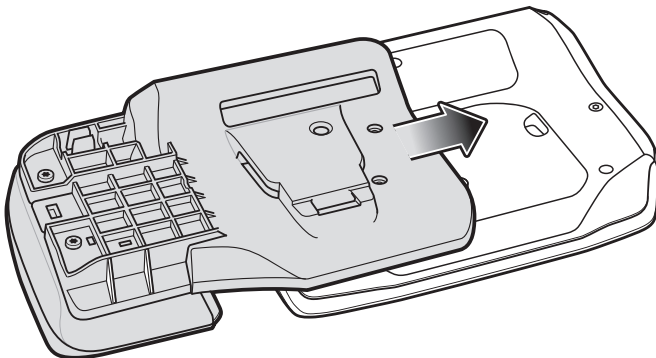
2. Lift cleat from the back of the WT6000.

**Figure 112** Remove Cleat



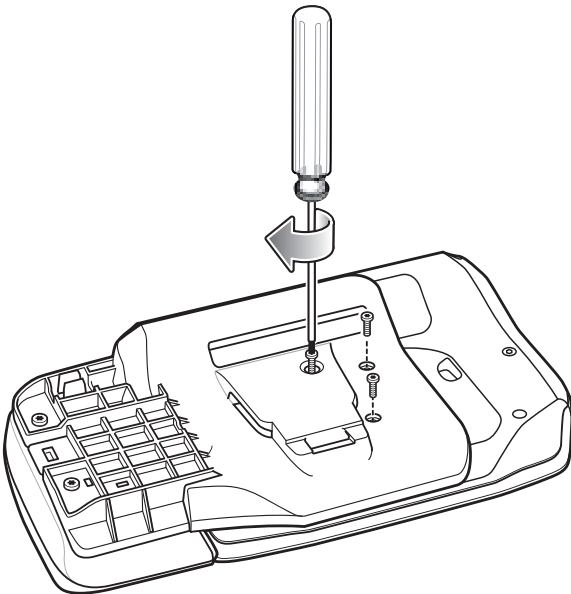
3. Slide the keypad mount onto the WT6000.

**Figure 113** Attach Keypad Mount



4. Secure the keypad mount by installing the three screws using a T6 Torx screwdriver.

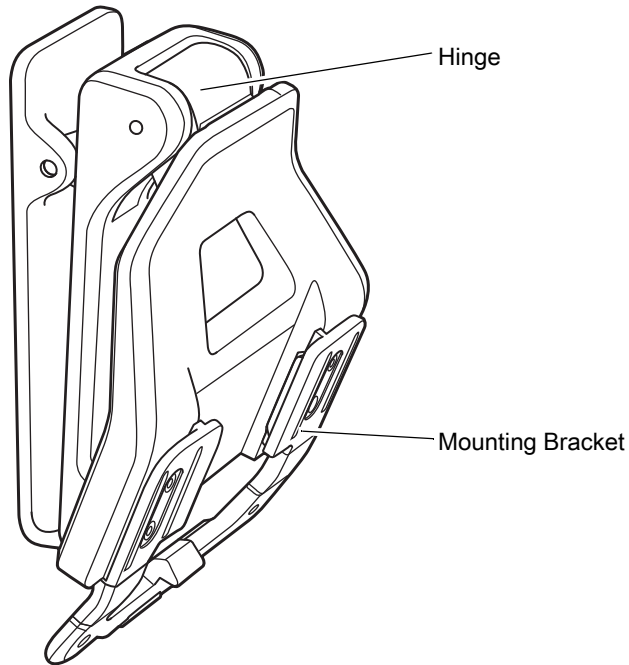
**Figure 114** Secure Mount



## Hip Mount

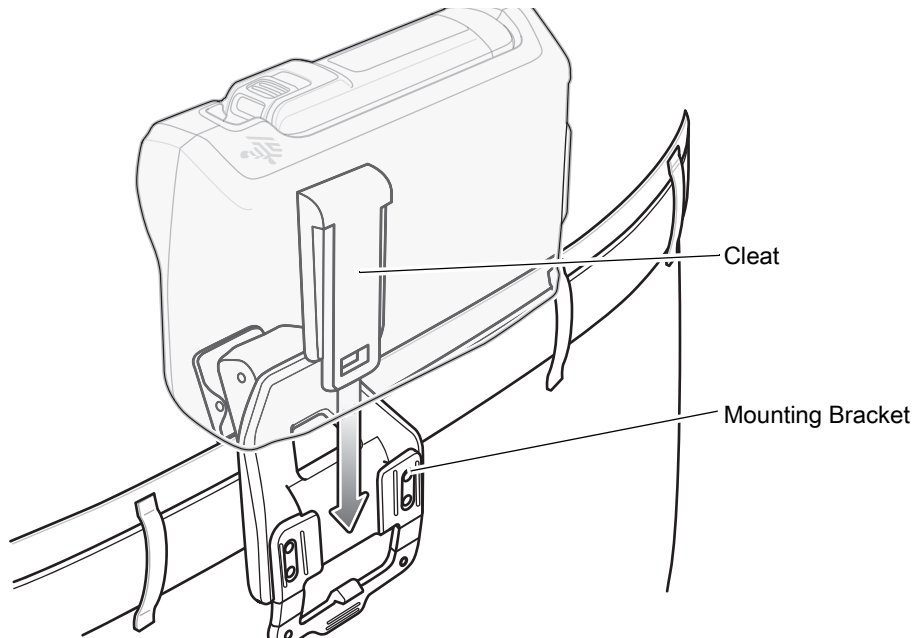
The hip mount allows the user to mount the WT6000 on the belt for use in voice picking applications. An RS4000 or RS5000 scanner with an extended cable, a wired headset or the RS6000 Hands-free Bluetooth Imager is required when using the hip mount.

**Figure 115** Hip Mount



1. Attach the Hip Mount to belt.
2. Align the cleat on the WT6000 with the mounting bracket on the Hip Mount.
3. Slide the WT6000 into the hip mount.

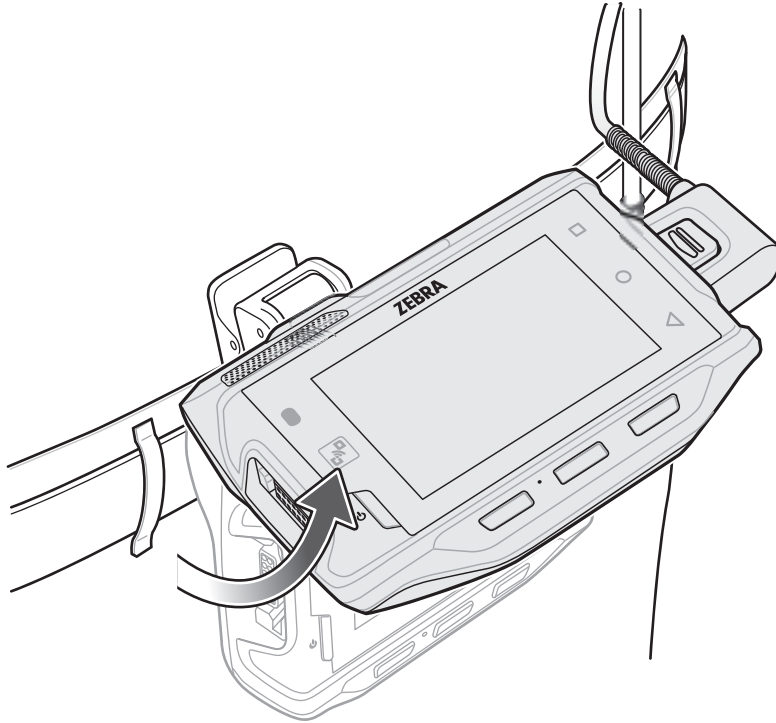
**Figure 116** Insert WT6000 onto Hip Mount



4. Connect RS4000, RS5000 or headset to the WT6000.

The Hip Mount provides a hinged bracket so the user can easily view the display by lifting the WT6000.

**Figure 117** Lift WT6000 to View Display

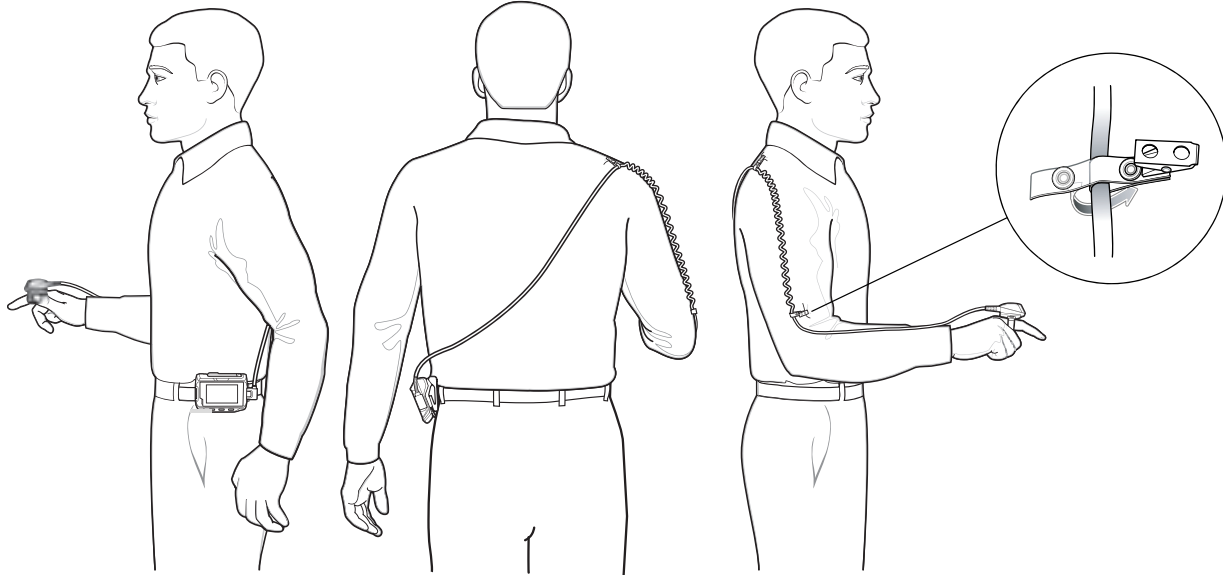


## Routing an Extended Cable Scanner

When using an RS4000 or RS5000 scanner with the WT6000 mounted on the hip, the extended cable version is required.

Zebra offers for sale cable clips, which attach to clothing and hold the scanner cable so that the cable does not interfere with the user. The cable clips are similar to badge clips and can be purchased at any office supply store as well.

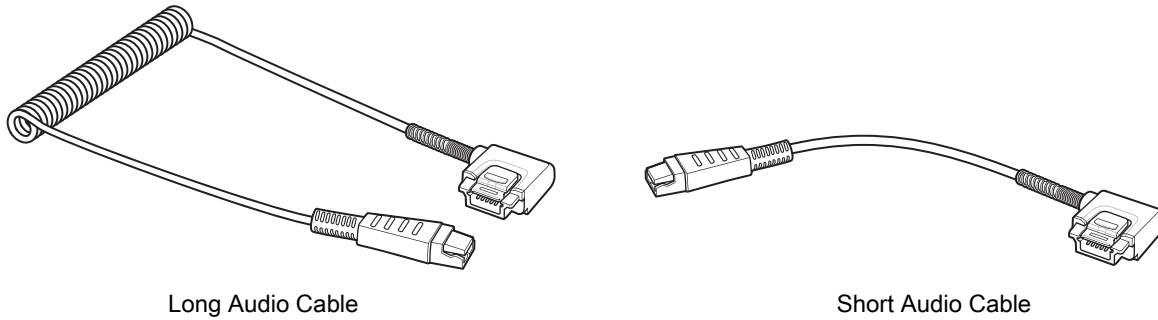
**Figure 118** Routing RS4000 Scanner Cable from Hip to Hand



## Quick Disconnect Audio Cables

The Quick Disconnect Audio Adapter snaps into either interface connector. When attached to the WT6000, the Quick Disconnect Audio Adapter allows a user to connect a wired headset to the WT6000.

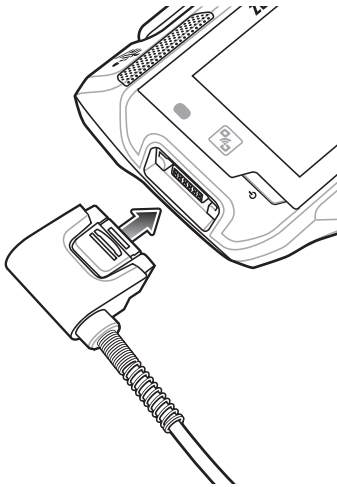
**Figure 119** Audio Cables



## Attaching the Audio Adapter

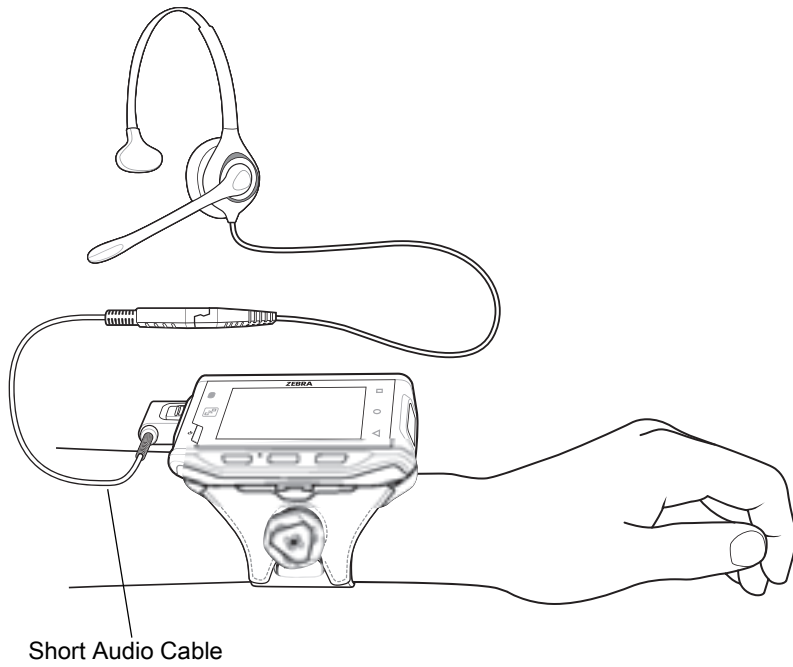
1. Align the tabs on the Audio Adapter with the slots on the device.
2. Rotate the Adapter toward the back of the device until the Adapter snaps onto the device.

**Figure 120** Attach Cable to WT6000



## Connecting the Audio Cable to a Headset

**Figure 121** Short Quick Disconnect Audio Cable Connection to Headset



**Figure 122** Long Quick Disconnect Audio Cable Connection to Headset





## Removing the Audio Adapter

To remove the Audio Adapter:

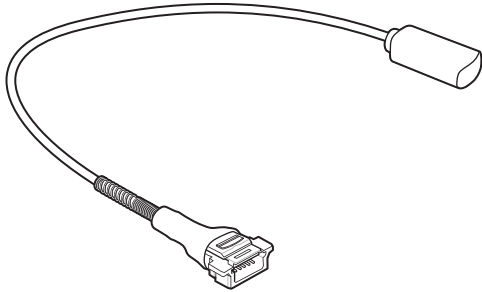
1. Press the release level toward the cable.
2. Rotate the adapter toward the front of the device and remove.

---

## Vibrator Cable

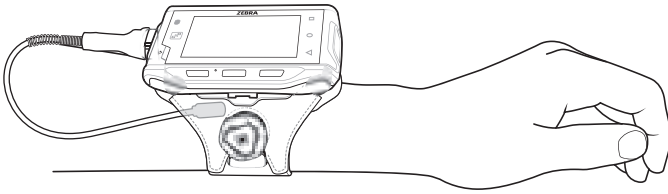
Use the Vibrator cable to provide a touch notification to a user to in noisy environments.

**Figure 123** Vibrator Cable



Connect the cable to the Interface connector on the WT6000.  
Slide the vibrator end between the Wrist Mount strap and arm.

**Figure 124** Connecting Vibrator Cable to WT6000



When an application generates a notification, the vibrator vibrates notifying the user.

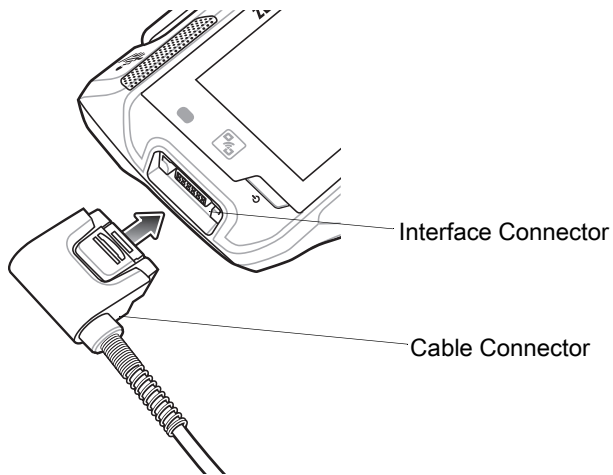
## RS4000 Scanner

To connect the RS4000 scanner to the WT6000:

- ✓ **NOTE:** There are two scanner configurations available. The short cable configuration connects the scanner to the WT6000 mounted on the arm. The extended cable configuration connects the scanner to the WT6000 mounted on the hip.

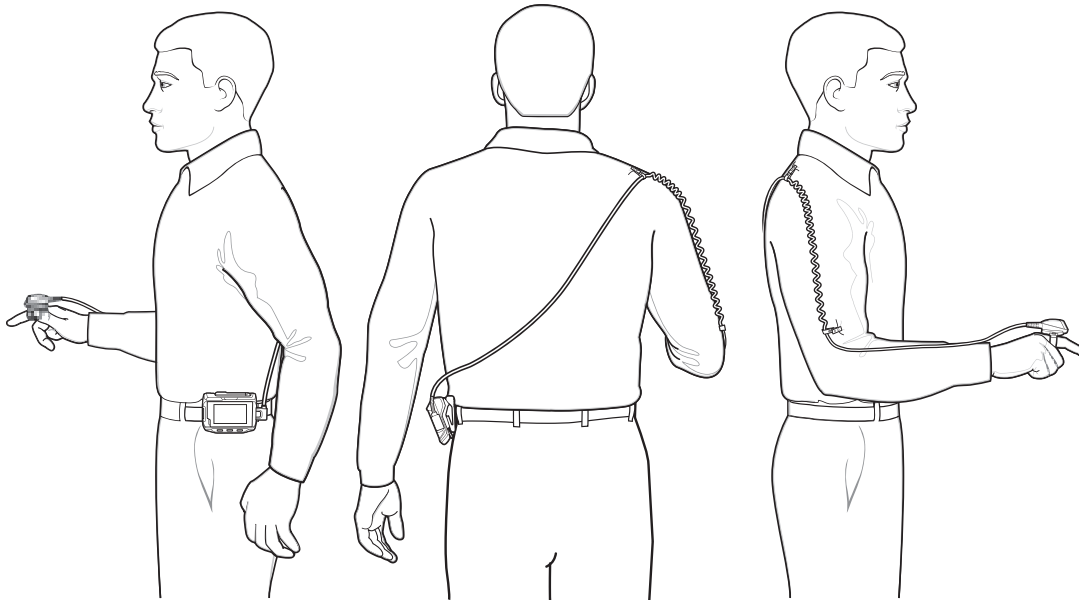
1. Connect the scanner interface cable to the WT6000 interface connector. If the WT6000 is mounted on the arm, connect the cable to the interface connector closest to the wrist.

**Figure 125** Connecting Scanner to WT6000



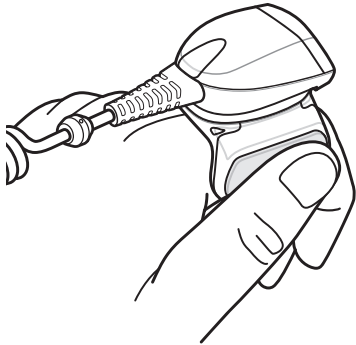
2. If using the extended cable configuration, route the scanner cable up to the shoulder and down to the hand that the scanner mounts on. Attach two cable clips to clothing and secure cable to cable clip.

**Figure 126** Cable Clip Installation



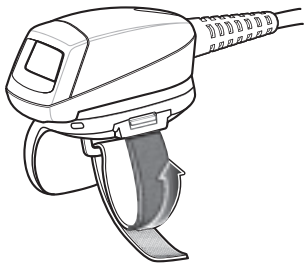
3. Rotate the trigger assembly to the correct position for the hand that the scanner mounts to.
4. Slide the scanner onto the index finger with the scan trigger next to the thumb.

**Figure 127** Place the Scanner on Index Finger



5. Tighten the finger strap.

**Figure 128** Tightening Straps



6. If required, cut excess finger strap material.

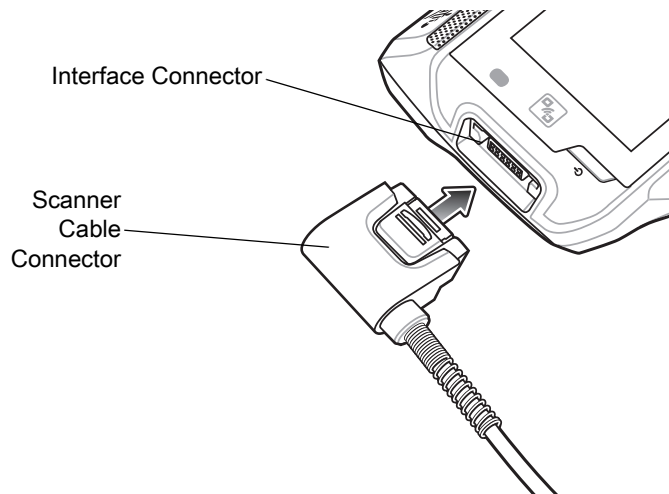
After connecting the scanner, warm boot the WT6000. See [Resetting the WT6000 on page 51](#) for information on performing a warm boot.

## RS5000 Imager

To connect the RS5000 imager to the wearable terminal:

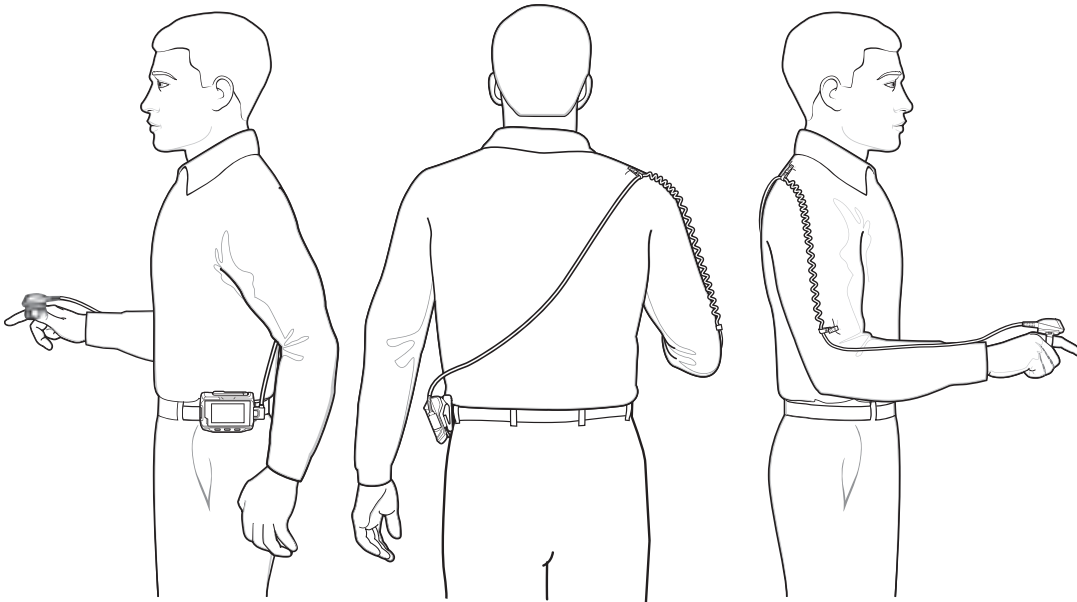
1. If using the WT6000 wearable terminal, remove the connector cap.
2. Connect the RS5000 interface cable to the wearable terminal interface connector. If connecting to a wrist mounted wearable terminal, connect to the interface connector closest to the wrist.

**Figure 129** Connect RS5000 to WT6000 Wearable Terminal



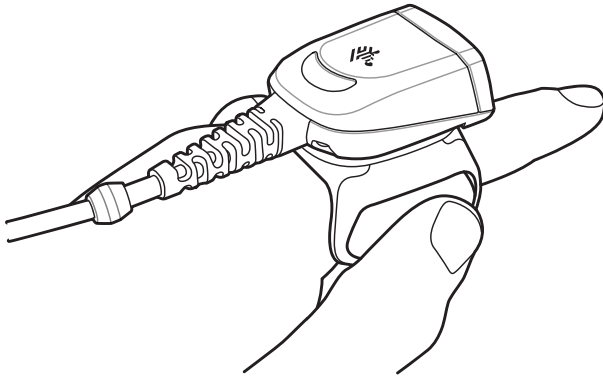
3. If using the extended cable configuration, route the scanner cable up to the shoulder and down to the hand that the scanner mounts on. Attach two cable clips to clothing and secure cable to cable clip.

**Figure 130** Cable Clip Installation



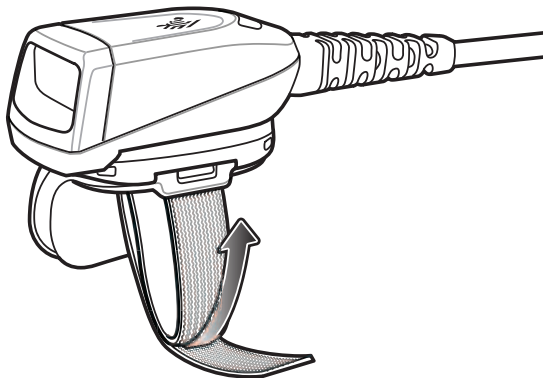
4. Rotate the trigger assembly to the correct position for the hand that the imager mounts to.
5. Slide the RS5000 onto the index finger with the scan trigger next to the thumb.

**Figure 131** Wearing the RS5000



6. Tighten the finger strap.

**Figure 132** Wearing the RS5000



7. If required, cut excess finger strap material.
8. Soft boot the wearable terminal. See [Resetting the WT6000 on page 51](#) for information on performing a soft boot.

# Maintenance and Troubleshooting

---

## Introduction

This chapter includes instructions on cleaning and storing the WT6000, battery maintenance and provides troubleshooting solutions for potential problems during WT6000 operations.

---

## Maintaining the WT6000

For trouble-free service, observe the following tips when using the WT6000:

- Protect the WT6000 from temperature extremes.
- Do not store or use the WT6000 in any location that is extremely dusty, damp, or wet.
- If the surface of the WT6000 screen becomes soiled, clean it with a soft cloth moistened with a diluted window-cleaning solution. Do not use bleach, ammonia or hydrogen peroxide products.
- Take care not to scratch the screen of the WT6000.
- The display of the WT6000 contains glass. Take care not to drop the WT6000 or subject it to strong impact.

---

## Battery Safety Guidelines

- The area in which the WT6000 units are charged should be clear of debris and combustible materials or chemicals. Particular care should be taken where the device is charged in a non-commercial environment.
- Do not use incompatible batteries and chargers. If you have any questions about the compatibility of a battery or a charger, contact Zebra Support. See [Service Information on page 13](#) for contact information.
- Do not crush, puncture, or place a high degree of pressure on the battery.
- Follow battery usage, storage, and charging guidelines.
- Improper battery use may result in a fire, explosion, or other hazard.
- To charge the mobile device battery, the battery and charger temperatures must be between +32°F and +104°F (0°C and +40°C)
- Do not disassemble or open, crush, bend or deform, puncture, or shred.
- Severe impact from dropping any battery-operated device on a hard surface could cause the battery to overheat.
- Do not short circuit a battery or allow metallic or conductive objects to contact the battery terminals.

- Do not modify or remanufacture, attempt to insert foreign objects into the battery, immerse or expose to water or other liquids, or expose to fire, explosion, or other hazard.
- Do not leave or store the equipment in or near areas that might get very hot, such as in a parked vehicle or near a radiator or other heat source. Do not place battery into a microwave oven or dryer.
- Battery usage by children should be supervised.
- Please follow local regulations to promptly dispose of used re-chargeable batteries.
- Do not dispose of batteries in fire.
- Seek medical advice immediately if a battery has been swallowed.
- In the event of a battery leak, do not allow the liquid to come in contact with the skin or eyes. If contact has been made, wash the affected area with large amounts of water and seek medical advice.
- If you suspect damage to your equipment or battery, call Customer Support to arrange for inspection. See [Service Information on page 13](#) for contact information.

---

## Long Term Storage

When storing the WT6000 for a long period of time, it is recommended to remove the battery. When returning the WT6000 to everyday operation, install a fully charged battery.

---

## Cleaning Instructions



**CAUTION:** Always wear eye protection.

Read warning label on compressed air and alcohol product before using.

If you have to use any other solution for medical reasons please contact Zebra for more information.



**WARNING:** Avoid exposing this product to contact with hot oil or other flammable liquids. If such exposure occurs, unplug the device and clean the product immediately in accordance with these guidelines.

## Approved Cleanser Active Ingredients

100% of the active ingredients in any cleaner must consist of one or some combination of the following: isopropyl alcohol, or mild dish soap.

## Harmful Ingredients

The following chemicals are known to damage the plastics on the device and should not come in contact with the device: ammonia solutions, compounds of amines or ammonia; acetone; ketones; ethers; aromatic and chlorinated hydrocarbons; aqueous or alcoholic alkaline solutions; ethanolamine; toluene; trichloroethylene; benzene; carbolic acid, TB-lysoform, bleach products and hydrogen peroxide.

## Cleaning Instructions

Do not apply liquid directly to the device. Dampen a soft cloth or use pre-moistened wipes. Do not wrap the device in the cloth or wipe, but gently wipe the unit. Be careful not to let liquid pool around the display window or other places. Allow the unit to air dry before use.



### Special Cleaning Notes

Many vinyl gloves contain phthalate additives, which are often not recommended for medical use and are known to be harmful to the housing of the device. The device should not be handled while wearing vinyl gloves containing phthalates, or before hands are washed to remove contaminant residue after gloves are removed. If products containing any of the harmful ingredients listed above are used prior to handling the device, such as hand sanitizer that contain ethanolamine, hands must be completely dry before handling the device to prevent damage to the plastics.

### Cleaning Materials Required

- Alcohol wipes
- Lens tissue
- Cotton tipped applicators
- Isopropyl alcohol
- Can of compressed air with a tube.

### Cleaning Frequency

The cleaning frequency is up to the customer's discretion due to the varied environments in which the WT6000 units are used. They may be cleaned as frequently as required. However when used in dirty environments it may be advisable to periodically clean the scanner exit window to ensure optimum scanning performance.

### Cleaning the WT6000

#### Housing

Using the alcohol wipes, wipe the housing.

#### Display

The display can be wiped down with the alcohol wipes, but care should be taken not to allow any pooling of liquid around the edges of the display. Immediately dried the display with a soft, non-abrasive cloth to prevent streaking.

#### Power Connector

1. Remove the battery from WT6000.
2. Dip the cotton portion of the cotton tipped applicator in isopropyl alcohol.
3. Rub the cotton portion of the cotton tipped applicator back-and-forth across the connector inside the handle of the WT6000. Do not leave any cotton residue on the connector.
4. Repeat at least three times.
5. Use the cotton tipped applicator dipped in alcohol to remove any grease and dirt near the connector area.
6. Use a dry cotton tipped applicator and repeat steps 3 through 5.
7. Spray compressed air on the connector area by pointing the tube/nozzle about ½ inch away from the surface.



**CAUTION:** Do not point nozzle at yourself and others, ensure the nozzle or tube is away from your face.

8. Inspect the area for any grease or dirt, repeat if required.

## Cleaning Cradle Connectors

Use this procedure to clean the connectors on a cradle:

1. Remove power from the cradle.
2. Dip the cotton portion of the cotton tipped applicator in isopropyl alcohol.
3. Rub the cotton portion of the cotton tipped applicator along the pins of the connector. Slowly move the applicator back-and-forth from one side of the connector to the other. Do not let any cotton residue on the connector.
4. All sides of the connector should also be rubbed with the cotton tipped applicator.
5. Spray compressed air in the connector area by pointing the tube/nozzle about ½ inch away from the surface.



**CAUTION:** Do not point nozzle at yourself and others, ensure the nozzle or tube is pointed away from your face.

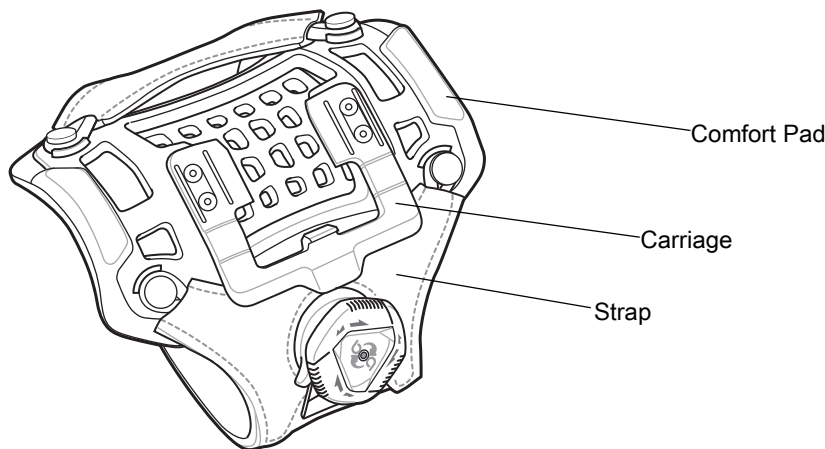
6. Ensure that there is no lint left by the cotton tipped applicator, remove lint if found.
7. If grease and other dirt can be found on other areas of the cradle, use lint free cloth and alcohol to remove.
8. Allow at least 10 to 30 minutes (depending on ambient temperature and humidity) for the alcohol to air dry before applying power to cradle.

If the temperature is low and humidity is high, longer drying time is required. Warm temperature and dry humidity requires less drying time.

## Cleaning the Wrist Mount

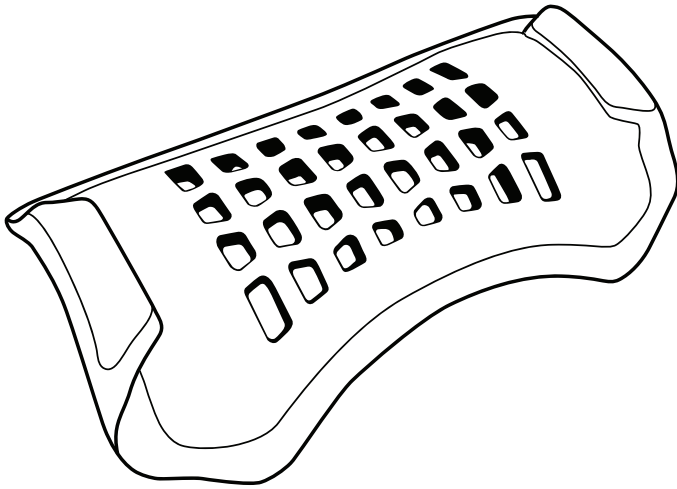
It may be necessary to wash the wrist mount strap and replaceable comfort pad when they become soiled.

**Figure 133** Wrist Mount

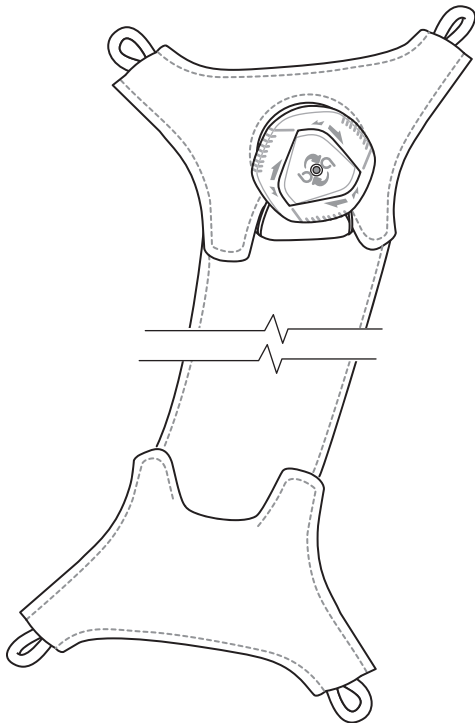


Remove the strap and comfort pad from the wrist mount. Hand wash in cold water with a mild detergent (such as Woolite®). Do not use bleach. Air dry. Do not use a dryer.

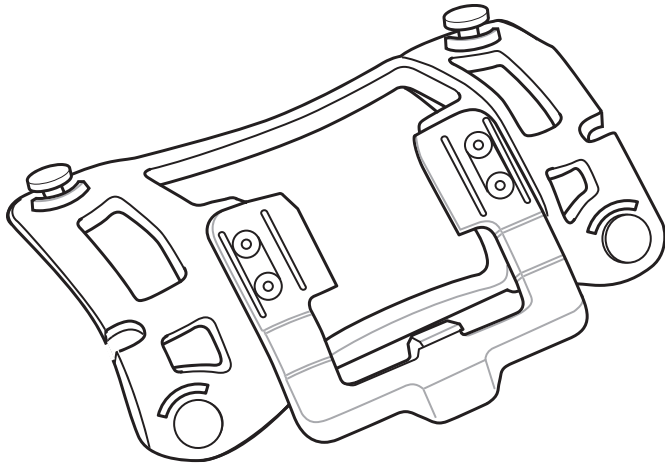
**Figure 134** Comfort Pad



**Figure 135** Strap



**Figure 136** Carriage



## Troubleshooting

### WT6000

**Table 17** Troubleshooting the WT6000

Problem	Cause	Solution
WT6000 does not turn on.	Battery not charged.	Charge or replace the battery in the WT6000.
	Battery not installed properly.	Ensure battery is installed properly. See <a href="#">Installing the Battery on page 16</a> .
	System crash.	Perform a soft reset. If the WT6000 still does not turn on, perform a hard reset. See <a href="#">Resetting the WT6000 on page 51</a> .
Battery did not charge.	Battery failed.	Replace battery. If the WT6000 still does not operate, try a soft reset, then a hard reset. See <a href="#">Resetting the WT6000 on page 51</a> .
	WT6000 removed from cradle before charging completed.	Insert the WT6000 into the cradle and begin charging. The battery fully charges in less than four hours.
	Ambient temperature of the cradle is too warm or too cold.	The ambient temperature must be between 0°C and 40°C (32°F and 104°F).
During data communication, no data was transmitted, or transmitted data was incomplete.	WT6000 unplugged from host computer during communication.	Reconnect the programming cable to the host computer and re-transmit.
	Communication software was incorrectly installed or configured.	See system administrator.
WT6000 turns itself off.	WT6000 is inactive.	The WT6000 turns off after a period of inactivity. If the WT6000 is running on battery power, this period can be set to 15 seconds, 30 seconds, 1 minute, 2 minutes, 5 minutes, 10 minutes, or 30 minutes.  Change the setting if you need a longer delay before the automatic shutoff feature activates.
	Battery is depleted.	Place the WT6000 in the cradle to re-charge the battery.
	The WT6000's battery is low and it powers down to protect memory content.	Place the WT6000 in the cradle to re-charge the battery.

**Table 17** Troubleshooting the WT6000 (Continued)

Problem	Cause	Solution
A message appears stating that the WT6000 memory is full.	Too many files stored on the WT6000.	Delete unused memos and records. You can save these records on the host computer.
	Too many applications installed on the WT6000.	If you have installed additional applications on the WT6000, remove them to recover memory.
The WT6000 does not accept scan input.	Unreadable bar code.	Ensure the symbol is not defaced.
	Distance between scanner exit window and bar code is incorrect.	Move the WT6000 closer or further from the bar code to the proper scanning range.
	WT6000 is not programmed for the bar code.	Verify that the WT6000 can read the type of bar code being scanned (See <a href="#">Technical Specifications</a> ). Ensure that the bar code parameters are set properly for the bar code being scanned.
	WT6000 is not programmed to generate a beep.	Verify that a beep on a good decode is used.
During USB data communications, no data was transmitted, or transmitted data was incomplete.	Incorrect cable connection.	See <a href="#">Accessories</a> .
	Communications software is not installed or configured properly.	Perform setup as described in <a href="#">Accessories</a> .

# Specifications

## Technical Specifications

The following tables summarize the WT6000's intended operating environment and general technical hardware specifications.

**Table 18** Technical Specifications

Item	Description
<b>Physical and Environmental Characteristics</b>	
Dimensions (H x L x W)	121 mm (4.8 in.) x 89mm (3.5 in.) x 34 mm (1.3 in.)
Weight	245 g (8.7 oz.)
Display	Color Transflective LCD Display and IPS Technology, 3.2 in. diagonal, WVGA (800 x 480 pixels), 24 bits (16 million pixels), 400+ Nits
Touch Panel	Multi-Touch projected capacitive; fingertip (bare or gloved) input; capacitive stylus supported (sold separately); Corning® Gorilla® Glass
Backlight	Configurable LED backlight control
Battery	PowerPrecision+ rechargeable 3.7 VDC 3,350 mAh Lithium-Ion battery. PowerPrecision+ rechargeable 3.7 VDC 5,000 mAh Lithium-Ion battery.
Backup Power	SuperCap technology
Notification	Vibration, Audible tone, Multi - color LEDs
Voice and Audio	Integrated Speaker, Mono wired headsets with a microphone and push-to-talk button and Bluetooth wireless headset support.
<b>Performance Characteristics</b>	
CPU	Quad-Core 1.0 GHz processor
Operating System	Android AOSP 7.1.1 (Nougat) with Mobility Extensions (Mx), for true enterprise class operating system.
Memory	1 GB RAM, 4 GB Flash (pSLC)
Application Development	Zebra Android EMDK

**Table 18** Technical Specifications (Continued)

Item	Description
<b>User Environment</b>	
Operating Temperature	-30°C to 50°C (-22°F to 122°F)
Storage Temperature	-40°C to 70°C (-40°F to 158°F)
Battery Charging Temperature	0°C to +40°C (32°F to 104°F) ambient temperature range.
Humidity	5% - 95% non-condensing
Drop Specification	1.2 m (4 ft.) drop to concrete (36 drops, over temperature range)
Tumble	1,000 tumbles @ 0.5 m (1.6 ft.) (room temperature)
Vibration	Sine 5-2000 Hz, 4g peak, 1 hour per axis Random 20-2000 Hz, 6g RMS or 0.04g2/Hz, 1 hour per axis
ESD	± 20k VDC air discharge ± 10k VDC contact discharge ± 10k VDC indirect discharge
<b>Wireless LAN Data Communications</b>	
Radio	IEEE ® 802.11a/b/g/n/ac
Data Rates	5 GHz: 802.11a/n - up to 135 Mbps; 802.11ac - Single-stream and dual-stream solution with data rates up to 433.3 and 866.7 Mbps 2.4 GHz: 802.11b/g/n - up to 72.2 Mbps (one stream) 144.4 Mbps (dual stream)
Operating Channels	Channels 36 - 165 (5180 - 5835 MHz) Channels 1 - 13 (2412 - 2472 MHz) Actual operating channels/frequencies depend on regulatory rules and certification agency
Security and Encryption	WEP, WPA - TKIP, WPA2- TKIP, WPA2-AES EAP-TTLS/PAP, EAP-TTLS/MSCHAPv2, PEAPv0/EAP-MSCHAPv2, PEAPv1/EAP-GTC, TTLS-MSCHAP, EAP-TLS, EAP-FAST (MSCHAPv2 and GTC), LEAP VPN functionality (L2TP, PPTP and IPSec)
Multimedia	Wi-Fi Multimedia™ (WMM)
Certifications	802.11n, 802.11ac, CCXv4, Wi-Fi Direct
Fast Roam	PMKID Caching, Opportunistic Key Caching (OKC), Cisco CCKM, 802.11r.
<b>Wireless PAN Data Communications</b>	
Bluetooth	Bluetooth 4.1 (Bluetooth Smart Technology)
<b>Data Capture</b>	
Laser Scanning	Optional RS4000 laser scanner.



**Table 18** Technical Specifications (Continued)

Item	Description
Imager	Optional RS507, RS5,000 and RS6000 ring scanners.
NFC	Multi-Protocol NFC.

# Index

## Numerics

- 1-D bar codes ..... 54
- 2-D bar codes ..... 54

## A

- accessories ..... 95
- airplane mode ..... 24
- albums ..... 80
- android version ..... 10
- application shortcuts ..... 36

## B

- bar codes
  - one dimensional ..... 54
  - two dimensional ..... 54
- battery charging temperature ..... 144
- battery usage ..... 23
- browser ..... 46
- build number ..... 10
- bullets ..... 12

## C

- calculator ..... 46
- calendar ..... 46
- characters, special ..... 42
- clock ..... 46
- configuration ..... 11
- contacts ..... 46
- conventions
  - notational ..... 12
- CPU ..... 143

## D

- data capture
  - imager operational modes
    - decode mode ..... 55
    - pick list mode ..... 55

- imaging ..... 54
- laser scanning ..... 54
- one dimensional bar codes ..... 54
- scan angle ..... 55
- scan range ..... 55
- scanning ..... 54
- two dimensional bar codes ..... 54
- datawedge ..... 46
- dimensions ..... 143
- display ..... 11, 143
- downloads ..... 46
- drop specification ..... 144
- DWDEmo ..... 46

## E

- EAP ..... 65
- email ..... 47

## F

- file browser ..... 47, 78
- file transfer ..... 52

## G

- gallery ..... 80

## H

- humidity ..... 144

## I

- imager. *See* data capture, imaging
- imaging ..... 54
- information, service ..... 13

## L

- laser scanning

<i>See data capture</i> .....	54
LEDs	
scan and decode .....	56
lithium-ion battery .....	14
low battery notification .....	23

## M

maintenance .....	135
memory .....	143
mobile computer	
starting .....	18
model number .....	10

## O

operating system .....	143
operating temperature .....	144

## P

PEAP-GTC .....	65
PEAP-MSCHAPv2 .....	65
photo transfer .....	52
PTT Express .....	47

## R

RS5000 scanning .....	56
RS507 scanning .....	59
RS6000 scanning .....	57

## S

scanning	
bar codes .....	54
imaging .....	54
RS5000 .....	56
RS507 .....	59
RS6000 .....	57
<i>See data capture</i> .....	54
screen	
Zebra splash screen .....	18
serial number .....	10
service information .....	13
set date .....	24
set time .....	24
set time zone .....	24
settings .....	47
sound recorder .....	47
special characters .....	42
starting the mobile computer .....	18
storage temperature .....	144

## T

TLS .....	65
transferring files using USB .....	52
troubleshooting .....	141
TTLS	
TTLS-MSCHAP .....	65
TTLS-MSCHAPv2 .....	65
TTLS-PAP .....	65

## U

unpacking .....	14
USB .....	52

## W

weight .....	143
WEP .....	65
WLAN radio .....	144
WPA .....	65

