

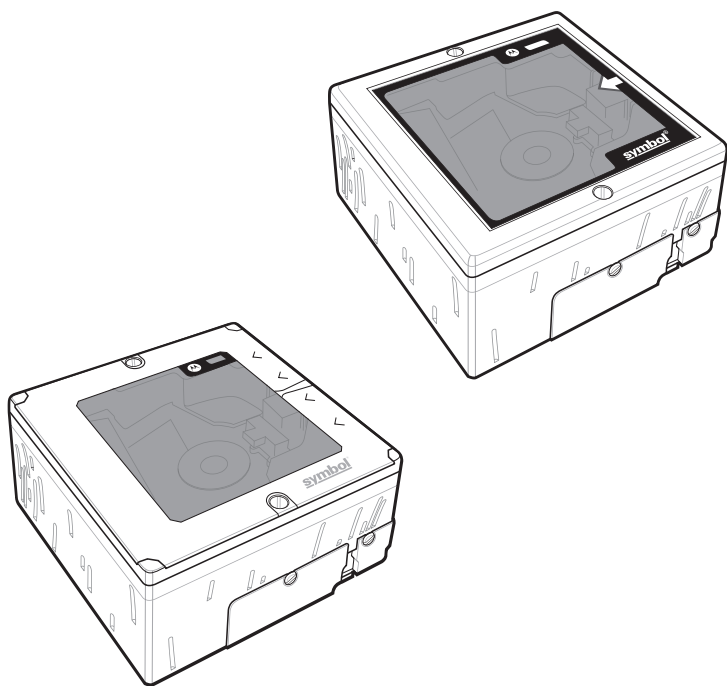

Symbol LS7808 Horizontal Slot Scanner

Quick Reference Guide



© 2007-2010 MOTOROLA, INC. All rights reserved.

Motorola reserves the right to make changes to any product to improve reliability, function, or design.

Motorola does not assume any product liability arising out of, or in connection with, the application or use of any product, circuit, or application described herein.

No license is granted, either expressly or by implication, estoppel, or otherwise under any patent right or patent, covering or relating to any combination, system, apparatus, machine, material, method, or process in which Motorola products might be used. An implied license exists only for equipment, circuits, and subsystems contained in Motorola products.

MOTOROLA, the Stylized M Logo and Symbol and the Symbol logo are registered trademarks of Motorola, Inc. Other product names mentioned in this manual may be trademarks or registered trademarks of their respective companies and are hereby acknowledged.

Motorola, Inc.

One Motorola Plaza

Holtsville, N.Y. 11742-1300

<http://www.motorola.com/enterprisemobility>

Warranty

For the complete Motorola hardware product warranty statement, go to:

<http://www.motorola.com/enterprisemobility/warranty>

Introduction

This guide is designed to assist during routine LS7808 operation. Detailed information about unpacking, installation, performance specifications, programming and troubleshooting can be found in the *LS7808 Product Reference Guide* (p/n 72E-73952-XX).

Product Description

The Symbol LS7808 horizontal slot scanner is a high performance, omni-directional scanner that supports high throughput applications at the point of sale (POS). The scanner reads all retail symbologies and has multi-interface capability to interface to all popular POS devices. The scanner is designed for horizontal in-counter mounting and allows slide-through scanning of items enhancing productivity and throughput. The scanner has an integrated Electronic Article Surveillance (EAS) antenna for use with Checkpoint® EAS systems.

The LS7808-SR20007TCR features standard tin oxide glass, and the LS7808-SR2X009SCR features scratch proof sapphire glass.

Configurations

The Symbol LS7808 is available in the following configurations.

| Configuration | Features |
|--------------------------|------------------------------------------------------------------------------------------------------------------------------------------------------------|
| Symbol LS7808-SR20007TCR | Standard (tin oxide) glass window; twilight black; Checkpoint® EAS; RoHS compliant. |
| Symbol LS7808-SR20009SCR | Scratch proof (sapphire) glass window; stainless steel bezel top; Checkpoint® EAS; RoHS compliant. |
| Symbol LS7808-SR22009SCR | Scratch proof (sapphire) glass window; stainless steel bezel top; Checkpoint® EAS; RoHS compliant; Remote Scanner Management (RSM) ready "out of the box." |

A stainless steel in-counter mounting kit (p/n 12-17206-02R) is required for all models. See the *Mounting Instructions and EAS Installation Guide* for mounting/installation instructions.

Operating the Scanner

Parts

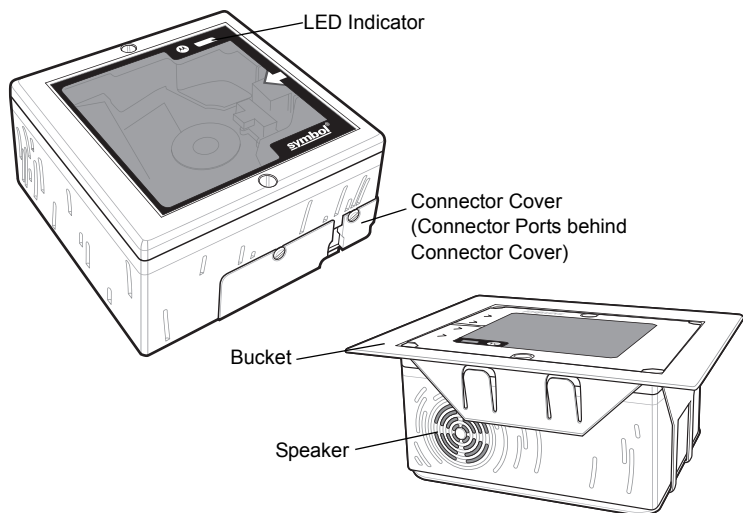

Power

The LS7808 does not have an on/off switch. It is ready to scan when connected to a power supply.

Indicator Lights

The scanner employs an LED with a combination of red and green lights to indicate operation and decode status. See [LED Definitions on page 10](#) for the different light combinations and their meanings.

If the scanner is not operating normally, contact the technical person in charge of scanning, or call Motorola Enterprise Mobility Support (see details on the back cover).

Sleep Mode

The scanner automatically enters Sleep mode when it has been inactive for a specified length of time. The scanner has two levels of sleep: laser and motor. In laser sleep mode, after ten seconds of inactivity the laser pulses at a 50% rate, and then drops to 3% after a specified time. In motor sleep mode, the scanner is programmed to turn off the motor and the laser.

To wake the scanner from sleep mode, present a bar code at the scanner window.

Beeper Volume

The scanner emits a short beep when it successfully reads a bar code. The volume of the beep is changed electronically by a command sent by the host, or by scanning one of the beeper volume bar codes in the LS7808 Product Reference Guide. See [Beeper Definitions on page 8](#).

Connections

The scanner's ports are at the lower edge of the scanner. Remove the connection cover to access the ports.

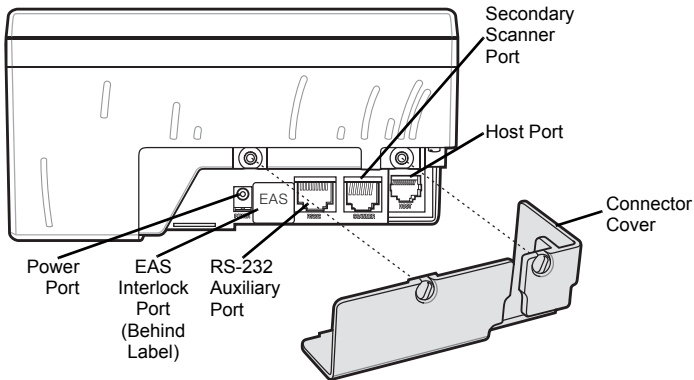

Routing the Cables

The scanner case has several channels to route the outgoing cables so that they are organized and don't hinder the scanner's placement. After placing the cable connectors in the appropriate scanner ports, route the cables through the nearest channel.

For a cable with a Y-connector (containing both power and interface connectors):

1. Connect the power and interface cables to the appropriate ports.
2. Route the cables according to the following diagram.

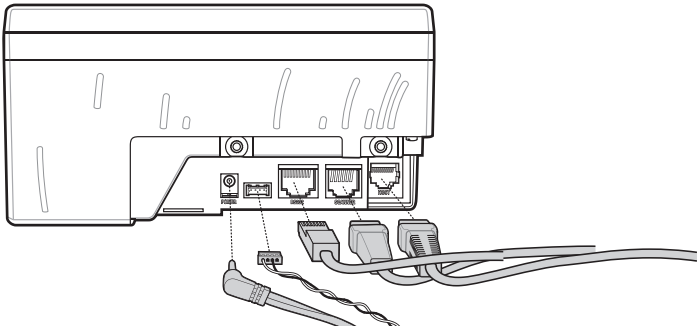

Installing the Scanner

The LS7808 mounts in the counter with the face of the scanner flush with the counter top. Refer to the *LS7808 Product Reference Guide* for detailed installation instructions.

Scanning Bar Codes

Install and program the scanner. Refer to the *LS7808 Product Reference Guide* for programming instructions. For assistance, contact the local supplier or Motorola Enterprise Mobility Support (see details on the back cover).

To scan a bar code:

1. Ensure all cable connections are secure.
2. Orient the item with the bar code facing the scanner window.
3. Move the item through the active scan area (see [page 8](#)) in the direction of the scan arrow, or place the item in front of the scanner.

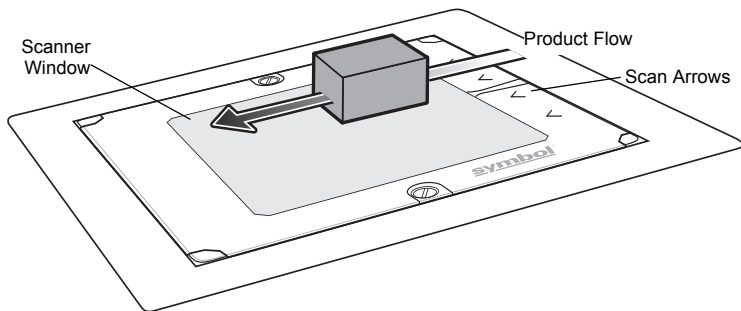

4. Upon successful decode, the scanner beeps and the green LED flashes momentarily.

Active Scan Area

The active scan area, in front of the scanner window, is optimized to scan items as they move in the direction of the scan arrow.

The dotted areas below represent the active scan area.

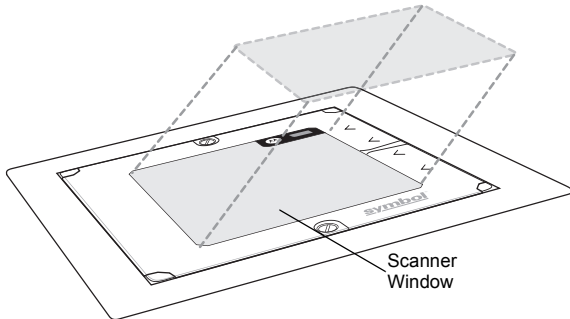

Beeper Definitions

The scanner communicates with the user by emitting different beeper sequences and patterns. See the Beeper Indications table below for beeper sequences that occur during both normal scanning and while programming the scanner.

| Beeper Sequence | Indication |
|--------------------------|----------------------------------------------------------------------------------------------------------------------------------------------------------|
| Standard Use | |
| 3 high beeps | Power up. |
| High beep | A bar code symbol was decoded (if decode beeper is enabled). |
| 4 long low beeps | A transmission error was detected in a scanned symbol. The data is ignored. This occurs if the scanner is not properly configured. Check option setting. |
| 5 low beeps | Conversion or format error. |
| High-high-high-low beeps | RS-232 receive error on RS-232 host or RS-232 auxiliary port. |

| Beeper Sequence | Indication |
|-----------------------------------------------------------------|-----------------------------------------------------------------------------------------------------------------------------------------------------------------------|
| Code 39 Buffering | |
| High-low beep | New Code 39 data was entered into the buffer. |
| 3 long high beeps | Code 39 buffer is full. |
| Low-high-low beeps | The Code 39 buffer was erased or there was an attempt to clear or transmit an empty buffer. |
| Low-high beeps | A successful transmission of buffered data. |
| Host Specific | |
| USB only | |
| 4 short high beeps | Scanner has not completed initialization. Wait several seconds and scan again. |
| Scanner gives a power-up beep after scanning a USB Device Type. | Communication with the bus must be established before the scanner can operate at the highest power level. |
| This power-up beep occurs more than once. | The USB bus may put the scanner in a state where power to the scanner is cycled on and off more than once. This is normal and usually happens when the PC cold boots. |
| RS-232 Host only | |
| High beep | A <BEL> character is received and Beep on <BEL> is enabled. |
| RS-232 Auxiliary Port only | |
| High beep | A complete block of data was received and sent to the host, either due to a carriage return or because the two-second serial response timeout has elapsed. |
| 4 long low beeps | A data overrun condition has occurred. Abstain from scanning data from other ports when large amounts of data are sent to the RS-232 Auxiliary port. |

LED Definitions

In addition to beeper sequences, the scanner communicates with the user via an LED display. The Standard LED Definitions table defines LED indications that display during scanning.

| LED | Indication |
|----------------------------------------|-----------------------------------------------------------------------------|
| Off | No power is applied to the scanner. |
| Green | The scanner is on and ready to scan. |
| Momentary flash | A bar code was successfully decoded. |
| Slow continuous red flashing, green on | The scanner is in programming mode. |
| Fast continuous red flashing, green on | There is an internal problem; the laser is shut off for regulatory reasons. |
| Green on (and laser blinking) | Scanner is in low power blink mode. |
| Red and green on | Scanner is in low power (sleep) mode and laser shutdown mode. |

Maintenance

Cleaning the exit window is the only maintenance required. A dirty or scratched window may affect scanning activity.

- Remove any dirt particles with a damp cloth.
- Wipe the window with a tissue moistened with ammonia or water.

To clean the exit window:

1. Insert a coin into the large screw heads on the front of the scanner and turn counter-clockwise.
2. Lift off the window.
3. Wipe clean the underside of the upper window.
4. Wipe clean the top surface of the lower window.
5. Re-install the top cover by tightening the two large screws.

To change the exit window:

1. Remove the window as described above.
2. Replace with a new window.
3. Reinstall the top cover by tightening the two large screws.

Troubleshooting

| Problem | Possible Causes | Possible Solutions |
|-----------------------------------------------------------------------------------------------------------|------------------------------------------------------------------|----------------------------------------------------------------------------------------------------------------------------------------------------------------------------------------------------------------------------------------------|
| The omni-line scan pattern does not display when you follow the directions for installing the host cable. | No power to the scanner. | Ensure the host has power, and is on. If the scanner uses a separate power supply, ensure it's connected to a working AC outlet. Power-up sequence is incorrect. Refer to the <i>LS7808 Product Reference Guide</i> for more information. |
| | Interface cable is not properly connected. | Check for loose cable connections. |
| Scan line(s) display, but bar code cannot be read. | Scanner is not programmed to read the bar code type. | Ensure scanner is programmed to read the bar code type you are scanning. |
| | Bar code is damaged. | Try scanning other bar codes of the same bar code type. |
| | Bar code is too far from scanner. | Move the bar code closer to the scanner. |
| | The host has disabled scanning or overridden parameter settings. | See the technical person in charge of scanning. |
| Bar code is decoded, but not transmitted to the host. | Scanner is not programmed for the correct host type. | Scan the appropriate host type bar code. |

| Problem | Possible Causes | Possible Solutions |
|---------------------------------------------------------------------------------------------------------|---------------------------------------------------------------------------------------------------------|----------------------------------------------------------------------------------------------------------------------------------------------------------------------------------------------------------------------------------------------------------------------------------------------------------------------------------------------------|
| Scanned data is incorrectly displayed on the host. | Scanner is not programmed to work with the host. Check scanner host type parameters or editing options. | <p>Ensure proper host is selected.</p> <p>For RS-232, ensure the scanner's communication parameters match the host's settings.</p> <p>For keyboard wedge, ensure scanner is programmed with the correct country code and that the CAPS LOCK key is off.</p> <p>Ensure editing options (e.g., UPCE-to-UPCA Conversion) are properly programmed.</p> |
| Although the green and red LEDs are on, the scanner does not produce the omni-directional scan pattern. | The scanner has gone into the low power "Motor Sleep" mode. | Move a bar coded item over the active scan area to awaken the unit. |
| USB or Synapse host not functioning properly. | Scanner does not recognize host. | Remove and reinsert external power supply to force cable to autodetect correct host. |

 **NOTE** If the symbol still does not scan, contact distributor or call Motorola Enterprise Mobility Support. See the back cover for contact information.

Programming

Generally, the technical person in charge of scanning customizes the scanner for the particular application using programming bar codes found in the *LS7808 Product Reference Guide*, p/n 72E-73952-XX. If the user is programming the scanner, consult the *LS7808 Product Reference Guide* for more information.

Following are some frequently used programming bar codes.

✓ **NOTE** For additional host types, refer to the LS7808 Product Reference Guide available at <http://www.motorola.com/enterprisemobility/manuals>.

When scanning the desired bar code, cover the other bar code on the page.

Test

To confirm that your scanner is working properly, scan the UPC-A bar code below.

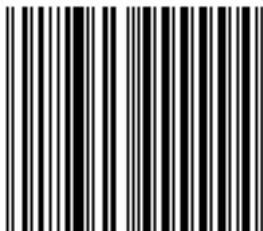

Verify the Scanner Is Working

Set Defaults

✓ **NOTE** When scanning the desired bar code, cover other bar code on page.

Scanning this bar code sets all parameters to their factory default values.

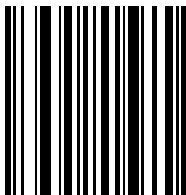

Set Defaults

Host Type Selection

If a Synapse cable (i.e., part number STlxx-xxxx) is used, the scanner autocoders the type of host, so there is no need to scan host type selection bar codes.

If a USB interface is used, the scanner autocoders the USB and defaults to the HID keyboard interface. See [page 27](#) to select the IBM Hand-Held host type. Refer to the *LS7808 Product Reference Guide*, p/n 72-69531-XX, for additional USB host types.

If a Keyboard Wedge, RS-232, Wand Emulation or IBM 46XX host is used, select that host type from the programming bar codes that follow. If Keyboard Wedge is selected, also select a country keyboard type from the following pages.

Keyboard Wedge Host Type

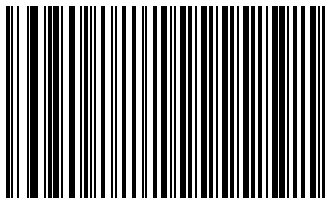

IBM PC/AT & IBM PC Compatibles

Keyboard Wedge Host Type (continued)



NOTE When scanning the desired bar code, cover other bar code on page.

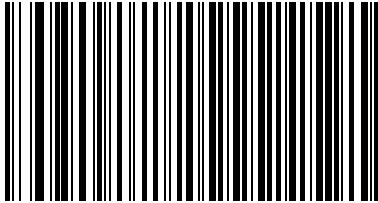

IBM PS/2 (Model 30)

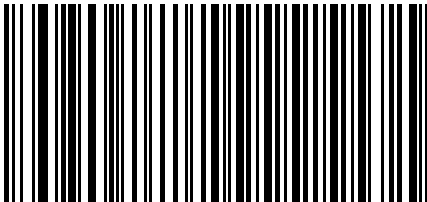

IBM AT NOTEBOOK

Keyboard Wedge Host Type (continued)

✓ **NOTE** When scanning the desired bar code, cover other bar code on page.

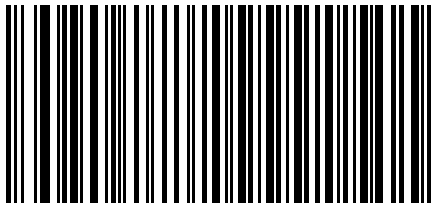
**NCR7 7052****Country Keyboard Types (Country Codes)**

Country keyboard options apply to the Keyboard Wedge interface only.

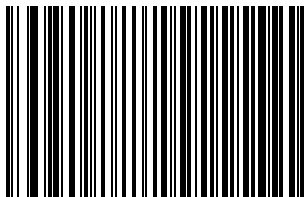
**North American**

Country Keyboard Types (continued)

✓ **NOTE** When scanning the desired bar code, cover other bar code on page.

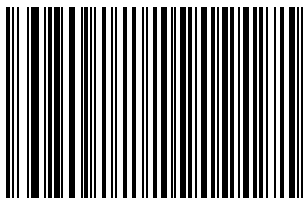
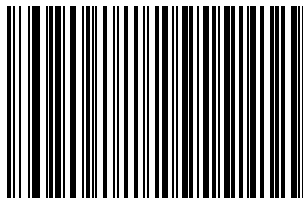
**French****French Canadian Win95/98**

Country Keyboard Types (continued)

NOTE When scanning the desired bar code, cover other bar code on page.



French Canadian XP/2000

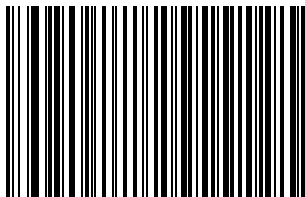

German

Country Keyboard Types (continued)

✓ **NOTE** When scanning the desired bar code, cover other bar code on page.

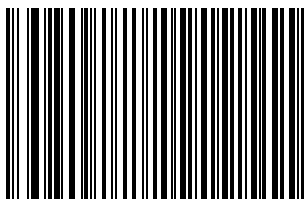

Spanish

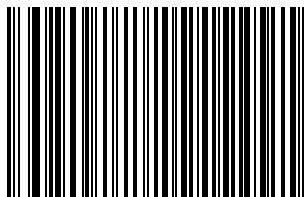

Italian

Country Keyboard Types (continued)

NOTE When scanning the desired bar code, cover other bar code on page.

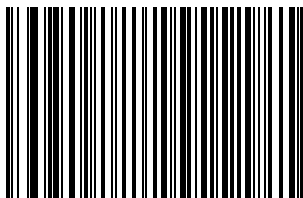

Swedish

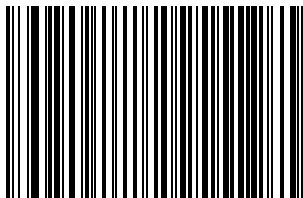

UK English

Country Keyboard Types (continued)

✓ **NOTE** When scanning the desired bar code, cover other bar code on page.

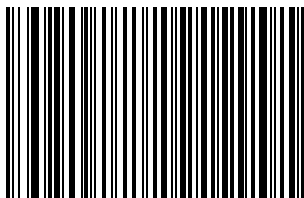

Japanese

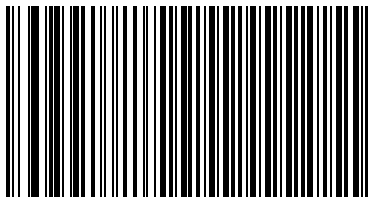
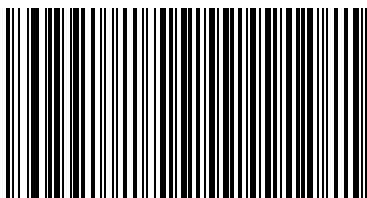

Brazil Portuguese Windows

RS-232 Host Types**Standard RS-232****ICL RS-232**

RS-232 Host Types (continued)

- ✓ **NOTE** When scanning the desired bar code, cover other bar code on page.

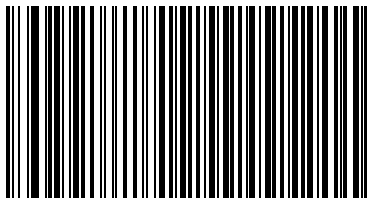
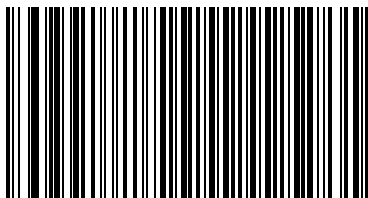
**Wincor-Nixdorf RS-232 Mode A****Wincor-Nixdorf RS-232 Mode B**

RS-232 Host Types (continued)

- ✓ **NOTE** When scanning the desired bar code, cover other bar code on page.

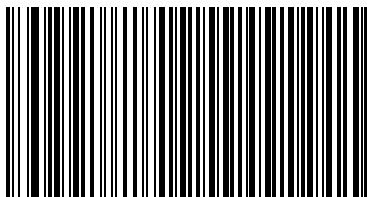
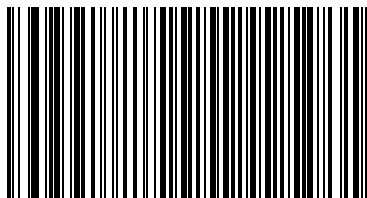
**Fujitsu RS-232****OPOS**

RS-232 Host Types (continued)

- ✓ **NOTE** When scanning the desired bar code, cover other bar code on page.

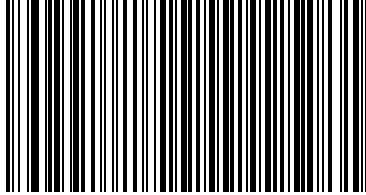
**JPOS****USB Host Types**

- ✓ **NOTE** When scanning the desired bar code, cover other bar code on page.

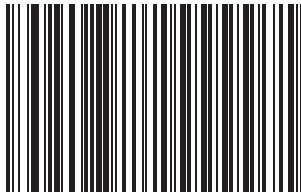
**HID Keyboard Emulation
(Common Keyboard Wedge Interfacing)**

USB Host Types (continued)

NOTE When scanning the desired bar code, cover other bar code on page.

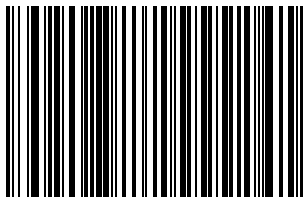

IBM Table Top USB

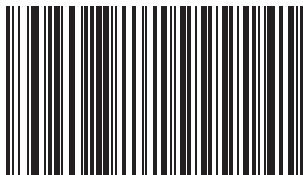

**IBM Hand-Held USB
(For IBM SurePOS 700 Series)**

USB Host Types (continued)



NOTE When scanning the desired bar code, cover other bar code on page.



OPOS

IBM 46XX Host Types

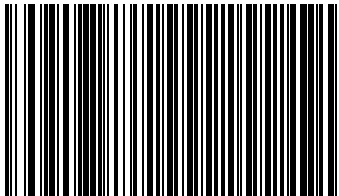

*

None Selected

IBM 46XX Host Types (continued)**NOTE**

When scanning the desired bar code, cover other bar code on page.

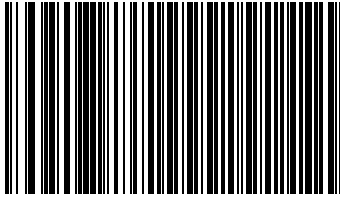
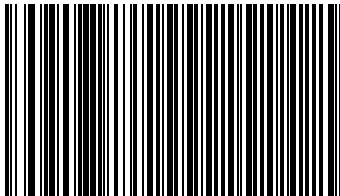
**Port 5B****Port 9B**

IBM 46XX Host Types (continued)



NOTE When scanning the desired bar code, cover other bar code on page.

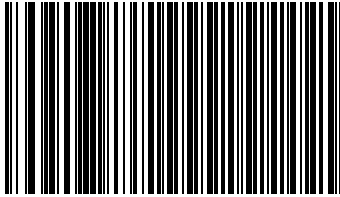

Port 17

Regulatory Information

Symbol Technologies, Inc., the Enterprise Mobility business of Motorola, Inc. ("Motorola").

All Symbol devices are designed to be compliant with rules and regulations in locations they are sold and will be labeled as required.

Any changes or modifications to Symbol equipment, not expressly approved by Symbol, could void the user's authority to operate the equipment.

Local language translations are available at the following web site:

<http://www.motorola.com/enterprisemobility/support>.

Health & Safety Recommendations



Ergonomic Recommendations

Caution: In order to avoid or minimize the potential risk of ergonomic injury follow the recommendations below. Consult with your local Health & Safety Manager to ensure that you are adhering to your company's safety programs to prevent employee injury.

- Reduce or eliminate repetitive motion
- Maintain a natural position
- Reduce or eliminate excessive force
- Keep objects that are used frequently within easy reach
- Perform tasks at correct heights
- Reduce or eliminate vibration
- Reduce or eliminate direct pressure
- Provide adjustable workstations
- Provide adequate clearance
- Provide a suitable working environment
- Improve work procedures.

Laser Devices



COMPLIES WITH 21CFR1040.10 AND 1040.11 EXCEPT FOR DEVIATIONS PURSUANT TO LASER NOTICE NO. 50, DATED JUNE 24, 2007 AND IEC 60825-1 (Ed. 2.0), EN60825-1:2007.

The laser classification is marked on one of the labels on the device.

Class 1 Laser devices are not considered to be hazardous when used for their intended purpose. The following statement is required to comply with US and international regulations:



CAUTION Use of controls, adjustments or performance of procedures other than those specified herein may result in hazardous laser light exposure.

Class 2 laser scanners use a low power, visible light diode. As with any very bright light source, such as the sun, the user should avoid staring directly into the light beam. Momentary exposure to a Class 2 laser is not known to be harmful.

Scanner Labeling

CLASS 1 LASER PRODUCT
LASER KLASSE 1
APPAREIL À LASER DE CLASSE 1

US CLASS I LASER PRODUCT
AVOID LONG TERM VIEWING OF
DIRECT LASER LIGHT

1类激光产品 警告: 二类激光产品 打开时, 不得直视

CAUTION - CLASS 2 LASER LIGHT
WHEN OPEN DO NOT STARE INTO
THE BEAM
VORSICHT- LASERLICHT
KLASSE 2, WENN ABDECKUNG
GEÖFFNET NICHT IN DEN STRAHL
BLICKEN
ATTENTION - LUMIÈRE
LASER DE CLASS 2, NE PAS
REGARDER DANS LE FAISCEAU



Laser Labels



In accordance with IEC60825-1 and EN60825, the following information is provided to the user:

ENGLISH

CLASS 1 CLASS 1 LASER PRODUCT
CLASS 2 LASER LIGHT
DO NOT STARE INTO BEAM
CLASS 2 LASER PRODUCT

DANISH / DANSK

KLASSE 1 KLASSE 1 LASERPRODUKT
KLASSE 2 LASERLYF
KLASSE 2 LASERPRODUKT

DUTCH / NEDERLANDS

KLASSE 1 KLASSE-1 LASERPRODUKT
KLASSE 2 LASERLICHT
NIET IN STRAAL STAREN
LASERPRODUKT,
KLASSE-2 LASERPRODUKT

FINNISH / SUOMI

LUOKKA 1 LUOKKA 1 LASERTUOTE
LASERVALO
ALÄ TULUJOTA SÄDETTÄ
LUOKKA 2 LASERTUOTE

FRENCH / FRANÇAIS

CLASSE 1 PRODUIT LASER DE CLASSE 1
CLASSE 2 LUMIERE LASER
NE PAS REGARDER LE RAYON FIXEMENT
PRODUIT LASER DE CLASSE 2

GERMAN / DEUTCH

KLASSE 1 LASERPRODUKT DER KLASSE 1
KLASSE 2 LASERSTRAHLEN
NICHT DIREKT IN DEN LASERSTRAHL SCHAUEN
LASERPRODUKT DER KLASSE 2

JAPANESE / 日本語

クラス1 クラス1 レーザ製品
クラス2 レーザ光線
光線を直視しないでください
クラス2 レーザ製品

CHINESE / 简体中文

1 类 1 类激光产品
2 类 激光
切勿直视光束
2 类激光产品

HEBREW

מוצר לייזר רמה 1 רמה 1
אור לייזר רמה 2 רמה 2
אין להביט אל תוך הזרם

ITALIAN / ITALIANO

CLASSE 1 PRODOTTO AL LASER DI CLASSE 1
CLASSE 2 LUCE LASER
SE IKKE IND I STRÅLEN

NON FISSARE IL
RAGGIOPRODOTTO
AL LASER DI CLASSE 2

NORWEGIAN / NORSK

KLASSE 1 LASERPRODUKT, KLASSE 1
KLASSE 2 LASERLYS IKKE STIRR INN I LYSSTRÅLEN
LASERPRODUKT, KLASSE 2

PORTUGUESE / PORTUGUÊS

CLASSE 1 PRODOTO LASER DA CLASSE 1
CLASSE 2 LUZ DE LASER NÃO FIXAR O RAIOS LUMINOSOS
PRODUTO LASER DA CLASSE 2

SPANISH / ESPAÑOL

CLASSE 1 PRODUCTO LASER DE LA CLASSE 1
CLASSE 2 LUZ LASER
NO MIRE FIJAMENTE EL HAZ
PRODUT LASER DE CLASSE 2

SWEDISH / SVENSKA

KLASS 1 LASERPRODUKT KLASSE 1
KLASS 2 LASERLJUS STIRRA INTE MOT STRÅLEN
LASERPRODUKT KLASSE 2

KOREAN / 한국어

1등급 1등급 레이저 제품
2등급 레이저 광선
이 광선을 주시하지 마십시오.
2등급 레이저 제품

Power Supply

Note: Use ONLY a LISTED Motorola, Type no. 50-14000 (5Vdc / 2A), or PWRS-14000 (5Vdc / 2A), Direct Plug-In Power supply, marked Class 2 or LPS (IEC60950-1, SELV). Use of Alternative Power Supply will invalidate any approvals given to this unit and may be dangerous.

Radio Frequency Interference Requirements-FCC



Note: This equipment has been tested and found to comply with the limits for a Class B digital device, pursuant to Part 15 of the FCC rules. These limits are designed to provide reasonable protection against harmful interference in a residential installation. This equipment generates, uses and can radiate radio frequency energy and, if not installed and used in accordance with the instructions, may cause harmful interference to radio communications. However there is no guarantee that interference will not occur in a particular installation. If this equipment does cause harmful interference to radio or television reception, which can be determined by turning the equipment off and on, the user is encouraged to try to correct the interference by one or more of the following measures:

- Reorient or relocate the receiving antenna
- Increase the separation between the equipment and receiver
- Connect the equipment into an outlet on a circuit different from that to which the receiver is connected
- Consult the dealer or an experienced radio/TV technician for help.

This device complies with Part 15 of the FCC Rules. Operation is subject to the following two conditions: (1) this device may not cause harmful interference, and (2) this device must accept any interference received, including interference that may cause undesired operation.

Radio Frequency Interference Requirements - Canada

This Class B digital apparatus complies with Canadian ICES-003.

Cet appareil numérique de la classe B est conforme à la norme NMB-003 du Canada.

Marking and European Economic Area (EEA)

Statement of Compliance



Symbol hereby declares that this device is in compliance with all the applicable Directives, 89/336/EEC, 73/23/EEC. A Declaration of Conformity may be obtained from <http://www.motorola.com/doc>.



Waste Electrical and Electronic Equipment (WEEE)

Bulgarish: За клиенти от ЕС: След края на полезния им живот всички продукти трябва да се връщат на Motorola за рециклиране. За информация относно връщането на продукти, моля отидете на адрес: <http://www.motorola.com/recycling/weee>.

Čeština: Pro zákazníky z EU: Všechny produkty je nutné po skončení jejich životnosti vrátit společnosti Motorola k recyklaci. Informace o způsobu vrácení produktu najdete na webové stránce: <http://www.motorola.com/recycling/weee>.

Dansk: Til kunder i EU: Alle produkter skal returneres til Motorola til recirkulering, når de er udtjent. Læs oplysningerne om returnering af produkter på: <http://www.motorola.com/recycling/weee>.

Deutsch: Für Kunden innerhalb der EU: Alle Produkte müssen am Ende ihrer Lebensdauer zum Recycling an Motorola zurückgesandt werden. Informationen zur Rücksendung von Produkten finden Sie unter <http://www.motorola.com/recycling/weee>.

Ελληνικά: Για πελάτες στην Ε.Ε.: Όλα τα προϊόντα, στο τέλος της διάρκειας ζωής τους, πρέπει να επιστρέφονται στην Motorola για ανακύκλωση. Για περισσότερες πληροφορίες σχετικά με την επιστροφή ενός προϊόντος, επισκεφθείτε τη διεύθυνση <http://www.motorola.com/recycling/weee> στο Διαδίκτυο.

Eesti: EL klientidele: kõik tooted tuleb nende eluea lõppedes tagastada taaskasutamise eesmärgil Motorola'ile. Lisainformatsiooni saamiseks toote tagastamise kohta külastage palun aadressi: <http://www.motorola.com/recycling/weee>.

English: For EU Customers: All products at the end of their life must be returned to Motorola for recycling. For information on how to return product, please go to: <http://www.motorola.com/recycling/weee>.

Español: Para clientes en la Unión Europea: todos los productos deberán entregarse a Motorola al final de su ciclo de vida para que sean reciclados. Si desea más información sobre cómo devolver un producto, visite: <http://www.motorola.com/recycling/weee>.

Français: Clients de l'Union Européenne : Tous les produits en fin de cycle de vie doivent être retournés à Motorola pour recyclage. Pour de plus amples informations sur le retour de produits, consultez : <http://www.motorola.com/recycle/weee>.

Italiano: per i clienti dell'UE: tutti i prodotti che sono giunti al termine del rispettivo ciclo di vita devono essere restituiti a Motorola al fine di consentirne il riciclaggio. Per informazioni sulle modalità di restituzione, visitare il seguente sito Web: <http://www.motorola.com/recycling/weee>.

Latviešu: ES klientiem: visi produkti pēc to kalpošanas mūža beigām ir jānogādā atpakaļ Motorola otrreizējai pārstrādei. Lai iegūtu informāciju par produktu nogādāšanu Motorola, lūdz, skatiet: <http://www.motorola.com/recycling/weee>.

Lietuvių: ES vartotojams: visi gaminiai, pasibaigus jų eksploatacijos laikui, turi būti grąžinti utilizuoti į kompaniją „Motorola“. Daugiau informacijos, kaip grąžinti gaminį, rasite: <http://www.motorola.com/recycling/weee>.

Magyar: Az EU-ban vásárlóknak: Minden tönkrement termékét a Motorola vállalatához kell eljuttatni újrahasznosítás céljából. A termék visszajuttatásának módjával kapcsolatos tudnivalóként látogasson el a <http://www.motorola.com/recycling/weee> weboldalra.

Malti: Għal klijenti fl-UE: il-prodotti kollha li jkunu waslu fl-aħħar tal-ħajja ta' l-użu tagħhom, iridu jiġu rritornati għand Motorola għar-riċiklaġġ. Għal aktar tagħrif dwar kif għandek tirritorna l-prodott, jekk jogħġbok żur: <http://www.motorola.com/recycling/weee>.

Nederlands: Voor klanten in de EU: alle producten dienen aan het einde van hun levensduur naar Motorola te worden teruggezonden voor recycling. Raadpleeg <http://www.motorola.com/recycling/weee> voor meer informatie over het terugzenden van producten.

Polski: Klienci z obszaru Unii Europejskiej: Produkty wycofane z eksploatacji należą zwrócić do firmy Motorola w celu ich utylizacji. Informacje na temat zwrotu produktów znajdują się na stronie internetowej <http://www.motorola.com/recycling/weee>.

Português: Para clientes da UE: todos os produtos no fim de vida devem ser devolvidos à Motorola para reciclagem. Para obter informações sobre como devolver o produto, visite: <http://www.motorola.com/recycling/weee>.

Românesc: Pentru clienții din UE: Toate produsele, la sfârșitul duratei lor de funcționare, trebuie returnate la Motorola pentru reciclare. Pentru informații despre returnarea produsului, accesați: <http://www.motorola.com/recycling/weee>.

Slovenski: Za kupce v EU: vsi izdelki se morajo po poteku življenjske dobe vrniti podjetju Motorola za reciklažo. Za informacije o vračilu izdelka obiščite: <http://www.motorola.com/recycling/weee>.

Slovenčina: Pre zákazníkov z krajín EU: Všetky výrobky musia byť po uplynutí doby ich životnosti vrátené spoločnosti Motorola na recykláciu. Bližšie informácie o vrátení výrobkov nájdete na: <http://www.motorola.com/recycling/weee>.

Suomi: Asiakkaat Euroopan unionin alueella: Kaikki tuotteet on palautettava kierrätettäväksi Motorola-yhtiöön, kun tuotetta ei enää käytetä. Lisätietoja tuotteen palauttamisesta on osoitteessa <http://www.motorola.com/recycling/weee>.

Svenska: För kunder inom EU: Alla produkter som uppnått sin livslängd måste returneras till Motorola för återvinning. Information om hur du returnerar produkten finns på <http://www.motorola.com/recycling/weee>.

Türkçe: AB Müşterileri için: Kullanım süresi dolan tüm ürünler geri dönüşürme için Motorola'ya iade edilmektedir. Ürünlerin nasıl iade edileceği hakkında bilgi için lütfen şu adresi ziyaret edin: <http://www.motorola.com/recycling/weee>.

Service Information

If you have a problem using the equipment, contact your facility's Technical or Systems Support. If there is a problem with the equipment, they will contact the Motorola Enterprise Mobility Support at:

<http://www.motorola.com/enterprisemobility/contactsupport>

For the latest version of this guide go to:

<http://www.motorola.com/enterprisemobility/manuals>



MOTOROLA

Motorola, Inc.
One Motorola Plaza
Holtsville, New York 11742, USA
1-800-927-9626
<http://www.motorola.com/enterprisemobility>

MOTOROLA and the Stylized M Logo and Symbol and the Symbol logo are registered in the U.S. Patent and Trademark Office. All other product or service names are the property of their registered owners. © Motorola, Inc. 2010



72-73950-03 Revision A - May 2010