

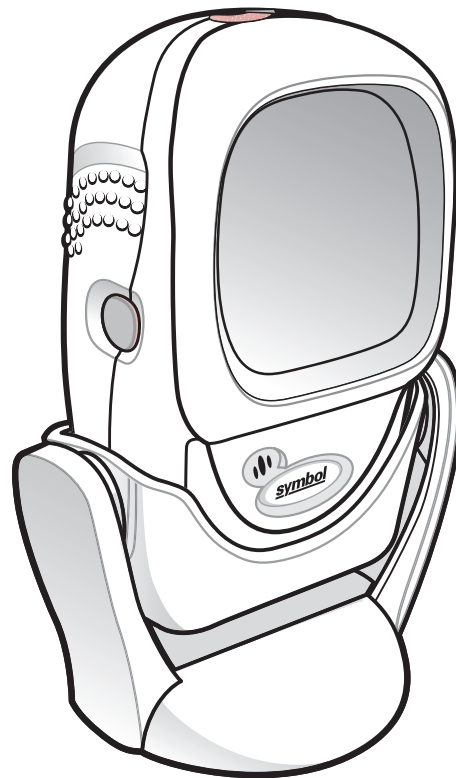

Symbol LS9208/LS9208i

Product Reference Guide



Symbol LS9208/LS9208i
Product Reference Guide

72E-60833-08

Revision A

February 2012

© 2008-2012 by Motorola, Inc. All rights reserved.

No part of this publication may be reproduced or used in any form, or by any electrical or mechanical means, without permission in writing from Motorola. This includes electronic or mechanical means, such as photocopying, recording, or information storage and retrieval systems. The material in this manual is subject to change without notice.

The software is provided strictly on an “as is” basis. All software, including firmware, furnished to the user is on a licensed basis. Motorola grants to the user a non-transferable and non-exclusive license to use each software or firmware program delivered hereunder (licensed program). Except as noted below, such license may not be assigned, sublicensed, or otherwise transferred by the user without prior written consent of Motorola. No right to copy a licensed program in whole or in part is granted, except as permitted under copyright law. The user shall not modify, merge, or incorporate any form or portion of a licensed program with other program material, create a derivative work from a licensed program, or use a licensed program in a network without written permission from Motorola. The user agrees to maintain Motorola’s copyright notice on the licensed programs delivered hereunder, and to include the same on any authorized copies it makes, in whole or in part. The user agrees not to decompile, disassemble, decode, or reverse engineer any licensed program delivered to the user or any portion thereof.

Motorola reserves the right to make changes to any software or product to improve reliability, function, or design.

Motorola does not assume any product liability arising out of, or in connection with, the application or use of any product, circuit, or application described herein.

No license is granted, either expressly or by implication, estoppel, or otherwise under any Motorola, Inc., intellectual property rights. An implied license only exists for equipment, circuits, and subsystems contained in Motorola products.

MOTOROLA and the Stylized M Logo and Symbol and the Symbol logo are registered in the US Patent & Trademark Office. Bluetooth is a registered trademark of Bluetooth SIG. Microsoft, Windows and ActiveSync are either registered trademarks or trademarks of Microsoft Corporation. All other product or service names are the property of their respective owners.

Motorola, Inc.
One Motorola Plaza
Holtsville, New York 11742-1300
<http://www.motorolasolutions.com>

Warranty

For the complete Motorola hardware product warranty statement, go to:
<http://www.motorola.com/enterprisemobility/warranty>.

Revision History

Changes to the original manual are listed below:

Change	Date	Description
-01 Rev A	4/2003	Initial release
-02 Rev A	2/2004	Add missing information
-03 Rev A	4/2004	Add Time Delay to Low Power parameter bar code and update format
-04 Rev A	9/2005	Add Simple Comm Port Emulation bar code
-05 Rev A	2/2007	Update service information, add parameter bar codes for Bookland ISBN, new UPC supplemental decode options, report software version, report MIMIC version, report Synapse cable
-06 Rev A	5/2008	Removed IBM XT bar code and keyboard from Keyboard Wedge chapter, added French Belgian country codes, corrected MSI default lengths, added note regarding Code ID and No Read, added RSM 2.0 ADF options (string search and new move cursor options), added Send Pause and Comma bar codes to ADF chapter, changed RSS references to GS1 DataBar.
-07 Rev A	8/2008	Updates: <ul style="list-style-type: none"> - add LS9208i model - Motorola URLs - UCC/EAN-128 name change to GS1-128 - add LS9208i decode zone - custom defaults - new LS9208i defaults for Timeout Between Same Symbol, GS1 DataBar-14, GS1 DataBar Expanded.
-08 Rev A	2/2012	Removed Patents section. Removed medium beeper volume. Beeper vendor changed which limited the beeper volume to 2 volumes (low and high).

Table of Contents

Patents.....	ii
Warranty	ii
Revision History	iii
Introduction	ix
Chapter Descriptions	ix
Notational Conventions.....	x
Related Documents	xi
Service Information.....	xi

Chapter 1: Getting Started

Introduction	1-1
Unpacking Your Scanner	1-2
Setting Up the Scanner	1-2
Installing the Interface Cable	1-2
Connecting Power (if required)	1-3
Synapse Interface	1-3
Connecting a Synapse Cable Interface	1-5
Configuring Your Scanner	1-5
Removing the Interface Cable	1-5

Chapter 2: Scanning

Introduction	2-1
Scanning in Single-Line Mode	2-2
Scanning in Omni Mode	2-3
Beeper Definitions	2-5
Selecting Beeper Volume using Trigger	2-7
LED Definitions	2-7
Aiming	2-8
Decode Zones	2-9
Integrated Electronic Article Surveillance (EAS)	2-11
Deactivation Antenna for Checkpoint EAS Systems	2-11
EAS Deactivation Range	2-11

Symbol LS9208/LS9208i Host Interface Cables and EAS	2-11
Different Checkpoint EAS Models	2-11
Checkpoint Contact Information	2-11
Mounting Template	2-12

Chapter 3: Maintenance and Technical Specifications

Introduction	3-1
Maintenance	3-1
Troubleshooting	3-2
Technical Specifications	3-3
Scanner Signal Descriptions	3-5

Chapter 4: User Preferences

Introduction	4-1
Scanning Sequence Examples	4-1
Errors While Scanning	4-2
User Preferences Default Parameters	4-2
User Preferences	4-3
Default Parameters	4-3
Beeper Tone	4-4
Beeper Volume	4-5
Volume Change Trigger Delay	4-6
Laser On Time	4-7
Beep After Good Decode	4-7
Low Power Blink	4-8
Scan Pattern Mode	4-9
Single-Line Aim Duration	4-10
Timeout Between Decodes	4-11
Timeout Between Decodes, Same Symbol	4-11
Timeout Between Decodes, Different Symbol	4-11
Time Delay to Low Power Mode	4-12
Linear UPC/EAN Decode	4-13

Chapter 5: Keyboard Wedge Interface

Introduction	5-1
Connecting a Keyboard Wedge Interface	5-2
Keyboard Wedge Default Parameters	5-3
Keyboard Wedge Host Parameters	5-4
Keyboard Wedge Host Types	5-4
Keyboard Wedge Country Types (Country Codes)	5-5
Ignore Unknown Characters	5-8
Keystroke Delay	5-9
Intra-Keystroke Delay	5-10
Alternate Numeric Keypad Emulation	5-10
Caps Lock On	5-11
Caps Lock Override	5-11
Convert Wedge Data	5-12

Function Key Mapping	5-13
FN1 Substitution	5-13
Send Make Break	5-14
Keyboard Maps	5-15
ASCII Character Set	5-16

Chapter 6: RS-232 Interface

Introduction	6-1
Connecting an RS-232 Interface	6-2
RS-232 Default Parameters	6-3
RS-232 Host Parameters	6-4
RS-232 Host Types	6-6
Baud Rate	6-8
Parity	6-10
Check Receive Errors	6-11
Hardware Handshaking	6-12
None	6-12
Standard RTS/CTS	6-13
RTS/CTS Option 1	6-13
RTS/CTS Option 2	6-13
RTS/CTS Option 3	6-13
Software Handshaking	6-14
None	6-14
ACK/NAK	6-14
ENQ	6-14
ACK/NAK with ENQ	6-15
XON/XOFF	6-15
Host Serial Response Time-out	6-15
RTS Line State	6-17
Stop Bit Select	6-17
Data Bits	6-18
Beep on <BEL>	6-18
Intercharacter Delay	6-19
Nixdorf Beep/LED Options	6-20
Ignore Unknown Characters	6-21
ASCII / Character Set	6-22

Chapter 7: USB Interface

Introduction	7-1
Connecting a USB Interface	7-2
USB Default Parameters	7-3
USB Host Parameters	7-4
USB Device Type	7-4
USB Country Keyboard Types (Country Codes)	7-6
USB Keystroke Delay	7-9
USB CAPS Lock Override	7-10
USB Ignore Unknown Characters	7-10
Emulate Keypad	7-11

USB Keyboard FN1 Substitution	7-11
Function Key Mapping	7-12
Simulated Caps Lock	7-12
Convert Case	7-13
ASCII Character Set	7-14

Chapter 8: IBM 468X/469X Interface

Introduction	8-1
Connecting to an IBM 468X/469X Host	8-2
IBM Default Parameters	8-2
IBM 468X/469X Host Parameters	8-3
Port Address	8-3
Convert Unknown to Code 39	8-4

Chapter 9: Wand Emulation Interface

Introduction	9-1
Connecting Using Wand Emulation	9-2
Wand Emulation Default Parameters	9-3
Wand Emulation Host Parameters	9-4
Wand Emulation Host Types	9-4
Leading Margin (Quiet Zone)	9-5
Polarity	9-6
Ignore Unknown Characters	9-6
Convert All Bar Codes to Code 39	9-7
Convert Code 39 to Full ASCII	9-8

Chapter 10: 123Scan

Introduction	10-1
Communication With the 123Scan PC Based Configuration Tool	10-1
123Scan Parameter	10-1

Chapter 11: Symbolologies

Introduction	11-1
Scanning Sequence Examples	11-1
Errors While Scanning	11-1
Symbology Default Parameters	11-2
UPC/EAN	11-5
Enable/Disable UPC-A/UPC-E	11-5
Enable/Disable UPC-E1	11-6
Enable/Disable EAN-13/JAN-13/EAN-8/JAN-8	11-7
Enable/Disable Bookland EAN	11-8
Decode UPC/EAN Supplementals	11-9
User-Programmable Supplementals	11-13
UPC/EAN Supplemental Redundancy	11-13
Transmit UPC-A/UPC-E/UPC-E1 Check Digit	11-14
UPC-A Preamble	11-16

UPC-E Preamble	11-17
UPC-E1 Preamble	11-18
Convert UPC-E to UPC-A	11-19
Convert UPC-E1 to UPC-A	11-19
EAN Zero Extend	11-20
Bookland ISBN Format	11-21
UCC Coupon Extended Code	11-22
Code 128	11-23
Enable/Disable Code 128	11-23
Enable/Disable GS1-128 (formerly UCC/EAN-128)	11-23
Enable/Disable ISBT 128	11-24
Code 128 Decode Performance	11-24
Code 128 Decode Performance Level	11-25
Code 39	11-26
Enable/Disable Code 39	11-26
Enable/Disable Trioptic Code 39	11-27
Convert Code 39 to Code 32	11-28
Code 32 Prefix	11-28
Set Lengths for Code 39	11-29
Code 39 Check Digit Verification	11-30
Transmit Code 39 Check Digit	11-30
Enable/Disable Code 39 Full ASCII	11-31
Code 39 Buffering (Scan & Store)	11-31
Buffer Data	11-32
Clear Transmission Buffer	11-32
Transmit Buffer	11-33
Overfilling Transmission Buffer	11-33
Attempt to Transmit an Empty Buffer	11-33
Code 39 Decode Performance	11-34
Code 39 Decode Performance Level	11-35
Code 93	11-36
Enable/Disable Code 93	11-36
Set Lengths for Code 93	11-36
Code 11	11-38
Code 11	11-38
Set Lengths for Code 11	11-38
Code 11 Check Digit Verification	11-40
Transmit Code 11 Check Digits	11-41
Interleaved 2 of 5 (ITF)	11-42
Enable/Disable Interleaved 2 of 5	11-42
Set Lengths for Interleaved 2 of 5	11-42
I 2 of 5 Check Digit Verification	11-44
Transmit I 2 of 5 Check Digit	11-45
Convert I 2 of 5 to EAN-13	11-45
Discrete 2 of 5 (DTF)	11-46
Enable/Disable Discrete 2 of 5	11-46
Set Lengths for Discrete 2 of 5	11-46
Chinese 2 of 5	11-48
Enable/Disable Chinese 2 of 5	11-48
Codabar (NW - 7)	11-48

Enable/Disable Codabar	11-48
Set Lengths for Codabar	11-49
CLSI Editing	11-50
NOTIS Editing	11-50
MSI	11-51
Enable/Disable MSI	11-51
Set Lengths for MSI	11-51
MSI Check Digits	11-53
Transmit MSI Check Digit(s)	11-53
MSI Check Digit Algorithm	11-54
GS1 DataBar (formerly RSS, Reduced Space Symbology)	11-55
GS1 DataBar-14	11-55
GS1 DataBar Limited	11-56
GS1 DataBar Expanded	11-56
Convert GS1 DataBar to UPC/EAN	11-57
Symbology - Specific Security Levels	11-59
Redundancy Level	11-59
Redundancy Level 1	11-59
Redundancy Level 2	11-59
Redundancy Level 3	11-60
Redundancy Level 4	11-60
Security Level	11-61
Security Level 0	11-61
Security Level 1	11-61
Security Level 2	11-61
Security Level 3	11-61
Symbology - Intercharacter Gap	11-62

Chapter 12: Miscellaneous Scanner Options

Introduction	12-1
Scanning Sequence Examples	12-1
Errors While Scanning	12-1
Miscellaneous Default Parameters	12-2
Miscellaneous Scanner Parameters	12-3
Transmit Code ID Character	12-3
Prefix/Suffix Values	12-4
FN1 Substitution Values	12-5
Scan Data Options	12-6
Transmit "No Read" Message	12-8
Report Version	12-9
Report MIMIC Version	12-9
Report Synapse Cable	12-9

Chapter 13: Advanced Data Formatting

Introduction	13-1
Rules: Criteria Linked to Actions	13-1
Using ADF Bar Codes	13-2
ADF Bar Code Menu Example	13-2
Rule 1: The Code 128 Scanning Rule	13-3
Rule 2: The UPC Scanning Rule	13-3
Alternate Rule Sets	13-3
Rules Hierarchy (in Bar Codes)	13-4
Default Rules	13-5
Special Commands	13-6
Pause Duration	13-6
Begin New Rule	13-6
Save Rule	13-6
Erase	13-7
Quit Entering Rules	13-8
Disable Rule Set	13-8
Criteria	13-10
Code Types	13-10
Code Lengths	13-16
Message Containing A Specific Data String	13-26
Specific String at Start	13-26
Specific String, Any Location	13-26
Specific String Search	13-27
Any Message OK	13-27
Rule Belongs To Set	13-27
Actions	13-29
Send Data	13-29
Setup Field(s)	13-36
Move Cursor	13-38
Skip Ahead	13-40
Skip Back	13-43
Send Preset Value	13-46
Modify Data	13-48
Remove All Spaces	13-48
Crunch All Spaces	13-48
Stop Space Removal	13-48
Remove Leading Zeros	13-48
Stop Zero Removal	13-48
Pad Data with Spaces	13-50
Pad Data with Spaces (Continued)	13-51
Pad Data with Zeros	13-60
Beeps	13-70
Send Keystroke (Control Characters and Keyboard Characters)	13-71
Control Characters	13-71
Keyboard Characters	13-82
Send ALT Characters	13-114
Send Keypad Characters	13-123
Send Function Key	13-135
Send Right Control Key	13-155

Send Graphic User Interface Characters 13-155
Turn On/Off Rule Sets 13-167
Alphanumeric Keyboard 13-170

Appendix A: Standard Default Parameters

Appendix B: Programming Reference

Symbol Code Identifiers B-1
AIM Code Identifiers B-2

Appendix C: Sample Bar Codes

Code 39 C-1
UPC/EAN C-2
 UPC-A, 100 % C-2
 EAN-13, 100 % C-2
Code 128 C-2
Interleaved 2 of 5 C-3
GS1 DataBar-14 C-3

Appendix D: Numeric Bar Codes

0, 1 D-1
2, 3, 4, 5 D-2
6, 7, 8, 9 D-3
Cancel D-4

Glossary

Index

About This Guide

Introduction

The *Symbol LS9208/LS9208i Product Reference Guide* provides general instructions for setting up, operating, maintaining, and troubleshooting the Symbol LS9208/LS9208i scanners.

Chapter Descriptions

Topics covered in this guide are as follows:

- [Chapter 1, Getting Started](#) provides a product overview and unpacking instructions.
- [Chapter 2, Scanning](#) describes parts of the scanner, beeper and LED definitions, and how to use the scanner in hand-held and presentation modes.
- [Chapter 3, Maintenance and Technical Specifications](#) provides information on caring for the scanner, troubleshooting, and technical specifications.
- [Chapter 4, User Preferences](#) provides programming bar codes for selecting user preference features for the scanner.
- [Chapter 5, Keyboard Wedge Interface](#) includes information for setting up the scanner for Keyboard Wedge operation.
- [Chapter 6, RS-232 Interface](#) includes information for setting up the scanner for RS-232 operation.
- [Chapter 7, USB Interface](#) includes information for setting up the scanner for USB operation.
- [Chapter 8, IBM 468X/469X Interface](#) includes all information for setting up the scanner with IBM 468X/469X POS systems.
- [Chapter 9, Wand Emulation Interface](#) includes all information for setting up the scanner for Wand emulation operation.
- [Chapter 10, 123Scan](#), a PC-based scanner configuration tool, provides information to communicate with the 123Scan program.
- [Chapter 11, Symbologies](#) describes all symbology features and provides programming bar codes for selecting these features for the scanner.

- [Chapter 12, Miscellaneous Scanner Options](#) includes features frequently used to customize how data transmits to the host device.
- [Chapter 13, Advanced Data Formatting](#) (ADF) describes how to customize scanned data before transmitting to the host.
- [Appendix A, Standard Default Parameters](#) provides a table of all host devices and miscellaneous scanner defaults.
- [Appendix B, Programming Reference](#) provides a table of AIM code identifiers, ASCII character conversions, and keyboard maps.
- [Appendix C, Sample Bar Codes](#) includes sample bar codes of various code types.
- [Appendix D, Numeric Bar Codes](#) includes the numeric bar codes to scan for parameters requiring specific numeric values.

Notational Conventions

The following conventions are used in this document:

- *Italics* are used to highlight chapters and sections in this and related documents
- bullets (•) indicate:
 - Action items
 - Lists of alternatives
 - Lists of required steps that are not necessarily sequential
- Sequential lists (e.g., those that describe step-by-step procedures) appear as numbered lists.
- Throughout the programming bar code menus, asterisks (*) are used to denote default parameter settings.

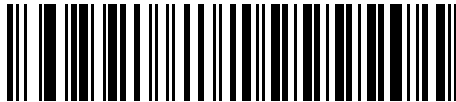

* Indicates Default ——— *Baud Rate 9600 ——— Feature/Option



NOTE This symbol indicates something of special interest or importance to the reader. Failure to read the note will not result in physical harm to the reader, equipment or data.



CAUTION This symbol indicates that if this information is ignored, the possibility of data or material damage may occur.



WARNING! This symbol indicates that if this information is ignored the possibility that serious personal injury may occur.

Related Documents

The *Symbol LS9208 Quick Start Guide* (p/n 72-74322-xx) and *Symbol LS9208i Quick Start Guide* (p/n 72-114100-xx) provide general information on getting started with the scanner. They include basic set-up and operation instructions.

For the latest version of this guide and all guides, go to: www.motorolasolutions.com/support.

Service Information

If you have a problem using the equipment, contact your facility's technical or systems support. If there is a problem with the equipment, they will contact the Motorola Solutions Global Customer Support Center at: <http://www.motorolasolutions.com/support>.

When contacting Motorola Solutions support, please have the following information available:

- Serial number of the unit
- Model number or product name
- Software type and version number

Motorola responds to calls by e-mail, telephone or fax within the time limits set forth in service agreements.

If your problem cannot be solved by Motorola Solutions support, you may need to return your equipment for servicing and will be given specific directions. Motorola is not responsible for any damages incurred during shipment if the approved shipping container is not used. Shipping the units improperly can possibly void the warranty.

If you purchased your business product from a Motorola business partner, please contact that business partner for support.

Chapter 1 Getting Started

Introduction

The Symbol LS9208/LS9208i projection scanners provide multiple scan pattern capabilities that support various applications at the POS (point of sale). For fast, intuitive, hands-free scanning, use the rastering, 100-line, omni-directional scan pattern. To read bar code menus and pick lists, use the Single-Scan line. Pick up the scanner to scan heavy or bulky merchandise. The scanner reads all retail symbologies and has multi-interface capability to support all popular POS devices.

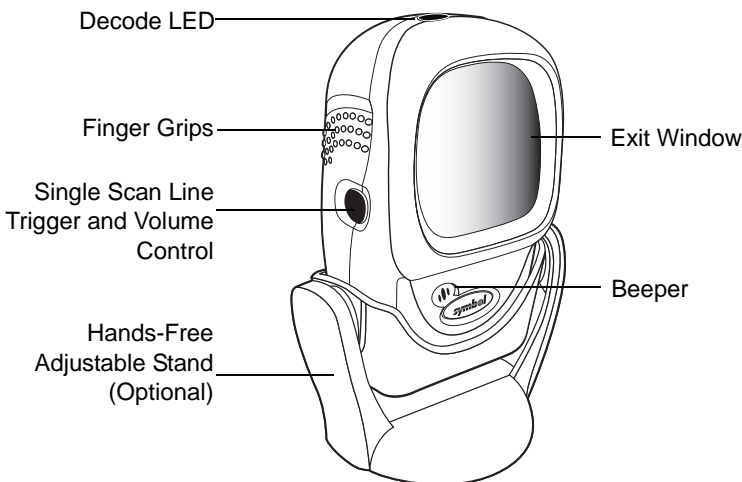

Figure 1-1 Symbol LS9208/LS9208i Scanner

The Symbol LS9208/LS9208i scanners support the following interfaces:

- Standard RS-232. Scan bar code menus to establish proper communication of the scanner with the host.
- Keyboard Wedge. The host interprets scanned data as keystrokes.
 - International Keyboards supported (for Windows® environment): North American, German, French, Spanish, Italian, Swedish, UK English, Brazilian/Portuguese and Japanese.
 - International Keyboards supported (for Win XP/2000™ environment): French Canadian
 - International Keyboards supported (for Win 95/98 environment): French Canadian

- Wand Emulation. The scanner is connected to a portable data terminal, a controller, or host which collects the data as wand data and decodes it.
- IBM 468X/469X hosts. Scan bar code menus to establish proper communications of the scanner with the IBM terminal.
- USB hosts. The scanner autodetects a USB host and defaults to the HID keyboard interface type. Scan bar code menus to select other USB interface types.
- International Keyboards supported (for Windows environment): North America, German, French, French International, Spanish, Italian, Swedish, British, and Japanese.
- Synapse capability which enables connection to a wide variety of host systems using a Synapse and Synapse adapter cable to connect to a host. The scanner autodetects Synapse.

Unpacking Your Scanner

Remove the scanner from its packing and inspect it for damage. If the scanner was damaged in transit, contact Motorola Enterprise Mobility Support. See [Service Information on page xi](#) for contact information. **KEEP THE PACKING.** It is the approved shipping container and should be used if you ever need to return your equipment for servicing.

Setting Up the Scanner

Installing the Interface Cable

1. Connect the interface cable to the host computer.
2. Plug the interface cable modular connector into the interface cable port on the rear of the scanner (see [Figure 1-2](#)).
3. Push the connector into the housing until you hear a click. *The green LED lights and three short high beeps sound, indicating that the scanner is operational.*

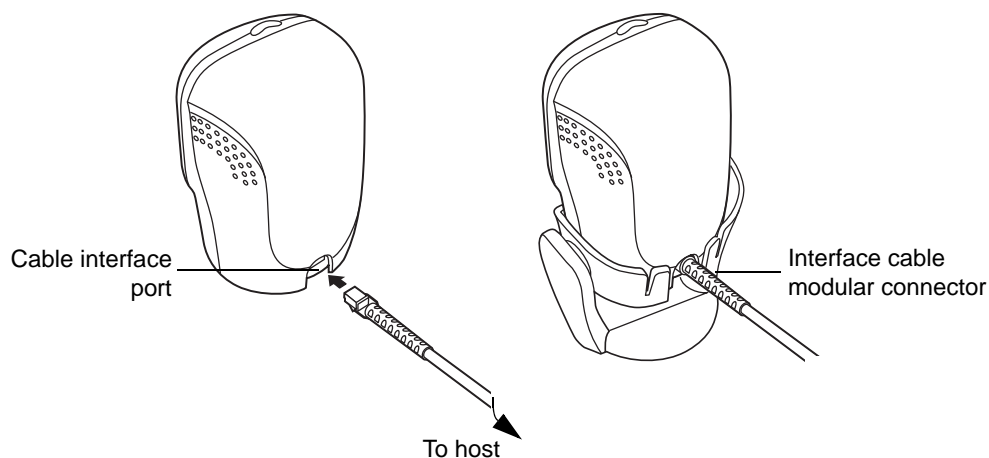

Figure 1-2 *Installing the Interface Cable*



NOTE Different hosts require different cables. The connectors illustrated in each host chapter are examples only. Your connectors may be different than those illustrated, but the steps to connect the scanner is the same.

Connecting Power (if required)

If the host does not provide power to the scanner, connect external power to the scanner:

1. Connect the interface cable to the back of the scanner, as described in [Installing the Interface Cable on page 1-2](#).
2. Connect the other end of the interface cable to the host (refer to the host manual to locate the correct port).
3. Plug the power supply into the power jack on the interface cable.
4. Plug the other end of the power supply into an AC outlet.

Synapse Interface

Auto-detection of a Synapse cable varies in duration depending on the type of Synapse connection. If a scanner is connected to a host using a Synapse cable, use the Auxiliary Synapse Port connection. In all other cases when using a Synapse cable, use the default setting.

To disconnect and reconnect the scanner from a Synapse cable that is connected to a live host, use the Plug and Play setting. Do not change this setting from the default if an on-board wedge host is enabled.

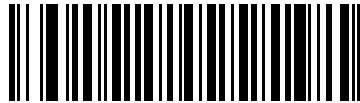

***Standard Synapse Connection**

Synapse Interface (continued)



Auxiliary Synapse Port Connection



Plug and Play Synapse Connection

Connecting a Synapse Cable Interface

✓ **NOTE** See the Synapse Interface Guide provided with the Synapse cable for detailed setup instructions.

Symbol's Synapse Smart Cables enable interfacing to a variety of hosts. The appropriate Synapse cable has the built-in intelligence to detect the connected host.

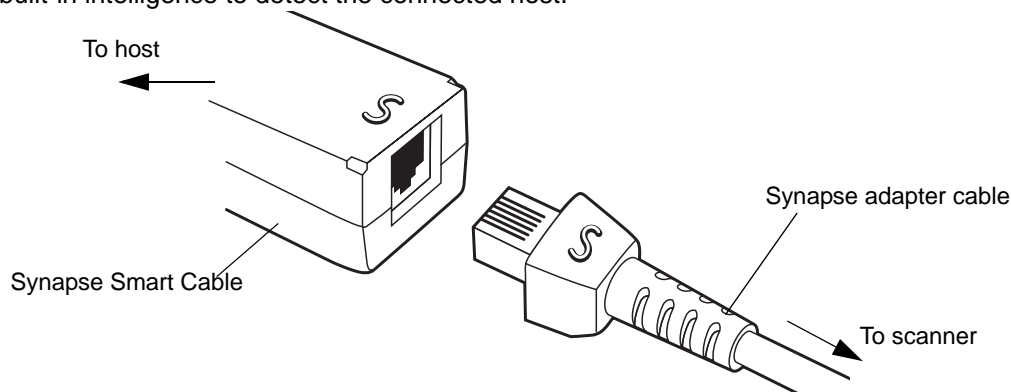

Figure 1-3 Synapse Cable Connection

1. Plug the Synapse adapter cable (p/n 25-32463-xx) into the bottom of the scanner, as described in [Installing the Interface Cable on page 1-2](#).
2. Align the 'S' on the Synapse adapter cable with the 'S' on the Synapse Smart Cable and plug the cable in.
3. Connect the other end of the Synapse Smart Cable to the host.

Configuring Your Scanner

To configure the scanner: use the bar codes included in this manual, or use the 123Scan configuration program.

See [Chapter 4, User Preferences](#) for information about programming the scanner using bar code menus. See [Chapter 10, 123Scan](#) to configure the scanner using 123Scan. The program includes a help file.

The scanner supports RS-232, IBM 468X/469X, Keyboard Wedge, Wand Emulation, USB, and Synapse to interface to a host system. Each host-specific chapter describes how to set up these connections.

Removing the Interface Cable

To remove the interface cable:

1. Unplug the installed cable's modular connector by depressing the connector clip and gently pulling back.
2. Follow the steps for [Installing the Interface Cable on page 1-2](#) to connect a new cable.

Chapter 2 Scanning

Introduction

This chapter includes techniques involved in scanning bar codes, beeper and LED definitions, and general instructions and tips about scanning.

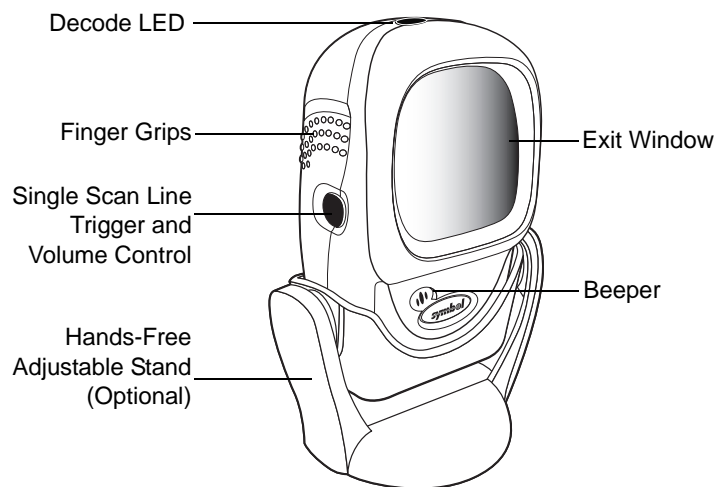

Figure 2-1 *Scanner Parts*

Scanning in Single-Line Mode

Install and program the scanner. See each host chapter and [Chapter 4, User Preferences](#), [Chapter 11, Symbologies](#), [Chapter 12, Miscellaneous Scanner Options](#), and [Chapter 13, Advanced Data Formatting](#) for programming instructions. For assistance, contact your local supplier or Motorola Enterprise Mobility Support. See [page xi](#) for contact information.

1. Ensure all connections are secure. See the host chapter for your host.
2. Pick up the scanner. **Press and then release the trigger.** A single scan line displays.

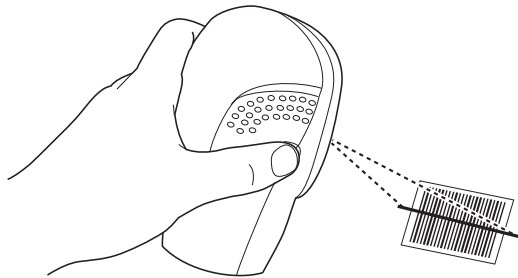
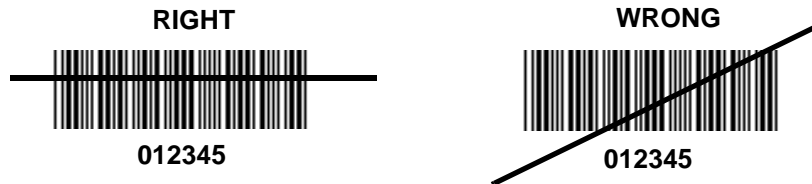

Figure 2-2 Scanning in Hand-Held Mode

3. Ensure the scan line crosses every bar and space of the symbol.



4. Press and hold the trigger until either:
 - a. The scanner reads the bar code. The scanner beeps, the LED flashes, and the laser turns off.
 - b. The scanner does not read the bar code and the laser turns off.
5. Release the trigger. The aim scan line reappears. To read another bar code in single-line mode, repeat steps 2, 3, and 4. Repeat this step as often as required.

After a programmable time period, the omni-directional scan pattern displays, indicating the scanner is ready to read bar codes without use of the trigger.

For beeper definitions, see [Table 2-1](#).

Scanning in Omni Mode

In this mode, an omni scan pattern provides rapid, orientation-free scanning. You can use this scan pattern for either presentation mode or hand-held scanning.

To scan a bar code, present it to the window of the scanner (see [Figure 2-7 on page 2-5](#)) or from side to side in a sweeping motion (see [Figure 2-8 on page 2-5](#)).

1. Ensure all cable connections are secure.
2. Insert the scanner in the optional hands-free stand by placing the front of the scanner into the stand's cradle (see [Figure 2-3](#)), or place the scanner on a flat surface (see [Figure 2-4](#)).

✓ **NOTE** To mount the hands-free adjustable stand, see [Mounting Template on page 2-12](#).

3. To scan a bar code, present the bar code and ensure the scan lines cross every bar and space of the symbol. The scan pattern becomes steady when the scanner detects the bar code. See [Figure 2-5 on page 2-4](#) for scanning in presentation mode and [Figure 2-6 on page 2-4](#) for scanning in hand-held mode.
4. Upon successful decode, the scanner beeps and the green LED flashes momentarily.

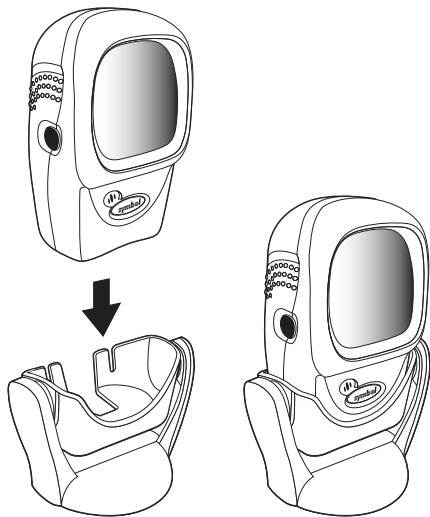

Figure 2-3 Scanner in the Stand

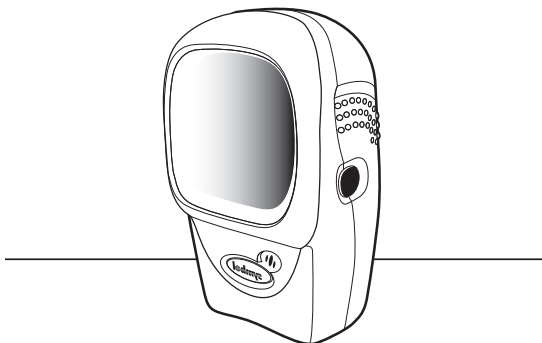

Figure 2-4 Scanner Standing Alone

A rastering, 100-line, omni-directional scan pattern provides rapid, orientation-free scanning. You can use this scan pattern in either presentation or hand-held mode.

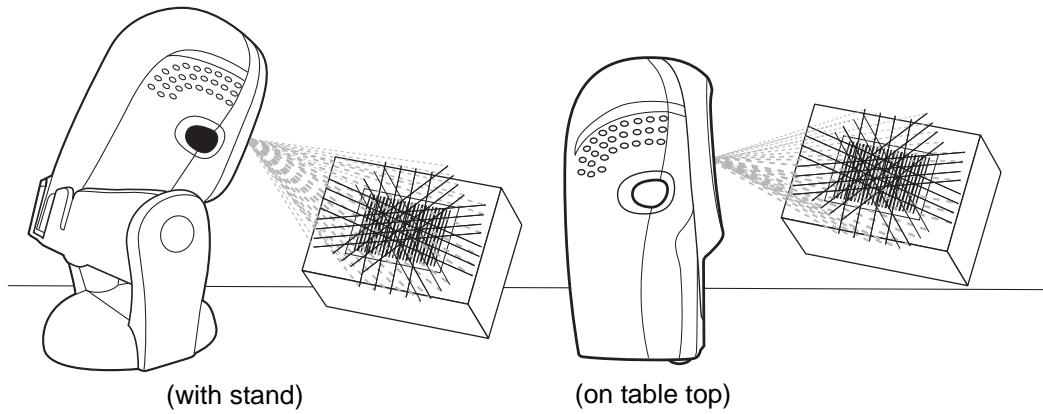

Figure 2-5 *Presentation Mode*

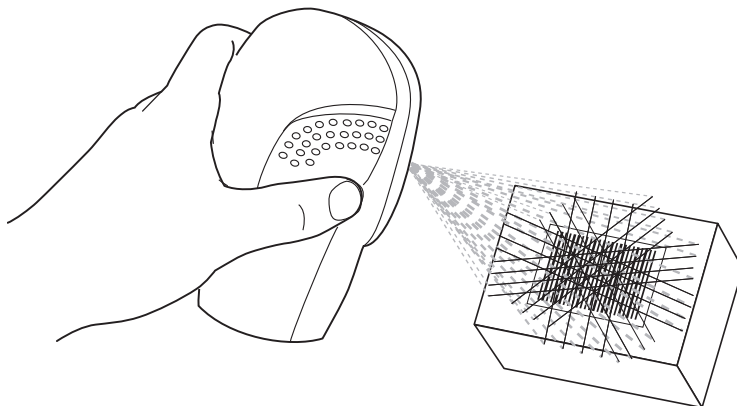

Figure 2-6 *Hand-Held Mode*

To scan a bar code, present it to the exit window of the scanner or move it from side-to-side in a sweeping motion.

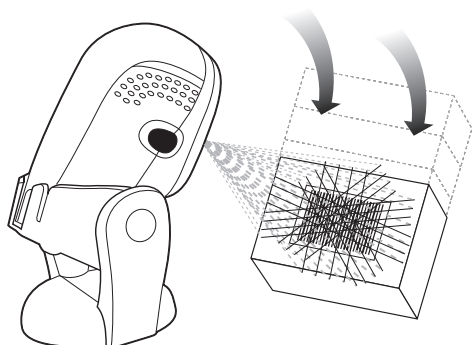

Figure 2-7 Presentation scanning

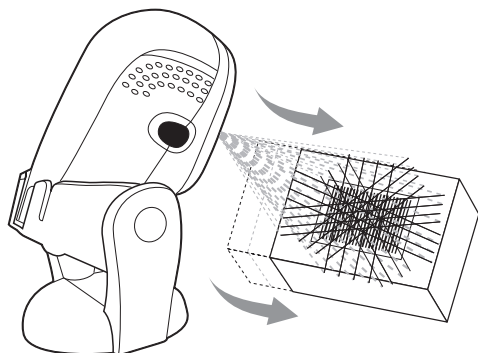

Figure 2-8 Swipe scanning



NOTE To mount the optional hands-free adjustable stand, see [Mounting Template on page 2-12](#).

Beeper Definitions

The scanner emits different beeper sequences and patterns to communicate with the user. [Table 2-1](#) defines beep sequences that occur during both normal scanning and while programming the scanner.

Table 2-1 Standard Beeper Definitions

Beeper Sequence	Indication
Standard Use	
3 short high beeps	Power up.
Short high beep	A bar code symbol was decoded (if decode beeper is enabled).
4 long low beeps	A transmission error was detected in a scanned symbol. The data is ignored. This occurs if a unit is not properly configured. Check option setting.
5 low beeps	Conversion or format error.

Table 2-1 Standard Beeper Definitions (Continued)

Beeper Sequence	Indication
Lo/hi/lo beep	ADF transmit error.
Hi/hi/hi/lo beep	RS-232 receive error.
Parameter Menu Scanning	
Short high beep	Correct entry scanned or correct menu sequence performed.
Lo/hi beep	Input error, incorrect bar code or Cancel scanned, wrong entry, incorrect bar code programming sequence; remain in program mode.
Hi/lo beep	Keyboard parameter selected. Enter value using bar code keypad.
Hi/lo/hi/lo beep	Successful program exit with change in the parameter setting.
Low/hi/low/hi beep	Out of host parameter storage space. Scan Set Factory Defaults on page 4-3 .
Code 39 Buffering	
Hi/lo beep	New Code 39 data was entered into the buffer.
3 long high beeps	Code 39 buffer is full.
Lo/hi/lo beep	The Code 39 buffer was erased or there was an attempt to clear or transmit an empty buffer.
Lo/hi beep	A successful transmission of buffered data.
Host Specific	
USB only	
4 short high beeps	Scanner has not completed initialization. Wait several seconds and scan again.
Scanner gives a power-up beep after scanning a USB Device Type.	Communication with the bus must be established before the scanner can operate at the highest power level.
This power-up beep occurs more than once.	The USB bus may put the scanner in a state where power to the scanner is cycled on and off more than once. This is normal and usually happens when the PC cold boots.
RS-232 only	
1 short high beep	A <BEL> character is received and Beep on <BEL> is enabled.

Selecting Beeper Volume using Trigger

The scanner emits a short beep when it successfully reads a bar code. To change the volume of the beep either scan the appropriate bar code in [Beeper Volume on page 4-5](#), or use the trigger as follows:

1. Press and hold the trigger for an extended period of time (approximately 5 seconds). The scanner cycles through the available settings emitting a 2-beep tone at each setting.
2. To select a particular setting, release the trigger after you hear the desired 2-beep tone.

LED Definitions

In addition to beeper sequences, the scanner communicates with the user using an LED display. [Table 2-2](#) defines LED flashes that display during scanning.

Table 2-2 *Standard LED Definitions*

LED	Indication
Off	No power is applied to the scanner.
Green	The scanner is on and ready to scan.
Momentary flash	A bar code was successfully decoded.
Slow continuous flashing	The scanner is in programming mode.
Fast continuous flashing	There is a internal problem; the laser is shut off for regulatory reasons.

Aiming

Do not hold the scanner directly over the bar code. Laser light reflecting *directly* back into the scanner from the bar code is known as specular reflection. This specular reflection can make decoding difficult.

You can tilt the scanner up to 45° forward or back and achieve a successful decode ([Figure 2-9](#)). Simple practice quickly shows what tolerances to work within.

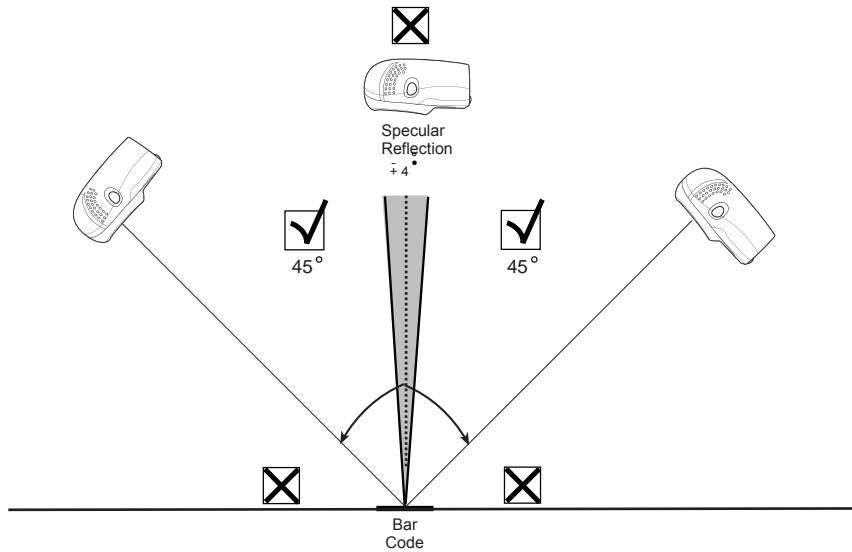
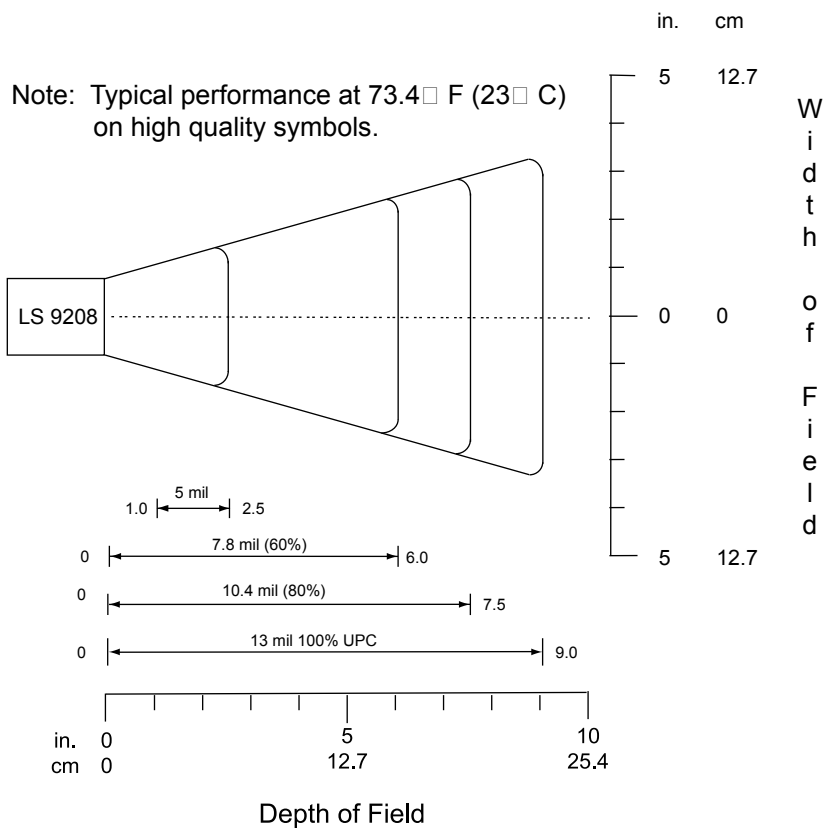

Figure 2-9 Maximum Tilt Angles and Dead Zone

Decode Zones



*Minimum distance determined by symbol length and scan angle

Figure 2-10 Symbol LS9208 Decode Zone

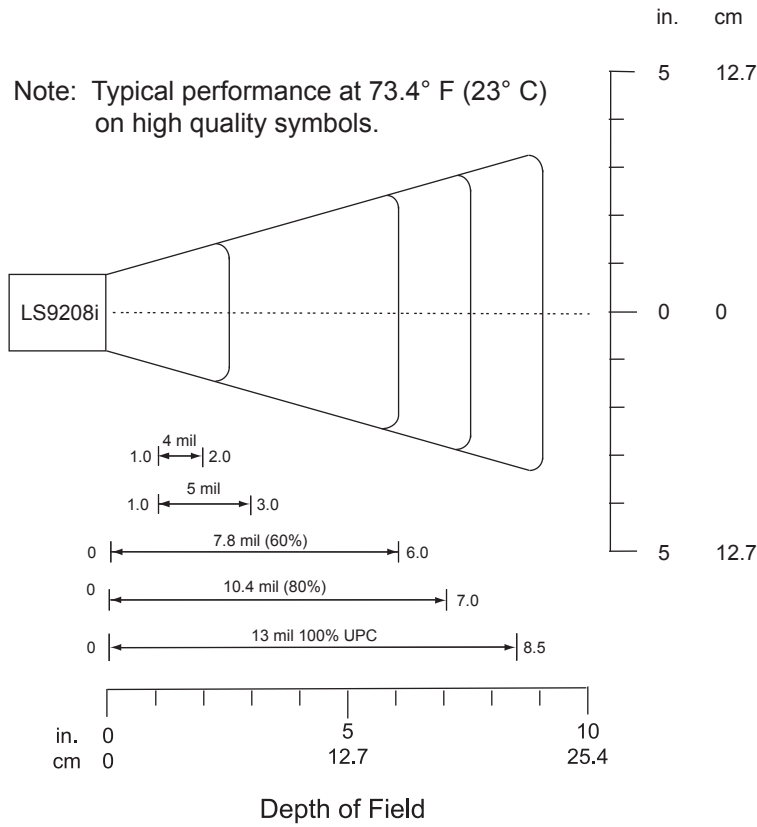

*Minimum distance determined by symbol length and scan angle

Figure 2-11 Symbol LS9208i Decode Zone

Integrated Electronic Article Surveillance (EAS)

Deactivation Antenna for Checkpoint EAS Systems

The scanners' optional EAS deactivation feature includes an integrated RF antenna which, when attached to a Checkpoint Systems, Inc. RF-EAS deactivation system, supports deactivation of RF-EAS security labels while scanning a product at the Point-of-Sale. This allows removing the merchandise from the store without activating the security alarm.

- ✓ **NOTE** Contact your local Checkpoint representative to help connect the EAS deactivation system to insure proper operation.

EAS Deactivation Range

EAS Deactivation Range depends on several factors including:

- **EAS Tags.** EAS tags are produced by several different manufacturers, each with a different performance level. This variance in performance can also vary the deactivation range.
- **Cable.** The length of the EAS antenna cable wire is directly related to deactivation range. The longer the EAS deactivation antenna wires, the greater the signal loss, which decreases EAS deactivation range.
- **Calibration of the Checkpoint RF-EAS Deactivation System.** There are several adjustments that can be made on the Checkpoint Deactivation System side. Contact Checkpoint Systems, Inc. for details.
- **Check Stand Construction.** Check stand construction also affects EAS deactivation range. Too much metal or wood blocking the RF signal can dampen or severely reduce the RF-EAS signal.

- ✓ **NOTE** Contact your local Checkpoint representative to help connect the EAS deactivation system to insure proper operation.

Symbol LS9208/LS9208i Host Interface Cables and EAS

The scanners use Symbol's universal scanner cables, which include several varieties that incorporate RF-EAS deactivation signal wires. Universal EAS scanner cables are only available as Straight Cables. No coiled EAS cables are available for use with EAS. Coiled cables are longer than straight cables, which results in RF-EAS signal loss. As a coiled cable is stretched, the EAS deactivation range is further reduced. This is not acceptable operation for EAS security systems.

Different Checkpoint EAS Models

There are several Checkpoint EAS systems available. The Symbol LS9208/LS9208i are specified to work with CounterPoint IV, V, VI, VII & IX models from Checkpoint Systems, Inc.

Checkpoint Contact Information

Checkpoint Headquarters (New Jersey): 800-257-5540.

Outside the United States: +1-856-848-1800.

Mounting Template

Use the template to mount the optional hands-free stand on a flat surface. Two #6-32 screws, 5/8 in. long, are recommended.

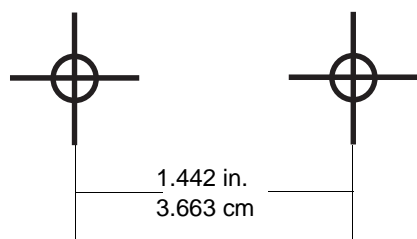

Chapter 3 Maintenance and Technical Specifications

Introduction

This chapter includes suggested scanner maintenance, troubleshooting, technical specifications, and signal descriptions (pinouts).

Maintenance

Cleaning the exit window is the only maintenance required. A dirty window may affect scanning accuracy.

- Do not allow any abrasive material to touch the window.
- Remove any dirt particles with a damp cloth.
- Wipe the window using a tissue moistened with ammonia/water.
- Do not spray water or other cleaning liquids directly into the window.

Troubleshooting

Table 3-1 *Troubleshooting*

Problem	Possible Causes	Possible Solutions
The omni-line scan pattern does not display when you follow the directions for installing the interface cable on page 1-2	No power to the scanner.	Ensure the host has power, and is on. If the scanner uses a separate power supply, ensure it's connected to a working AC outlet.
	Interface cable is not properly connected.	Check for loose cable connections.
Scan line(s) display, but bar code cannot be read.	Scanner is not programmed to read the bar code type.	Ensure scanner is programmed to read the bar code type you are scanning.
	Bar code is damaged.	Try scanning other bar codes of the same bar code type.
	Bar code is too far from scanner.	Move the bar code closer to the scanner.
	Triggered scanning is being used incorrectly.	Press the trigger to activate decoding. Follow directions on page 2-2 .
	The host has disabled scanning or overridden parameter settings.	See the technical person in charge of scanning.
Bar code is decoded, but not transmitted to the host.	Scanner is not programmed for the correct host type.	Scan the appropriate host type bar code.
Scanned data is incorrectly displayed on the host.	Scanner is not programmed to work with the host. Check scanner host type parameters or editing options.	Ensure proper host is selected. For RS-232, ensure the scanner's communication parameters match the host's settings. For keyboard wedge, ensure scanner is programmed with the correct country code and that the CAPS LOCK key is off. Ensure editing options (e.g., UPCE-to-UPCA Conversion) are properly programmed.
Although the green Power LED is on, the scanner does not produce the omni-directional scan pattern.	The scanner has gone into the Low Power "Shut Down" Mode.	Press the trigger to awaken the unit, or change the setting for Low Power Blink on page 4-8 .



NOTE If after performing these checks the symbol still does not scan, contact your distributor or Motorola Enterprise Mobility Support. See [Service Information on page xi](#) for contact information.

Technical Specifications

Table 3-2 *Technical Specifications*

Item	Description
Physical Characteristics	
Dimensions: without stand: Height Width Depth with stand: Height Width Depth	5.51 in. (14 cm) 3.49 in. (8.8 cm) 2.96 in. (7.5 cm) 7.18 in. (18.24 cm) 4.83 in. (12.27 cm) 3.73 in. (9.47 cm)
Weight	Scanner only: 10.2 oz/320 g With adjustable stand: 21.5 oz/670 g
Power Source	Power drawn from host terminal or external power supply; depends on host type.
Voltage	5.0 VDC \pm 10%
Nominal Current	390 mA
Power	2 watts
Mounting Options	Adjustable multi-mount stand
Color	Cash Register White and Twilight Black
Performance Characteristics	
Light Source	650nm visible laser diode
Yaw Tolerance (Typical) ¹	Omnidirectional: \pm 50° Single scan line: \pm 50°
Pitch Tolerance (Typical) ¹	Omnidirectional: \pm 50° Single scan line: \pm 60°
Roll Tolerance (Typical) ¹	Omnidirectional: 0 to 360° Single scan line: \pm 40°
Print Contrast	25% minimum reflective difference
¹ Refers to 100% UPC bar code (80% contrast) located 4 in./10 cm from the scanner nose.	
Scan Patterns	Omnidirectional: 20 interlocking lines, 5 scan lines, 4 lines per angle rastering @ 5Hz Single scan line capability
Scan Rate	Omnidirectional: 1500 scans/second Single scan line: 75 scans/second

Table 3-2 *Technical Specifications (Continued)*

Item	Description
Depth of Field	0-9 in./0-22.9 cm @ 13 mil (100% UPC/EAN)
Nominal Working Range	5 mil: (38%) 1 to 2.5 in./ 2.5 to 6.4 cm 7.8 mil: (60%) 0 to 6 in./ 0 to 15.2 cm 10.4 mil: (80%) 0 to 7.5 in./ 0 to 19 cm 13 mil: (100%) 0 to 9 in./ 0 to 22.9 cm
Width of Field	1.6 in. (40 mm) @ Face 6.7 in. (170 mm) @ 9 in.
Minimum Resolution	5 mil
Decode Capability	UPC/EAN/JAN, UPC/EAN with Supplementals, UCC/ EAN 128, Code 128, ISBT 128, Code 39, Code 39 Trioptic, Interleaved 2 of 5, Discrete 2 of 5, Code 93, Code 11, Codabar, MSI, GS1 DataBar variants
Interfaces Supported	USB, RS 232, IBM® 468X/9X, Keyboard Wedge, Wand and Synapse™ (allows connectivity to virtually every POS host type)
User Environment	
Operating Temperature	32° to 104°F (0° to 40°C)
Storage Temperature	-40° to 158°F (-40° to 70°C)
Humidity	5% to 95% (non-condensing)
Drop Specifications	Functions normally after repeated 4 ft (1.2m) drops to concrete
Ambient Light Immunity	Immune to normal artificial indoor and natural outdoor (direct sunlight) lighting conditions. Fluorescent, Incandescent, Mercury Vapor and Sodium Vapor: 450 Ft Candles (4,844 Lux) Sunlight: 8000 Ft Candles (86,111 Lux)
EAS Support	Optional Checkpoint Electronic Article Surveillance EAS
Regulatory	
Electrical Safety	Certified to UL 1950, CSA C22.2 No. 950 EN60825
Laser Safety	CDRH Class IIa Laser Product IEC 60825 Class 1 Laser Product
EMC	CISPR B, FCC B

Scanner Signal Descriptions

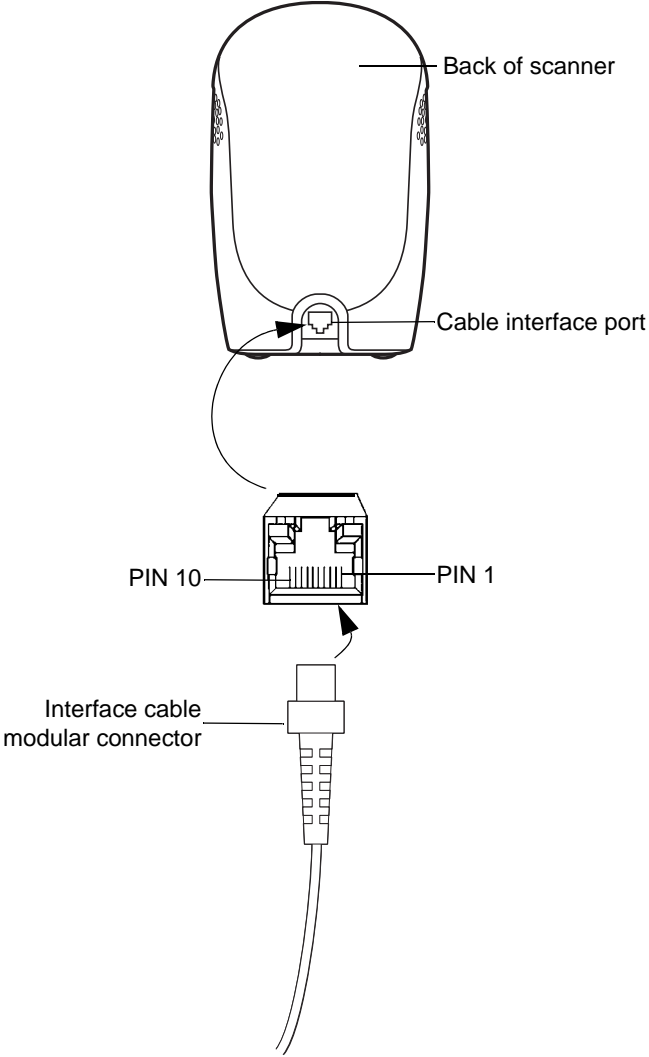

Figure 3-1 Scanner Cable Pinouts

The signal descriptions in [Table 3-3](#) apply to the connector on the scanner and are for reference only.

Chapter 4 User Preferences

Introduction

You can program the scanner to perform various functions, or activate different features. This chapter describes each user preference feature and provides programming bar codes for selecting these features for the scanner. Before programming, follow the instructions in [Chapter 1, Getting Started](#).

The scanner ships with the settings shown in the [User Preferences Default Table on page 4-2](#) (also see [Appendix A, Standard Default Parameters](#) for all host and miscellaneous scanner defaults). If the default values suit requirements, programming is not necessary.

To set feature values, scan single bar codes or short bar code sequences. The settings are stored in non-volatile memory and are preserved even when the scanner is powered down.

If you are not using a Synapse or USB cable you must select a host type (see each host chapter for specific host information). After the power-up beeps sound, select a host type. You only need to do this once, upon the first power-up when connected to a new host.

To return all features to their default values, scan **Restore Defaults** on [page 4-3](#). Throughout the programming bar code menus, asterisks (*) indicate default values.



* Indicates Default — ***High Frequency** — Feature/Option

Scanning Sequence Examples

In most cases, scan one bar code to set a specific parameter value. For example, to set the beeper tone to high, simply scan the **High Frequency** (beeper tone) bar code listed under [Beeper Tone on page 4-4](#). The scanner issues a short high beep and the LED turns green, signifying a successful parameter entry.

Other parameters, such as Serial Response Time-Out or setting Data Transmission Formats, require scanning several bar codes. See [Host Serial Response Time-out on page 6-15](#) and [Scan Data Options on page 12-6](#) for descriptions of this procedure.

Errors While Scanning

Unless otherwise specified, to correct an error during a scanning sequence, just re-scan the correct parameter.

User Preferences Default Parameters

Table 4-1 lists the defaults for user preferences parameters. To change any option, scan the appropriate bar code(s) provided in the User Preferences section beginning on [page 4-3](#).

✓ **NOTE** See [Appendix A, Standard Default Parameters](#) for all user preferences, hosts, symbologies, and miscellaneous default parameters.

Table 4-1 *User Preferences Default Table*

Parameter	Default	Page Number
User Preferences		
Set Default Parameter	Restore Defaults	4-3
Beeper Tone	High	4-4
Beeper Volume	High	4-5
Volume Change Trigger Delay	5.0 Sec	4-6
Laser On Time	3.0 Sec	4-7
Beep After Good Decode	Enable	4-7
Low Power Blink	Blink	4-8
Scan Pattern Mode	Rastering	4-9
Single-Line Aim Duration	2 sec	4-10
Timeout Between Same Symbol	0.6 sec (LS9208) 0.5 sec (LS9208i)	4-11
Timeout Between Different Symbols	0.2 sec	4-11
Time Delay to Low Power Mode	30 Minutes	4-12
Linear UPC/EAN Decode	Disable	4-13

User Preferences

Default Parameters

The scanner can be reset to two types of defaults: factory defaults or custom defaults. Scan the appropriate bar code below to reset the scanner to its default settings and/or set the scanner's current settings as the custom default.

- **Restore Defaults** - Resets all default parameters as follows:
 - If custom default values were configured (see **Write to Custom Defaults**), the custom default values are set for all parameters each time the **Restore Defaults** bar code below is scanned.
 - If no custom default values were configured, the factory default values are set for all parameters each time the **Restore Defaults** bar code below is scanned. (For factory default values, see [Table A-1 on page A-1.](#))
- **Set Factory Defaults** - Scan the **Set Factory Defaults** bar code below to eliminate all custom default values and set the scanner to factory default values. (For factory default values, see [Table A-1 on page A-1.](#))
- **Write to Custom Defaults** - Custom default parameters can be configured to set unique default values for all parameters. After changing all parameters to the desired default values, scan the **Write to Custom Defaults** bar code below to configure custom defaults.



***Restore Defaults**



Set Factory Defaults



Write to Custom Defaults

Beeper Tone

To select a decode beep frequency (tone), scan the **Low Frequency**, **Medium Frequency**, or **High Frequency** bar code.



Low Frequency

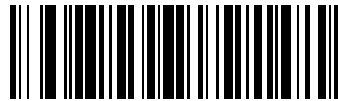

Medium Frequency

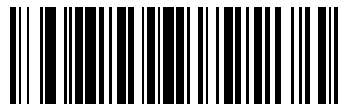

***High Frequency**

Beeper Volume

To select a beeper volume, scan the **Low Volume** or **High Volume** bar code.



Low Volume



***High Volume**

Volume Change Trigger Delay

To adjust the volume on the scanner, press and hold the trigger for a certain amount of time. The scanner changes the volumes, and beeps with the new volume.

This parameter controls the length of time needed to hold the trigger to adjust the volume.



Volume Trigger Duration 3 sec



***Volume Trigger Duration 5 sec**



Volume Trigger Duration 7 sec

Laser On Time

This parameter sets the maximum time that decode processing continues during a scan attempt. It is programmable in 0.1 second increments from 0.5 to 10 seconds. The default Laser On Time is 3.0 seconds.

To set a Laser On Time, scan the bar code below. Next, scan two numeric bar codes from [Appendix D, Numeric Bar Codes](#) that correspond to the desired on time. Include a leading zero for single digit numbers. For example, to set an On Time of 0.5 seconds, scan the bar code below, then scan the **0** and **5** bar codes. To correct an error or change a selection, scan **Cancel** on [page D-4](#).



Laser On Time

Beep After Good Decode

Scan a bar code below to select whether or not the scanner beeps after a good decode. If you select **Do Not Beep After Good Decode**, the beeper still operates during parameter menu scanning and indicates error conditions.

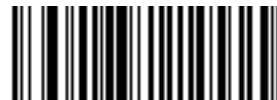

*Beep After Good Decode
(Enable)

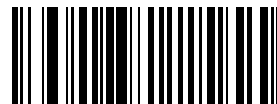

Do Not Beep After Good Decode
(Disable)

Low Power Blink

After a period of inactivity, the scanner enters a reduced power mode. This parameter controls how aggressively power is conserved, and therefore determines the method of waking the scanner up.

If you select **Low Power - Blink Mode**, the scanner (after a period of inactivity) blinks infrequently to save power. To restore the scanner to full power mode, use the scanner by presenting a bar code.

If you select **Motor and Laser Shut Down**, the scanner (after a period of inactivity) turns off the motor and laser, but leaves the green Power LED lit. Depress the trigger to awaken the scanner to its full power mode.



***Low Power - Blink Mode**



Low Power - Shut Down

Scan Pattern Mode

The scanner has a very aggressive scan pattern that is both omnidirectional and raster. For a static omnidirectional pattern, scan the **Omnidirectional Pattern** bar code.



***Rastering Omnidirectional Pattern**



Omnidirectional Pattern

Single-Line Aim Duration

The scanner can enter the single-line scan mode by tapping the trigger. Once in this mode, upon each trigger pull the scanner attempts to decode the bar code in front of it. After a period of inactivity while the trigger is not pressed, the scanner reverts to the omnidirectional pattern.

This parameter controls the length of the period of inactivity in single-line mode before the scanner reverts to the omnidirectional pattern.



***Aim Duration 2 sec**



Aim Duration 3 sec



Aim Duration 4 sec



Aim Duration 5 sec

Timeout Between Decodes

Timeout Between Decodes, Same Symbol

This parameter sets the minimum time between decodes of different symbols. It is programmable in 0.1-second increments from 0.0 to 9.9 seconds. Motorola recommends setting this above 0.4 seconds. The default for the LS9208 is 0.6 seconds. The default for the LS9208i is 0.5 seconds.

Scan the bar code below to select a new timeout. Next, scan two numeric bar codes from [Appendix D, Numeric Bar Codes](#) that correspond to the desired timeout. Include a leading zero for single digit numbers. For example, to set a timeout of 0.5 seconds, scan the bar code below, then scan the **0** and **5** bar codes. To correct an error or change a selection, scan **Cancel** on [page D-4](#).



Timeout Between Same Symbol

Timeout Between Decodes, Different Symbol

This parameter sets the minimum time between decodes of different symbols. It is programmable in 0.1-second increments from 0.0 to 9.9 seconds. The default is 0.2 seconds.

Scan the bar code below to select a new timeout. Next, scan two numeric bar codes from [Appendix D, Numeric Bar Codes](#) that correspond to the desired timeout. Include a leading zero for single digit numbers. For example, to set a timeout of 0.5 seconds, scan the bar code below, then scan the **0** and **5** bar codes. To correct an error or change a selection, scan **Cancel** on [page D-4](#).



Timeout Between Different Symbol

Time Delay to Low Power Mode

This parameter sets the time that the scanner remains active after any scanning activity. Scan one of the four options. Depending on the selection, the scanner enters a sleep mode 15, 30, 60, or 90 minutes after the last attempted decode. To awaken the scanner, see the explanation of [Low Power Blink](#) on page 4-8.



15 Minutes



***30 Minutes**



60 Minutes



90 Minutes

Time Delay to Low Power Mode (Continued)



Extended (127.5 Hours)

Linear UPC/EAN Decode

This option applies to code types containing two adjacent blocks (e.g., UPC-A, EAN-8, EAN-13). Enable this to transmit a bar code only when both the left and right blocks are successfully decoded within one laser scan. Enable this option when bar codes are in proximity to each other.



Enable Linear UPC/EAN Decode



*Disable Linear UPC/EAN Decode

Chapter 5 Keyboard Wedge Interface

Introduction

This chapter provides Keyboard Wedge interface information for setting up the scanner. This interface connects the scanner between the keyboard and host computer. The scanner translates the bar code data into keystrokes. The host computer accepts the keystrokes as if they originate from the keyboard.

This mode of operation adds bar code reading functionality to a system designed for manual keyboard input. In this mode the keyboard keystrokes are simply passed through.

Throughout the programming bar code menus, asterisks (*) indicate default values.



* Indicates Default *North American — Feature/Option

Connecting a Keyboard Wedge Interface

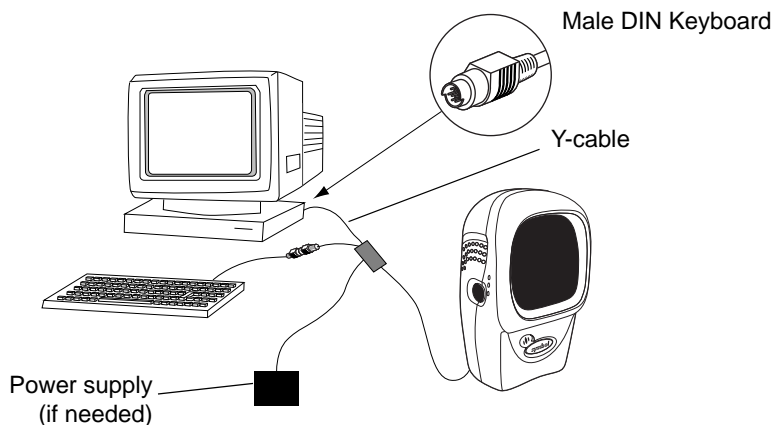

Figure 5-1 Keyboard Wedge Connection with Y-cable

To connect the Keyboard Wedge Y-cable:

1. Power off the host and unplug the keyboard connector.
2. Attach the modular connector of the Y-cable to the cable interface port on the scanner. See [Installing the Interface Cable on page 1-2](#).
3. Connect the round male DIN host connector of the Y-cable to the keyboard port on the host device.
4. Connect the round female DIN keyboard connector of the Y-cable to the keyboard.
5. If needed, attach the optional power supply to the connector in the middle of the Y-cable.
6. Ensure all connections are secure.
7. Power on the host system.
8. Scan the appropriate bar codes in this chapter to configure the scanner.

Keyboard Wedge Default Parameters

[Table 5-1](#) lists the defaults for Keyboard Wedge host parameters. To change any option, scan the appropriate bar code(s) provided in the Keyboard Wedge Host Parameters section beginning on [page 5-4](#).

✓ **NOTE** See [Appendix A, Standard Default Parameters](#) for all user preferences, hosts, symbologies, and miscellaneous default parameters.

Table 5-1 Keyboard Wedge Host Default Table

Parameter	Default	Page Number
Keyboard Wedge Host Parameters		
Keyboard Wedge Host Type	IBM PC/AT & IBM PC Compatibles ¹	5-4
Country Types (Country Codes)	North American	5-5
Ignore Unknown Characters	Send Bar Codes	5-8
Keystroke Delay	No Delay	5-9
Intra-Keystroke Delay	Disable	5-10
Alternate Numeric Keypad Emulation	Disable	5-10
Caps Lock On	Disable	5-11
Caps Lock Override	Disable	5-11
Convert Wedge Data	No Convert	5-12
Function Key Mapping	Disable	5-13
FN1 Substitution	Disable	5-13
Send Make Break	Disable	5-14

¹User selection is required to configure this interface and this is the most common selection.

Keyboard Wedge Host Parameters

Keyboard Wedge Host Types

Select a keyboard wedge host by scanning one of the following bar codes.



IBM PC/AT & IBM PC Compatibles¹



IBM PS/2 (Model 30)



IBM AT NOTEBOOK



NCR 7052



NOTE ¹User selection is required to configure this interface and this is the most common selection.

Keyboard Wedge Country Types (Country Codes)

Scan the bar code corresponding to the keyboard type. If your keyboard type is not listed, see [Alternate Numeric Keypad Emulation on page 5-10](#).



***North American**



German Windows



French Windows



French Canadian Win 95/98

Keyboard Wedge Country Types (Continued)



French Canadian Windows XP/2000



French Belgian Windows



Spanish Windows

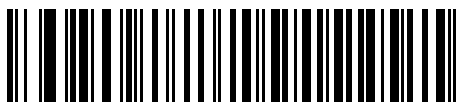

Italian Windows

Keyboard Wedge Country Types (Continued)



Swedish Windows



UK English Windows



Japanese Windows



Brazilian/Portuguese Windows

Ignore Unknown Characters

Unknown characters are characters the host does not recognize.

Select **Send Bar Codes With Unknown Characters** to send all bar code data except for unknown characters. The scanner issues no error beeps.

Select **Do Not Send Bar Codes With Unknown Characters** to send bar code data up to the first unknown character. The scanner issues an error beep.

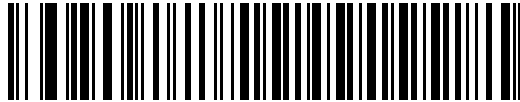

***Send Bar Codes With Unknown
Characters**



Do Not Send Bar Codes With Unknown Characters

Keystroke Delay

This is the delay in milliseconds between emulated keystrokes. Scan a bar code to increase the delay when hosts require slower data transmission.



***No Delay**



Medium Delay (20 msec)



Long Delay (40 msec)

Intra-Keystroke Delay

Enable this to insert an additional delay between each emulated key depression and release. This sets the Keystroke Delay parameter to a minimum of 5 msec as well.



Enable

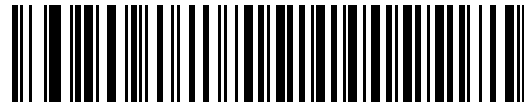

***Disable**

Alternate Numeric Keypad Emulation

This allows emulation of most other country keyboard types not listed in [Keyboard Wedge Country Types \(Country Codes\) on page 5-5](#) in a Microsoft operating system environment.

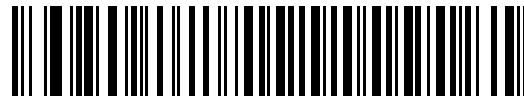

Enable Alternate Numeric Keypad

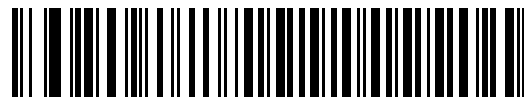

***Disable Alternate Numeric Keypad**

Caps Lock On

When enabled, the scanner emulates keystrokes as if the Caps Lock key is always pressed.

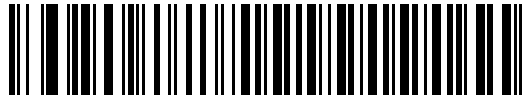

Enable Caps Lock On

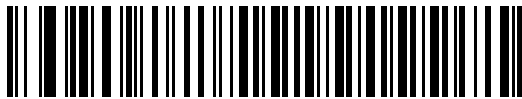

***Disable Caps Lock On**

Caps Lock Override

When enabled, on AT or AT Notebook hosts, the keyboard ignores the state of the Caps Lock key. Therefore, an 'A' in the bar code is sent as an 'A' regardless of the state of the keyboard's Caps Lock key.



Enable Caps Lock Override



***Disable Caps Lock Override**



NOTE If both Caps Lock On and Caps Lock Override are enabled, Caps Lock Override takes precedence.

Convert Wedge Data

Enable this to convert all bar code data to the selected case.



Convert to Upper Case



Convert to Lower Case



***No Convert**

Function Key Mapping

ASCII values under 32 are normally sent as control-key sequences (see [Table 7-2 on page 7-14](#)). Enable this parameter to send the keys in bold in place of the standard key mapping. Table entries that do not have a bold entry remain the same whether or not this parameter is enabled.

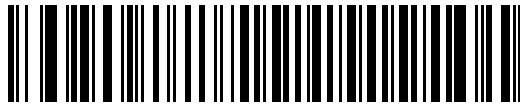

Enable

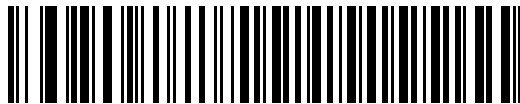

***Disable**

FN1 Substitution

Enable this to replace any FN1 characters in an EAN 128 bar code with a user-selected Key Category and Key Value (see [FN1 Substitution Values on page 12-5](#)).



Enable

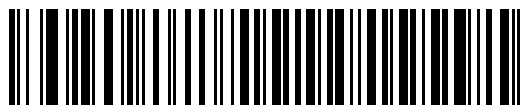

***Disable**

Send Make Break

When enabled, the scan codes for releasing a key are not sent.

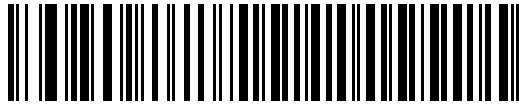

***Send Make and Break Scan Codes**

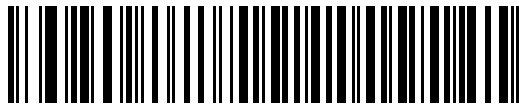

Send Make Scan Code Only

Keyboard Maps

Use the following keyboard maps for reference for prefix/suffix keystroke parameters. To program the prefix/suffix values, see the bar codes on [page 12-4](#).

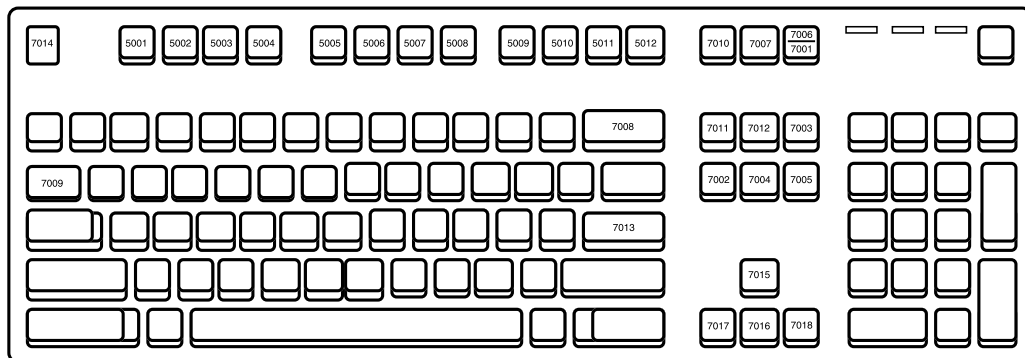

Figure 5-1. IBM PS2 Type Keyboard

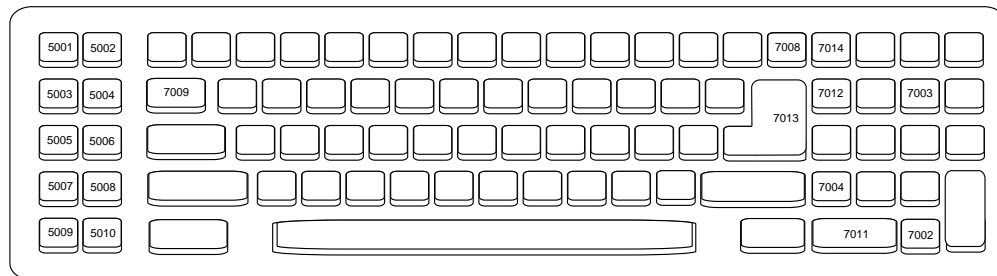

Figure 5-2. IBM PC/AT

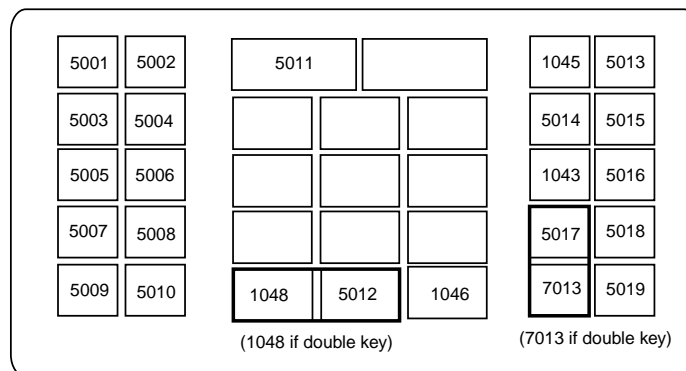

Figure 5-3. NCR 7052 32-KEY

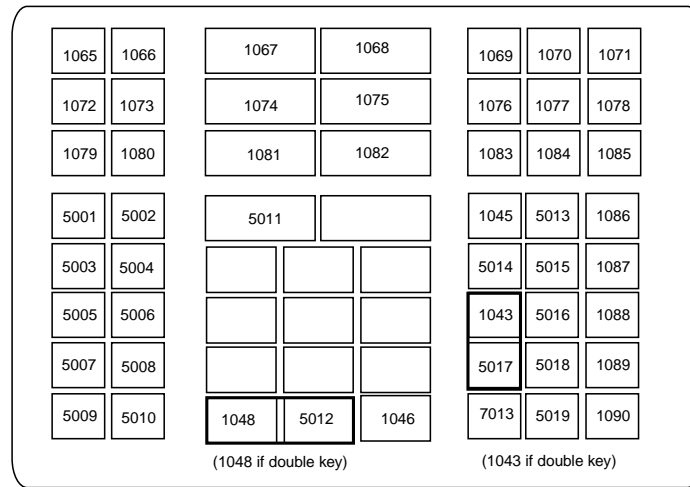

Figure 5-4. NCR 7052 58-KEY

ASCII Character Set



NOTE Code 39 Full ASCII interprets the bar code special character (\$ + % /) preceding a Code 39 character and assigns an ASCII character value to the pair. For example, when Code 39 Full ASCII is enabled and a **+B** is scanned, it is interpreted as **b**, **%J** as **?**, and **%V** as **@**. Scanning **ABC%i** outputs the keystroke equivalent of **ABC >**.

Table 5-2 Keyboard Wedge ASCII Character Set

ASCII Value	Full ASCII Code 39 Encode Char.	Keystroke
1001	\$A	CTRL A
1002	\$B	CTRL B
1003	\$C	CTRL C
1004	\$D	CTRL D
1005	\$E	CTRL E
1006	\$F	CTRL F
1007	\$G	CTRL G
1008	\$H	CTRL H/ BACKSPACE ^a
1009	\$I	CTRL I/ HORIZONTAL TAB ¹

The Keystroke in bold is sent only if *Function Key Mapping on page 5-13* is enabled. Otherwise, the unbolded keystroke is sent.

Table 5-2 Keyboard Wedge ASCII Character Set (Continued)

ASCII Value	Full ASCII Code 39 Encode Char.	Keystroke
1010	\$J	CTRL J
1011	\$K	CTRL K
1012	\$L	CTRL L
1013	\$M	CTRL M/ ENTER ¹
1014	\$N	CTRL N
1015	\$O	CTRL O
1016	\$P	CTRL P
1017	\$Q	CTRL Q
1018	\$R	CTRL R
1019	\$S	CTRL S
1020	\$T	CTRL T
1021	\$U	CTRL U
1022	\$V	CTRL V
1023	\$W	CTRL W
1024	\$X	CTRL X
1025	\$Y	CTRL Y
1026	\$Z	CTRL Z
1027	%A	NONE/ ESC ¹
1028	%B	NONE
1029	%C	NONE
1030	%D	NONE
1031	%E	NONE
1032	Space	Space
1033	/A	!
1034	/B	"
1035	/C	#
1036	/D	\$
1037	/E	%

The Keystroke in bold is sent only if [Function Key Mapping on page 5-13](#) is enabled. Otherwise, the unbolded keystroke is sent.

Table 5-2 Keyboard Wedge ASCII Character Set (Continued)

ASCII Value	Full ASCII Code 39 Encode Char.	Keystroke
1038	/F	&
1039	/G	'
1040	/H	(
1041	/I)
1042	/J	*
1043	/K	+
1044	/L	,
1045	-	-
1046	.	.
1047	/O	/
1048	0	0
1049	1	1
1050	2	2
1051	3	3
1052	4	4
1053	5	5
1054	6	6
1055	7	7
1056	8	8
1057	9	9
1058	/Z	:
1059	%F	;
1060	%G	<
1061	%H	=
1062	%I	>
1063	%J	?
1064	%V	@
1065	A	A

The Keystroke in bold is sent only if *Function Key Mapping on page 5-13* is enabled. Otherwise, the unbolded keystroke is sent.

Table 5-2 Keyboard Wedge ASCII Character Set (Continued)

ASCII Value	Full ASCII Code 39 Encode Char.	Keystroke
1066	B	B
1067	C	C
1068	D	D
1069	E	E
1070	F	F
1071	G	G
1072	H	H
1073	I	I
1074	J	J
1075	K	K
1076	L	L
1077	M	M
1078	N	N
1079	O	O
1080	P	P
1081	Q	Q
1082	R	R
1083	S	S
1084	T	T
1085	U	U
1086	V	V
1087	W	W
1088	X	X
1089	Y	Y
1090	Z	Z
1091	%K	[
1092	%L	\
1093	%M]

The Keystroke in bold is sent only if *Function Key Mapping on page 5-13* is enabled. Otherwise, the unbolded keystroke is sent.

Table 5-2 Keyboard Wedge ASCII Character Set (Continued)

ASCII Value	Full ASCII Code 39 Encode Char.	Keystroke
1094	%N	^
1095	%O	_
1096	%W	'
1097	+A	a
1098	+B	b
1099	+C	c
1100	+D	d
1101	+E	e
1102	+F	f
1103	+G	g
1104	+H	h
1105	+I	i
1106	+J	j
1107	+K	k
1108	+L	l
1109	+M	m
1110	+N	n
1111	+O	o
1112	+P	p
1113	+Q	q
1114	+R	r
1115	+S	s
1116	+T	t
1117	+U	u
1118	+V	v
1119	+W	w
1120	+X	x
1121	+Y	y

The Keystroke in bold is sent only if *Function Key Mapping on page 5-13* is enabled. Otherwise, the unbolded keystroke is sent.

Table 5-2 Keyboard Wedge ASCII Character Set (Continued)

ASCII Value	Full ASCII Code 39 Encode Char.	Keystroke
1122	+Z	z
1123	%P	{
1124	%Q	
1125	%R	}
1126	%S	~
ALT Keys	Keystroke	
2065	ALT A	A
2066	ALT B	B
2067	ALT C	C
2068	ALT D	D
2069	ALT E	E
2070	ALT F	F
2071	ALT G	G
2072	ALT H	H
2073	ALT I	I
2074	ALT J	J
2075	ALT K	K
2076	ALT L	L
2077	ALT M	M
2078	ALT N	N
2079	ALT O	O
2080	ALT P	P
2081	ALT Q	Q
2082	ALT R	R
2083	ALT S	S
2084	ALT T	T
2085	ALT U	U
2086	ALT V	V

The Keystroke in bold is sent only if [Function Key Mapping on page 5-13](#) is enabled. Otherwise, the unbolded keystroke is sent.

Table 5-2 Keyboard Wedge ASCII Character Set (Continued)

ASCII Value	Full ASCII Code 39 Encode Char.	Keystroke
2087	ALT W	
2088	ALT X	
2089	ALT Y	
2090	ALT Z	

GUI Shift Keys

The Apple™ iMac keyboard has an apple key on either side of the space bar. Windows-based systems have a GUI key to the left of the left ALT key, and to the right of the right ALT key.

Other Value	Keystroke
3000	Right Control Key
3048	GUI 0
3049	GUI 1
3050	GUI 2
3051	GUI 3
3052	GUI 4
3053	GUI 5
3054	GUI 6
3055	GUI 7
3056	GUI 8
3057	GUI 9
3065	GUI A
3066	GUI B
3067	GUI C
3068	GUI D
3069	GUI E
3070	GUI F
3071	GUI G
3072	GUI H
3073	GUI I
3074	GUI J

The Keystroke in bold is sent only if *Function Key Mapping on page 5-13* is enabled. Otherwise, the unbolded keystroke is sent.

Table 5-2 Keyboard Wedge ASCII Character Set (Continued)

ASCII Value	Full ASCII Code 39 Encode Char.	Keystroke
3075		GUI K
3076		GUI L
3077		GUI M
3078		GUI N
3079		GUI O
3080		GUI P
3081		GUI Q
3082		GUI R
3083		GUI S
3084		GUI T
3085		GUI U
3086		GUI V
3087		GUI W
3088		GUI X
3089		GUI Y
3090		GUI Z
F Keys		Keystroke
5001		F1
5002		F2
5003		F3
5004		F4
5005		F5
5006		F6
5007		F7
5008		F8
5009		F9
5010		F10
5011		F11

The Keystroke in bold is sent only if *Function Key Mapping on page 5-13* is enabled. Otherwise, the unbolded keystroke is sent.

Table 5-2 Keyboard Wedge ASCII Character Set (Continued)

ASCII Value	Full ASCII Code 39 Encode Char.	Keystroke
5012	F12	
5013	F13	
5014	F14	
5015	F15	
5016	F16	
5017	F17	
5018	F18	
5019	F19	
5020	F20	
5021	F21	
5022	F22	
5023	F23	
5024	F24	
Numeric Keypad	Keystroke	
6042	*	
6043	+	
6044	undefined	
6045	-	
6046	.	
6047	/	
6048	0	
6049	1	
6050	2	
6051	3	
6052	4	
6053	5	
6054	6	
6055	7	

The Keystroke in bold is sent only if *Function Key Mapping on page 5-13* is enabled. Otherwise, the unbolded keystroke is sent.

Table 5-2 Keyboard Wedge ASCII Character Set (Continued)

ASCII Value	Full ASCII Code 39 Encode Char.	Keystroke
6056	8	
6057	9	
6058	Enter	
6059	Num Lock	
Extended Keypad	Keystroke	
7001	Break	
7002	Delete	
7003	Pg Up	
7004	End	
7005	Pg Dn	
7006	Pause	
7007	Scroll Lock	
7008	Backspace	
7009	Tab	
7010	Print Screen	
7011	Insert	
7012	Home	
7013	Enter	
7014	Escape	
7015	Up Arrow	
7016	Dn Arrow	
7017	Left Arrow	
7018	Right Arrow	

The Keystroke in bold is sent only if *Function Key Mapping on page 5-13* is enabled. Otherwise, the unbolded keystroke is sent.

a.

Chapter 6 RS-232 Interface

Introduction

This chapter provides RS-232 host information for setting up a scanner. The RS-232 interface connects the scanner to point-of-sale devices, host computers, or other devices with an available RS-232 port (e.g., com port).

- ✓ **NOTE** This scanner uses TTL RS-232 signal levels, which interfaces with most system architectures. For system architectures requiring RS-232C signal levels, Motorola offers different cables providing the TTL to RS-232C conversion. Contact Motorola Enterprise Mobility Support for more information.

If your host does not appear in [Table 6-2](#), set the communication parameters to match the host. Refer to the documentation for the host.

Throughout the programming bar code menus, asterisks (*) indicate default values.



* Indicates Default *Baud Rate 9600 Feature/Option

Connecting an RS-232 Interface

Connect the scanner directly to the host computer.

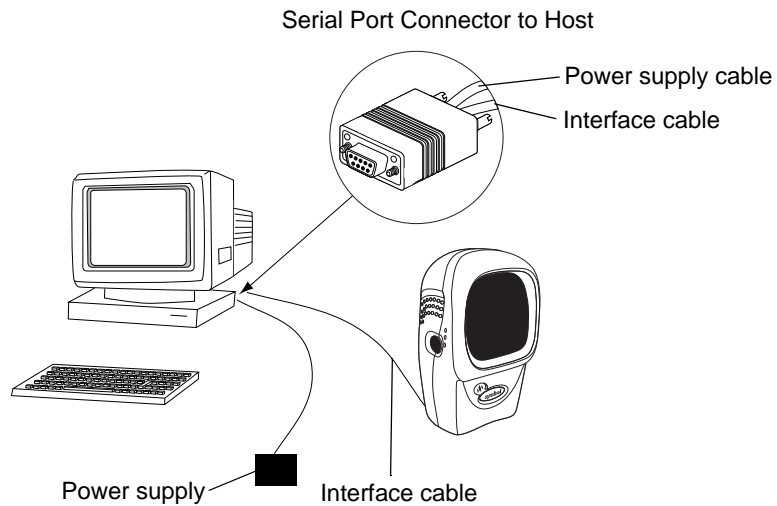

Figure 6-1 RS-232 Direct Connection

1. Connect the RS-232 interface cable to the rear of the scanner, as described in [Installing the Interface Cable on page 1-2](#).
2. Connect the other end of the interface cable to the serial port on the host.
3. Connect the power supply.
4. Scan appropriate bar codes in this chapter to match host settings.

RS-232 Default Parameters

[Table 6-1](#) lists the defaults for RS-232 host parameters. If you wish to change any option, scan the appropriate bar code(s) provided in the Parameter Descriptions section beginning on [page 6-4](#).

✓ **NOTE** See [Appendix A, Standard Default Parameters](#) for all user preferences, hosts, symbologies, and miscellaneous default parameters.

Table 6-1 RS-232 Host Default Table

Parameter	Default	Page Number
RS-232 Host Parameters		
RS-232 Host Types	Standard ¹	6-6
Baud Rate	9600	6-8
Parity	None	6-10
Check Receive Errors	Enable	6-11
Hardware Handshaking	None	6-12
Software Handshaking	None	6-14
Host Serial Response Time-out	2 Sec	6-15
RTS Line State	Low RTS	6-17
Stop Bit Select	1	6-17
Data Bits	8-Bit	6-18
Beep on <BEL>	Disable	6-18
Intercharacter Delay	0 msec	6-19
Nixdorf Beep/LED Option	Normal Operation	6-20
Ignore Unknown Characters	Send Bar Codes	6-21

¹User selection is required to configure this interface and this is the most common selection.

RS-232 Host Parameters

Various RS-232 hosts use their own parameter default settings ([Table 6-2](#)). Selecting the ICL, Fujitsu, Wincor-Nixdorf Mode A, Wincor-Nixdorf Mode B, Olivetti, Omron, or terminal sets the defaults listed in [Table 6-2](#).

Table 6-2 Terminal Specific RS-232

Parameter	Standard (Default)	ICL	Fujitsu	Wincor-Nixdorf Mode A	Wincor-Nixdorf Mode B/OPOS	Olivetti	Omron
Transmit Code ID	No	Yes	Yes	Yes	Yes	Yes	Yes
Data Transmission Format	Data as is	Data/Suffix	Data/Suffix	Data/Suffix	Data/Suffix	Prefix/Data/Suffix	Data/Suffix
Suffix	CR/LF (7013)	CR (1013)	CR (1013)	CR (1013)	CR (1013)	ETX (1002)	CR (1013)
Baud Rate	9600	9600	9600	9600	9600	9600	9600
Parity	None	Even	None	Odd	Odd	Even	None
Hardware Handshaking	None	RTS/CTS Option 3	None	RTS/CTS Option 3	RTS/CTS Option 3	None	None
Software Handshaking	None	None	None	None	None	Ack/Nak	None
Serial Response Time-out	2 Sec.	9.9 Sec.	2 Sec.	9.9 Sec.	9.9 Sec.	9.9 Sec.	9.9 Sec.
Stop Bit Select	One	One	One	One	One	One	One
ASCII Format	8-Bit	8-Bit	8-Bit	8-Bit	8-Bit	7-Bit	8-Bit
Beep On <BEL>	Disable	Disable	Disable	Disable	Disable	Disable	Disable
RTS Line State	Low	High	Low	Low	Low = No data to send	Low	High
Prefix	None	None	None	None	None	STX (1003)	None

***In the Nixdorf Mode B, if CTS is low, scanning is disabled. When CTS is high, scanning is enabled.**
****If you select Nixdorf Mode B without connecting the scanner to the proper host, the scanner may appear unable to scan. In this case, scan a different RS-232 host type within 5 seconds of cycling power to the scanner.**

RS-232 Host Types

To select an RS-232 host interface, scan one of the following bar codes.



Standard RS-232¹



ICL RS-232



Wincor-Nixdorf RS-232 Mode A



Wincor-Nixdorf RS-232 Mode B

✓ **NOTE** ¹User selection is required to configure this interface and this is the most common selection.

RS-232 Host Types (continued)



Fujitsu RS-232

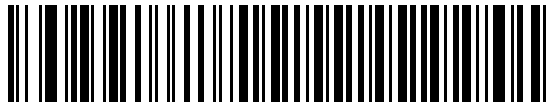

Olivetti ORS4500

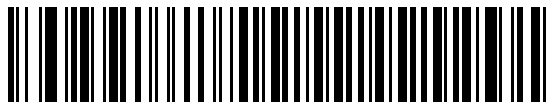

Omron



OPOS/JPOS

Baud Rate

Baud rate is the number of bits of data transmitted per second. Set the scanner's baud rate to match the host's baud rate setting. Otherwise data may not reach the host device or may reach it in distorted form.



Baud Rate 600

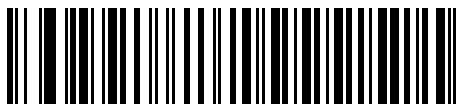

Baud Rate 1200

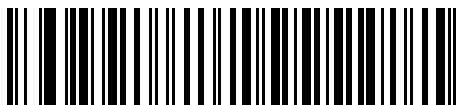

Baud Rate 2400

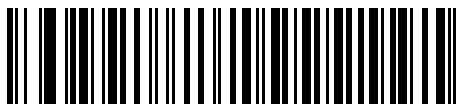

Baud Rate 4800

Baud Rate (continued)

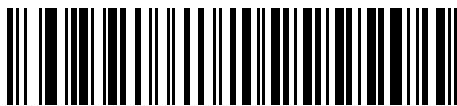

***Baud Rate 9600**

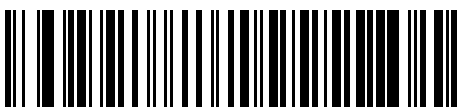

Baud Rate 19,200

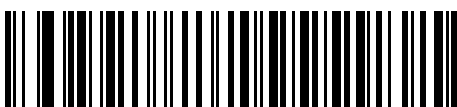

Baud Rate 38,400

Parity

A parity check bit is the most significant bit of each ASCII coded character. Select the parity type according to host device requirements.

Select **Odd** parity to set the parity bit value to 0 or 1, based on data, to ensure that the coded character contains an odd number of 1 bits.

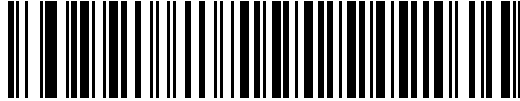

Odd

Select **Even** parity to set the parity bit value to 0 or 1, based on data, to ensure that the coded character contains an even number of 1 bits.



Even

Select **Mark** parity and the parity bit is always 1.

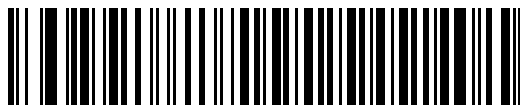

Mark

Select **Space** parity and the parity bit is always 0.



Space

Parity (continued)

Select **None** when no parity bit is required.



***None**

Check Receive Errors

Select whether or not to check the parity, framing, and overrun of received characters. The parity value of received characters is verified against the *Parity* setting.

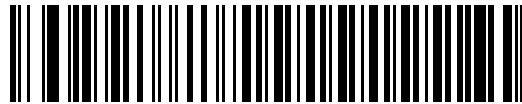

***Check For Received Errors**



Do Not Check For Received Errors

Hardware Handshaking

The data interface consists of an RS-232 port designed to operate either with or without the hardware handshaking lines *Request to Send (RTS)* and *Clear to Send (CTS)*.

If **Standard RTS/CTS** handshaking is not selected, scan data transmits as it becomes available. Select **Standard RTS/CTS** handshaking to transmit scan data according to the following sequence:

- The scanner reads the CTS line for activity. If CTS is asserted, the scanner waits up to 2 seconds for the host to negate the CTS line. If, after 2 seconds (default), the CTS line is still asserted, the scanner sounds a transmit error, and any scanned data is lost.
- When the CTS line is negated, the scanner asserts the RTS line and waits up to 2 seconds for the host to assert CTS. When the host asserts CTS, data is transmitted. If, after 2 seconds (default), the CTS line is not asserted, the scanner sounds a transmit error, and discards the data.
- When data transmission completes, the scanner negates RTS 10 msec after sending the last character.
- The host responds by negating CTS. The scanner checks for a negated CTS upon the next data transmission.

During data transmission, the CTS line should be asserted. If CTS is deasserted for more than 50 ms between characters, the transmission aborts, the scanner sounds a transmission error and discards the data.

If this communications sequence fails, the scanner issues an error indication. In this case, the data is lost and must be rescanned.

If hardware handshaking and software handshaking are both enabled, hardware handshaking takes precedence.



NOTE The DTR signal is jumpered to the active state.

None

Scan this bar code to disable hardware handshaking.

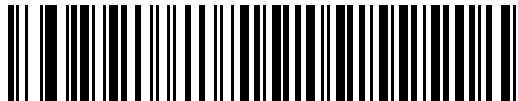

*None

Standard RTS/CTS

Scan this bar code to select Standard RTS/CTS Hardware Handshaking.

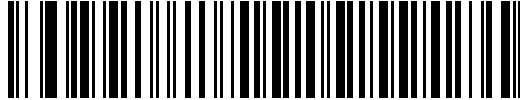

Standard RTS/CTS

RTS/CTS Option 1

The scanner asserts RTS before transmitting and ignores the state of CTS. The scanner de-asserts RTS when the transmission completes.



RTS/CTS Option 1

RTS/CTS Option 2

RTS is always high or low (user-programmed logic level). However, the scanner waits for CTS to be asserted before transmitting data. If CTS is not asserted within 2 seconds (default), the scanner issues an error indication and discards the data.



RTS/CTS Option 2

RTS/CTS Option 3

The scanner asserts RTS prior to any data transmission, regardless of the state of CTS. The scanner waits up to 2 seconds (default) for CTS to be asserted. If CTS is not asserted during this time, the scanner issues an error indication and discards the data. The scanner de-asserts RTS when transmission completes.



RTS/CTS Option 3

Software Handshaking

This parameter offers control of data transmission in addition to, or instead of, the control that hardware handshaking offers. There are five options.

If software handshaking and hardware handshaking are both enabled, hardware handshaking takes precedence.

None

Select this option to transmit data immediately.

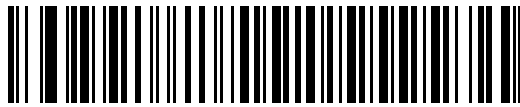

*None

ACK/NAK

After transmitting data, the scanner expects either an ACK or NAK response from the host. When it receives a NAK, the scanner transmits the same data again and waits for either an ACK or NAK. After three unsuccessful attempts to send data after receiving NAKs, the scanner issues an error indication and discards the data.

The scanner waits up to the programmable *Host Serial Response Time-out* to receive an ACK or NAK. If the scanner does not receive a response in this time, it issues an error indication and discards the data. There are no retries when a time-out occurs.



ACK/NAK

ENQ

The scanner waits for an ENQ character from the host before transmitting data. If the scanner does not receive an ENQ within the *Host Serial Response Time-out*, it issues an error indication and discards the data. The host must transmit an ENQ character at least every *Host Serial Response Time-out* to prevent transmission errors.



ENQ

ACK/NAK with ENQ

This combines the two previous options.

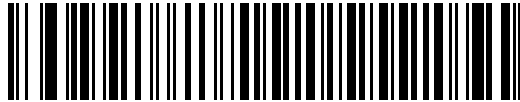

ACK/NAK with ENQ

XON/XOFF

An XOFF character turns the scanner transmission off until the scanner receives an XON character. There are two situations for XON/XOFF:

- The scanner receives an XOFF before it has data to send. When the scanner has data to send, it waits up to 2 seconds for an XON character before transmission. If it does not receive the XON within this time, the scanner issues an error indication and discards the data.
- The scanner receives an XOFF during a transmission. The scanner stops data transmission after sending the current byte. When it receives an XON character, it sends the rest of the data message. The scanner waits indefinitely for the XON.



XON/XOFF

Host Serial Response Time-out

This parameter specifies how long the scanner waits for an ACK, NAK, or CTS before determining that a transmission error occurred. This only applies when in one of the ACK/NAK software handshaking modes, or in RTS/CTS hardware handshaking mode.



***Minimum: 2 Sec**



Low: 2.5 Sec

Host Serial Response Time-out (continued)



Medium: 5 Sec



High: 7.5 Sec



Maximum: 9.9 Sec

RTS Line State

This parameter sets the idle state of the Serial Host RTS line. Scan a bar code below to select **Low RTS** or **High RTS** line state.



***Host: Low RTS**



Host: High RTS

Stop Bit Select

The stop bit(s) at the end of each transmitted character marks the end of transmission of one character and prepares the receiving device for the next character in the serial data stream. Select the number of stop bits (one or two) to match the number the receiving host is programmed to accommodate.

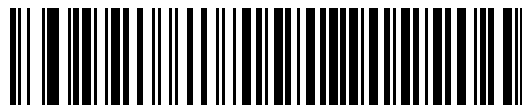

***1 Stop Bit**



2 Stop Bits

Data Bits

This parameter allows the scanner to interface with devices requiring a 7-bit or 8-bit ASCII protocol.



7-Bit

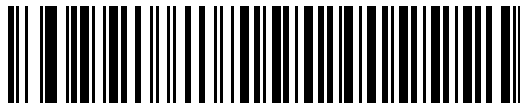

*8-Bit

Beep on <BEL>

If you enable this parameter, the scanner issues a beep when it detects a <BEL> character on the RS-232 serial line. <BEL> gains a user's attention to an illegal entry or other important event.



Beep On <BEL> Character
(Enable)

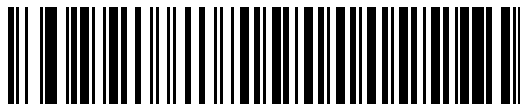

*Do Not Beep On <BEL> Character
(Disable)

Intercharacter Delay

This parameter specifies the intercharacter delay inserted between character transmissions.



***Minimum: 0 msec**

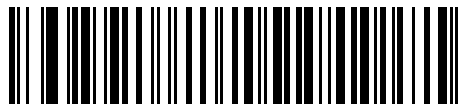

Low: 25 msec

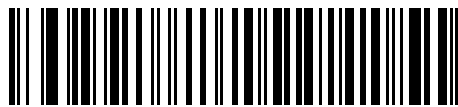

Medium: 50 msec

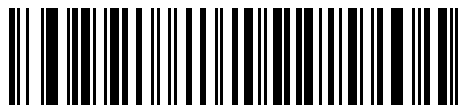

High: 75 msec

Intercharacter Delay (continued)

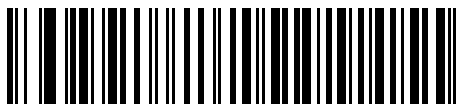

Maximum: 99 msec

Nixdorf Beep/LED Options

After selecting Nixdorf Mode B, this parameter indicates when the scanner beeps and turns on its LED after a decode.

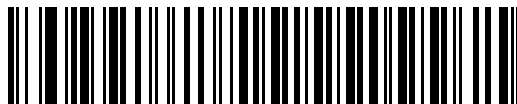

***Normal Operation**
(Beep/LED immediately after decode)

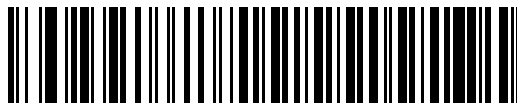

Beep/LED After Transmission

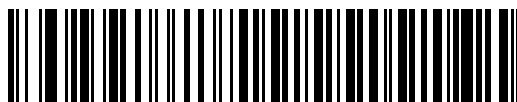

Beep/LED After CTS Pulse

Ignore Unknown Characters

Unknown characters are characters the host does not recognize.

Select **Send Bar Codes With Unknown Characters** to send all bar code data except for unknown characters. The scanner issues no error beeps.

Select **Do Not Send Bar Codes With Unknown Characters** to send bar code data up to the first unknown character. The scanner issues an error beep.

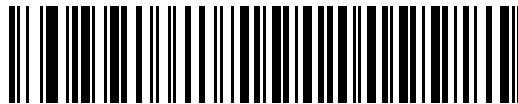

***Send Bar Code
(With Unknown Characters)**

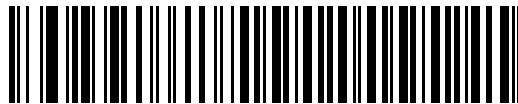

**Do Not Send Bar Codes
(With Unknown Characters)**

ASCII / Character Set

Assign the values in [Table 6-4](#) as prefixes or suffixes for ASCII character data transmission.

Table 6-4 ASCII Character Set

ASCII Value	Full ASCII Code 39 Encode Character	ASCII Character
1000	%U	NUL
1001	\$A	SOH
1002	\$B	STX
1003	\$C	ETX
1004	\$D	EOT
1005	\$E	ENQ
1006	\$F	ACK
1007	\$G	BELL
1008	\$H	BCKSPC
1009	\$I	HORIZ TAB
1010	\$J	LF/NW LN
1011	\$K	VT
1012	\$L	FF
1013	\$M	CR/ENTER
1014	\$N	SO
1015	\$O	SI
1016	\$P	DLE
1017	\$Q	DC1
1018	\$R	DC2
1019	\$S	DC3
1020	\$T	DC4
1021	\$U	NAK
1022	\$V	SYN
1023	\$W	ETB
1024	\$X	CAN
1025	\$Y	EM
1026	\$Z	SUB

Table 6-4 ASCII Character Set (Continued)

ASCII Value	Full ASCII Code 39 Encode Character	ASCII Character
1027	%A	ESC
1028	%B	FS
1029	%C	GS
1030	%D	RS
1031	%E	US
1032	Space	Space
1033	/A	!
1034	/B	"
1035	/C	#
1036	/D	\$
1037	/E	%
1038	/F	&
1039	/G	'
1040	/H	(
1041	/I)
1042	/J	*
1043	/K	+
1044	/L	,
1045	-	-
1046	.	.
1047	/O	/
1048	0	0
1049	1	1
1050	2	2
1051	3	3
1052	4	4
1053	5	5
1054	6	6
1057	7	7
1056	8	8

Table 6-4 ASCII Character Set (Continued)

ASCII Value	Full ASCII Code 39 Encode Character	ASCII Character
1057	9	9
1058	/Z	:
1059	%F	;
1060	%G	<
1061	%H	=
1062	%I	>
1063	%J	?
1064	%V	@
1065	A	A
1066	B	B
1067	C	C
1068	D	D
1069	E	E
1070	F	F
1071	G	G
1072	H	H
1073	I	I
1074	J	J
1075	K	K
1076	L	L
1077	M	M
1078	N	N
1079	O	O
1080	P	P
1081	Q	Q
1082	R	R
1083	S	S
1084	T	T
1085	U	U
1086	V	V

Table 6-4 ASCII Character Set (Continued)

ASCII Value	Full ASCII Code 39 Encode Character	ASCII Character
1087	W	W
1088	X	X
1089	Y	Y
1090	Z	Z
1091	%K	[
1092	%L	\
1093	%M]
1094	%N	^
1095	%O	_
1096	%W	`
1097	+A	a
1098	+B	b
1099	+C	c
1100	+D	d
1101	+E	e
1102	+F	f
1103	+G	g
1104	+H	h
1105	+I	i
1106	+J	j
1107	+K	k
1108	+L	l
1109	+M	m
1110	+N	n
1111	+O	o
1112	+P	p
1113	+Q	q
1114	+R	r
1115	+S	s
1116	+T	t

Table 6-4 ASCII Character Set (Continued)

ASCII Value	Full ASCII Code 39 Encode Character	ASCII Character
1117	+U	u
1118	+V	v
1119	+W	w
1120	+X	x
1121	+Y	y
1122	+Z	z
1123	%P	{
1124	%Q	
1125	%R	}
1126	%S	~
1127		Undefined
7013		ENTER

Chapter 7 USB Interface

Introduction

This chapter provides information for connecting the scanner to a USB host. The scanner attaches directly to a USB host, or a powered USB hub, which powers it. The scanner does not require an additional power supply.

Throughout the programming bar code menus, asterisks (*) indicate default values.



Connecting a USB Interface

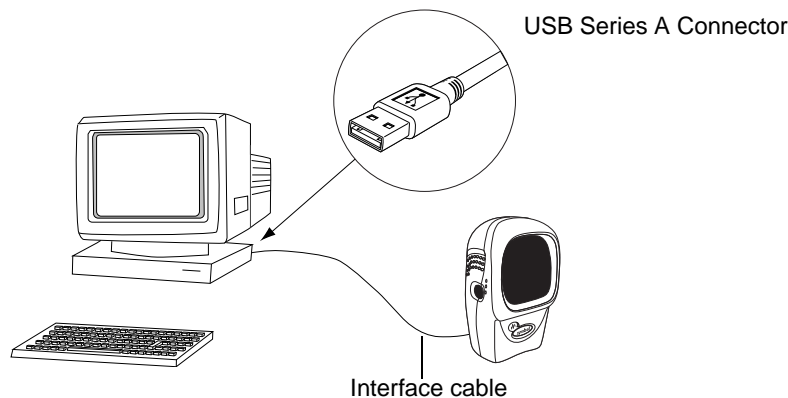

Figure 7-1 *USB Connection*

The scanner connects with USB capable hosts including:

- Desktop PCs and Notebooks
- Apple™ iMac, G4, iBooks (North America only)
- IBM SurePOS terminals
- Sun, IBM, and other network computers that support more than one keyboard.

The following operating systems support the scanner through USB:

- Windows 98, 2000, ME, XP
- MacOS 8.5 and above
- IBM 4690 OS.

The scanner also interfaces with other USB hosts which support USB Human Interface Devices (HID).

To set up your scanner:

1. Connect the USB interface cable to the rear of the scanner, as described in [Installing the Interface Cable on page 1-2](#).
2. Plug the series A connector in the USB host or hub, or plug the Plus Power connector in an available port of the IBM SurePOS terminal.
3. Select the USB device type. See [USB Device Type on page 7-4](#).
4. On first installation when using Windows, the software prompts you to select or install the **Human Interface Device** driver. To install this driver, provided by Windows, click **Next** through all the choices and click **Finished** on the last choice. The scanner powers up during this installation.
5. If you are not using a North American keyboard, scan the appropriate country bar code under [USB Country Keyboard Types \(Country Codes\) on page 7-6](#).

If you are having any problems with the system, see [Troubleshooting on page 3-2](#).

USB Default Parameters

[Table 7-1](#) lists the defaults for USB host parameters. To change any option, scan the appropriate bar code(s) provided in the Parameter Descriptions section beginning on [page 7-4](#).

✓ **NOTE** See [Appendix A, Standard Default Parameters](#) for all user preferences, hosts, symbologies, and miscellaneous default parameters.

Table 7-1 USB Host Default Table

Parameter	Default	Page Number
USB Host Parameters		
USB Device Type	HID (Human Interface Device) Keyboard Emulation	7-4
USB Country Keyboard Types (Country Codes)	North American	7-6
USB Keystroke Delay	No Delay	7-9
USB CAPS Lock Override	Disable	7-10
USB Ignore Unknown Characters	Send Bar Codes	7-10
Emulate Keypad	Disable	7-11
USB Keyboard FN1 Substitution	Disable	7-11
Function Key Mapping	Disable	7-12
Simulated Caps Lock	Disable	7-12
Convert Case	Disable	7-13

USB Host Parameters

USB Device Type

Select the USB device type.

- **HID Keyboard Emulation** (default) - The scanner emulates a USB keyboard. Upon a successful decode, the scanner transmits bar code data to the console as if the data was typed on a keyboard. Most USB drivers support **HID Keyboard Emulation** so no special drivers are required.
- **IBM Table Top USB** - Use this to connect table top scanners to a cash register with IBM OEM specification compliant drivers (supplied by the cash register vendor). The Point-of-Service (POS) device vendor provides the required IBM Table Top USB drivers. Check with the POS vendor to verify these drivers.
- **IBM Hand-Held USB** - Use this to connect hand-held scanners to a cash register with IBM OEM specification compliant drivers (supplied by the cash register vendor). The Point-of-Service (POS) device vendor provides the required IBM Hand-Held USB drivers. Check with the POS vendor to verify these drivers.

✓ **NOTE** When connecting two scanners to a host, IBM does not permit selecting two of the same device types. If you require two connections, select IBM Table Top USB for one scanner and IBM Hand-Held USB for the second scanner.

- **USB OPOS Hand-Held** - Use this with Symbol's OPOS/JPOS compliant drivers, available from Motorola Enterprise Mobility Support at www.motorolasolutions.com/support. Motorola only supports one OPOS connection per host.
- **Simple COM Port Emulation** - Download a Motorola driver from Motorola Enterprise Mobility Support at www.motorolasolutions.com/support. Connecting the scanner to the host automatically selects the next available com port, emulating a one-way RS-232 connection. This does not support handshaking, and requires no baud settings.

✓ **NOTE** When changing USB Device Types, the scanner automatically restarts. The scanner issues the standard startup beep sequences.

USB Device Type (continued)



***HID Keyboard Emulation**

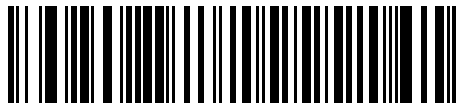

IBM Table Top USB



IBM Hand-Held USB



USB OPOS Hand-Held



Simple COM Port Emulation

USB Country Keyboard Types (Country Codes)

Scan the bar code corresponding to your keyboard type. This setting applies only to the USB HID Keyboard Emulation device.

- ✓ **NOTE** When changing Country Selection, the scanner automatically restarts. The scanner issues the standard startup beep sequences.



*North American, Standard USB Keyboard

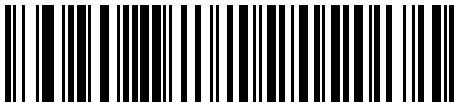

French, Windows

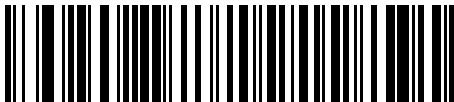

German, Windows

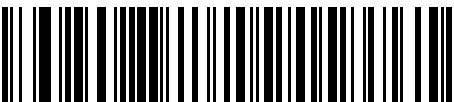

French Canadian, Windows

USB Country Keyboard Types (Continued)



French Canadian, Windows 2000/XP



French Belgian Windows

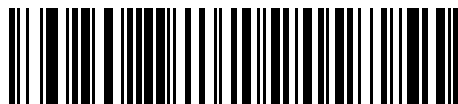

Spanish (Traditional), Windows

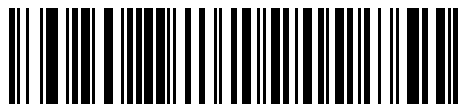

Italian, Windows

USB Country Keyboard Types (Continued)



Swedish, Windows



UK English, Windows



Japanese, Windows (ASCII)



Portuguese-Brazilian, Windows

USB Keystroke Delay

This parameter sets the delay, in milliseconds, between emulated keystrokes. Scan a bar code below to increase the delay when hosts require slower data transmission.

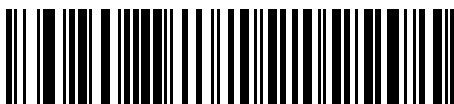

***No Delay**

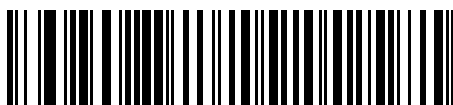

Medium Delay (20 msec)

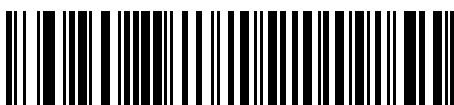

Long Delay (40 msec)

USB CAPS Lock Override

This option applies only to the HID Keyboard Emulation device. Enable this to preserve the case of the data regardless of the state of the caps lock key. This setting is always enabled for the “Japanese, Windows (ASCII)” keyboard type and can not be disabled.



Override Caps Lock Key
(Enable)

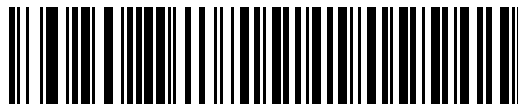

*Do Not Override Caps Lock Key
(Disable)

USB Ignore Unknown Characters

This option applies only to the HID Keyboard Emulation device and IBM device. Unknown characters are characters the host does not recognize. Select **Send Bar Codes With Unknown Characters** to send all bar code data except for unknown characters. No error beeps sound. If you select **Do Not Send Bar Codes With Unknown Characters**, bar codes containing at least one unknown character are not sent to the host, and an error beep sounds.

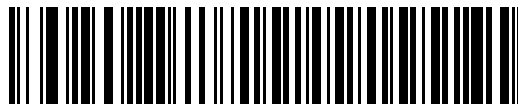

*Send Bar Codes With Unknown Characters

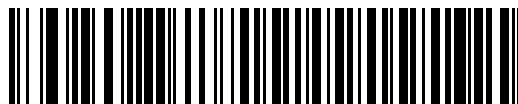

Do Not Send Bar Codes With Unknown Characters
(Disable)

Emulate Keypad

Enable this to send all characters as ASCII sequences over the numeric keypad. For example ASCII A transmits as "ALT make" 0 6 5 "ALT Break".



***Disable Keypad Emulation**

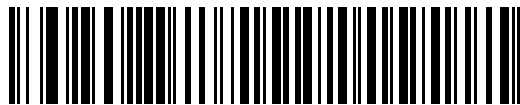

Enable Keypad Emulation

USB Keyboard FN1 Substitution

This option applies only to the USB HID Keyboard Emulation device. Enable this to replace any FN1 characters in an EAN 128 bar code with a user-selected Key Category and value (see [FN1 Substitution Values on page 12-5](#) to set the Key Category and Key Value).

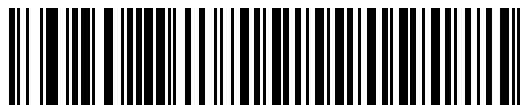

Enable

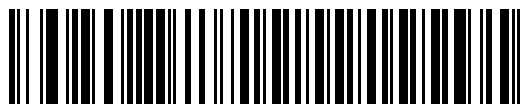

***Disable**

Function Key Mapping

ASCII values under 32 normally transmit as a control-key sequences (see [Table 7-2 on page 7-14](#)). Enable this parameter to send the keys in bold in place of the standard key mapping. Table entries that do not have a bold entry remain the same whether or not you enable this parameter.

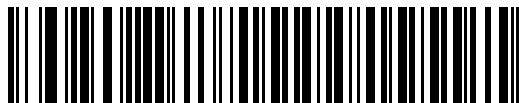

***Disable Function Key Mapping**

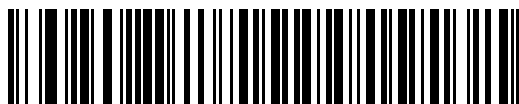

Enable Function Key Mapping

Simulated Caps Lock

Enable this to invert upper and lower case characters on the bar code as if the Caps Lock state is enabled on the keyboard. This inversion occurs regardless of the keyboard's current Caps Lock state.

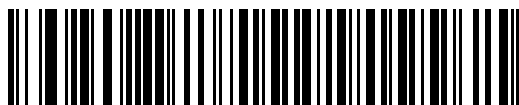

***Disable Simulated Caps Lock**

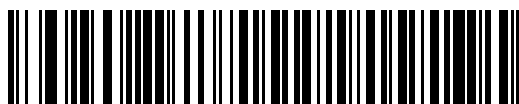

Enable Simulated Caps Lock

Convert Case

When enabled, the scanner converts all bar code data to the selected case.

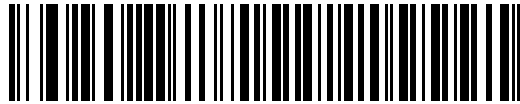

***No Case Conversion**

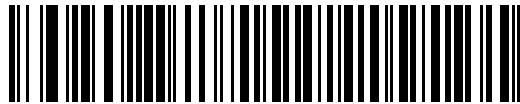

Convert All to Upper Case

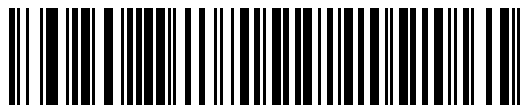

Convert All to Lower Case

ASCII Character Set

Table 7-2 USB ASCII Character Set

ASCII Value	Full ASCII Code 39 Encode Char.	Keystroke
1001	\$A	CTRL A
1002	\$B	CTRL B
1003	\$C	CTRL C
1004	\$D	CTRL D
1005	\$E	CTRL E
1006	\$F	CTRL F
1007	\$G	CTRL G
1008	\$H	CTRL H/ BACKSPACE ^a
1009	\$I	CTRL I/ HORIZONTAL TAB ^a
1010	\$J	CTRL J
1011	\$K	CTRL K
1012	\$L	CTRL L
1013	\$M	CTRL M/ ENTER ^a
1014	\$N	CTRL N
1015	\$O	CTRL O
1016	\$P	CTRL P
1017	\$Q	CTRL Q
1018	\$R	CTRL R
1019	\$S	CTRL S
1020	\$T	CTRL T
1021	\$U	CTRL U
1022	\$V	CTRL V
1023	\$W	CTRL W
1024	\$X	CTRL X
1025	\$Y	CTRL Y

The keystroke in bold is sent only if the [Function Key Mapping](#) on page 7-12 parameter is enabled. Otherwise, the unbolded keystroke is sent.

Table 7-2 USB ASCII Character Set (Continued)

ASCII Value	Full ASCII Code 39 Encode Char.	Keystroke
1026	\$Z	CTRL Z
1027	%A	NONE/ ESC ^a
1028	%B	NONE
1029	%C	NONE
1030	%D	NONE
1031	%E	NONE
1032	Space	Space
1033	/A	!
1034	/B	“
1035	/C	#
1036	/D	\$
1037	/E	%
1038	/F	&
1039	/G	‘
1040	/H	(
1041	/I)
1042	/J	*
1043	/K	+
1044	/L	,
1045	-	-
1046	.	.
1047	/O	/
1048	0	0
1049	1	1
1050	2	2
1051	3	3
1052	4	4
1053	5	5

The Keystroke in bold is sent only if the [Function Key Mapping on page 7-12](#) parameter is enabled. Otherwise, the unbolded keystroke is sent.

Table 7-2 USB ASCII Character Set (Continued)

ASCII Value	Full ASCII Code 39 Encode Char.	Keystroke
1054	6	6
1055	7	7
1056	8	8
1057	9	9
1058	/Z	:
1059	%F	;
1060	%G	<
1061	%H	=
1062	%I	>
1063	%J	?
1064	%V	@
1065	A	A
1066	B	B
1067	C	C
1068	D	D
1069	E	E
1070	F	F
1071	G	G
1072	H	H
1073	I	I
1074	J	J
1075	K	K
1076	L	L
1077	M	M
1078	N	N
1079	O	O
1080	P	P
1081	Q	Q

The Keystroke in bold is sent only if the [Function Key Mapping on page 7-12](#) parameter is enabled. Otherwise, the unbolded keystroke is sent.

Table 7-2 USB ASCII Character Set (Continued)

ASCII Value	Full ASCII Code 39 Encode Char.	Keystroke
1082	R	R
1083	S	S
1084	T	T
1085	U	U
1086	V	V
1087	W	W
1088	X	X
1089	Y	Y
1090	Z	Z
1091	%K	[
1092	%L	\
1093	%M]
1094	%N	^
1095	%O	_
1096	%W	`
1097	+A	a
1098	+B	b
1099	+C	c
1100	+D	d
1101	+E	e
1102	+F	f
1103	+G	g
1104	+H	h
1105	+I	i
1106	+J	j
1107	+K	k
1108	+L	l
1109	+M	m

The Keystroke in bold is sent only if the [Function Key Mapping on page 7-12](#) parameter is enabled. Otherwise, the unbolded keystroke is sent.

Table 7-2 USB ASCII Character Set (Continued)

ASCII Value	Full ASCII Code 39 Encode Char.	Keystroke
1110	+N	n
1111	+O	o
1112	+P	p
1113	+Q	q
1114	+R	r
1115	+S	s
1116	+T	t
1117	+U	u
1118	+V	v
1119	+W	w
1120	+X	x
1121	+Y	y
1122	+Z	z
1123	%P	{
1124	%Q	
1125	%R	}
1126	%S	~

The Keystroke in bold is sent only if the [Function Key Mapping on page 7-12](#) parameter is enabled. Otherwise, the unbolded keystroke is sent.

Table 7-2 USB ASCII Character Set (Continued)

ASCII Value	Full ASCII Code 39 Encode Char.	Keystroke
ALT Keys		Keystroke
2065		ALT A
2066		ALT B
2067		ALT C
2068		ALT D
2069		ALT E
2070		ALT F
2071		ALT G
2072		ALT H
2073		ALT I
2074		ALT J
2075		ALT K
2076		ALT L
2077		ALT M
2078		ALT N
2079		ALT O
2080		ALT P
2081		ALT Q
2082		ALT R
2083		ALT S
2084		ALT T
2085		ALT U
2086		ALT V
2087		ALT W
2088		ALT X
2089		ALT Y
2090		ALT Z

The Keystroke in bold is sent only if the *Function Key Mapping* on page 7-12 parameter is enabled. Otherwise, the unbolded keystroke is sent.

Table 7-2 USB ASCII Character Set (Continued)

ASCII Value	Full ASCII Code 39 Encode Char.	Keystroke
GUI Shift Keys		
The Apple™ iMac keyboard has an apple key on either side of the space bar. Windows-based systems have a GUI key to the left of the left ALT key, and to the right of the right ALT key.		
Other Value	Keystroke	
3000	Right Control Key	
3048	GUI 0	
3049	GUI 1	
3050	GUI 2	
3051	GUI 3	
3052	GUI 4	
3053	GUI 5	
3054	GUI 6	
3055	GUI 7	
3056	GUI 8	
3057	GUI 9	
3065	GUI A	
3066	GUI B	
3067	GUI C	
3068	GUI D	
3069	GUI E	
3070	GUI F	
3071	GUI G	
3072	GUI H	
3073	GUI I	
3074	GUI J	
3075	GUI K	
3076	GUI L	
3077	GUI M	
3078	GUI N	

The Keystroke in bold is sent only if the [Function Key Mapping on page 7-12](#) parameter is enabled. Otherwise, the unbolded keystroke is sent.

Table 7-2 USB ASCII Character Set (Continued)

ASCII Value	Full ASCII Code 39 Encode Char.	Keystroke
3079		GUI O
3080		GUI P
3081		GUI Q
3082		GUI R
3083		GUI S
3084		GUI T
3085		GUI U
3086		GUI V
3087		GUI W
3088		GUI X
3089		GUI Y
3090		GUI Z
F Keys		Keystroke
5001		F1
5002		F2
5003		F3
5004		F4
5005		F5
5006		F6
5007		F7
5008		F8
5009		F9
5010		F10
5011		F11
5012		F12
5013		F13
5014		F14
5015		F15

The Keystroke in bold is sent only if the [Function Key Mapping on page 7-12](#) parameter is enabled. Otherwise, the unbolded keystroke is sent.

Table 7-2 USB ASCII Character Set (Continued)

ASCII Value	Full ASCII Code 39 Encode Char.	Keystroke
5016	F16	
5017	F17	
5018	F18	
5019	F19	
5020	F20	
5021	F21	
5022	F22	
5023	F23	
5024	F24	
Numeric Keypad	Keystroke	
6042	*	
6043	+	
6045	-	
6046	.	
6047	/	
6048	0	
6049	1	
6050	2	
6051	3	
6052	4	
6053	5	
6054	6	
6055	7	
6056	8	
6057	9	
6058	Enter	
6059	Num Lock	

The Keystroke in bold is sent only if the *Function Key Mapping* on page 7-12 parameter is enabled. Otherwise, the unbolded keystroke is sent.

Table 7-2 USB ASCII Character Set (Continued)

ASCII Value	Full ASCII Code 39 Encode Char.	Keystroke
Extended Keypad		Keystroke
7001		Break
7002		Delete
7003		PgUp
7004		End
7005		Pg Dn
7006		Pause
7007		Scroll Lock
7008		Backspace
7009		Tab
7010		Print Screen
7011		Insert
7012		Home
7013		Enter
7014		Escape
7015		Up Arrow
7016		Down Arrow
7017		Left Arrow
7018		Right Arrow

The Keystroke in bold is sent only if the *Function Key Mapping on page 7-12* parameter is enabled. Otherwise, the unbolded keystroke is sent.

a.

Chapter 8 IBM 468X/469X Interface

Introduction

This chapter provides IBM 468X/469X host information for setting up the scanner.

Throughout the programming bar code menus, asterisks (*) indicate default values.

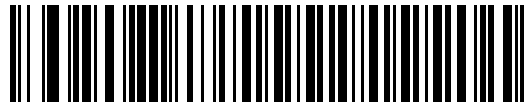

* Indicates Default — ***Disable Convert** — Feature/Option
Unknown to Code 39

Connecting to an IBM 468X/469X Host

The scanner connects directly to the host interface.

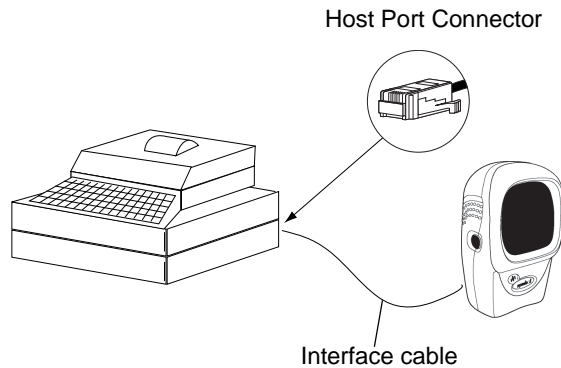

Figure 8-1 IBM Direct Connection

1. Connect the interface cable to the rear of the scanner, as described in [Installing the Interface Cable on page 1-2](#).
2. Connect the other end of the interface cable to the appropriate port on the host (typically, Port 9).
3. Scan the appropriate bar codes in this chapter to configure the scanner.

✓ **NOTE** The only required configuration is the port number. The IBM system typically controls most other scanner parameters.

IBM Default Parameters

[Table 8-1](#) lists the defaults for IBM host parameters. To change any option, scan the appropriate bar code(s) provided in the Parameter Descriptions section beginning on [page 8-3](#).

✓ **NOTE** See [Appendix A, Standard Default Parameters](#) for all user preferences, hosts, symbologies, and miscellaneous default parameters.

Table 8-1 IBM Host Default Table

Parameter	Default	Page Number
IBM 468X/469X Host Parameters		
Port Address	None Selected ¹	8-3
Convert Unknown to Code 39	Disable	8-4

¹User selection is required to configure this interface and this is the most common selection.

IBM 468X/469X Host Parameters

Port Address

This parameter sets the IBM 468X/469X port used.

✓ **NOTE** Scanning one of these bar codes enables the RS-485 interface on the scanner.

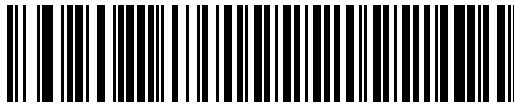

* None Selected



Hand-held Scanner Emulation (Port 9B)¹

✓ **NOTE** ¹User selection is required to configure this interface and this is the most common selection.

Port Address (Continued)



Non-IBM Scanner Emulation (Port 5B)

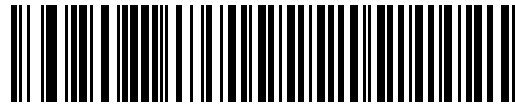

Table Top Scanner Emulation (Port 17)

Convert Unknown to Code 39

Scan a bar code below to enable or disable converting unknown bar code type data to Code 39.



Enable Convert Unknown to Code 39

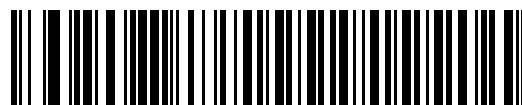

***Disable Convert Unknown to Code 39**

Chapter 9 Wand Emulation Interface

Introduction

This chapter provides Wand Emulation host information for setting up the scanner. Use this mode when you require Wand Emulation communication. The scanner connects either to an external wand decoder or to a decoder integrated in a portable terminal or Point-of-Sale (POS) terminal.

In this mode the scanner emulates the signal of a digital wand to make it "readable" by a wand decoder.

Throughout the programming bar code menus, asterisks (*) indicate default values.



Connecting Using Wand Emulation

To perform Wand Emulation, connect the scanner to a portable data terminal, or a controller which collects the wand data and interprets it for the host.

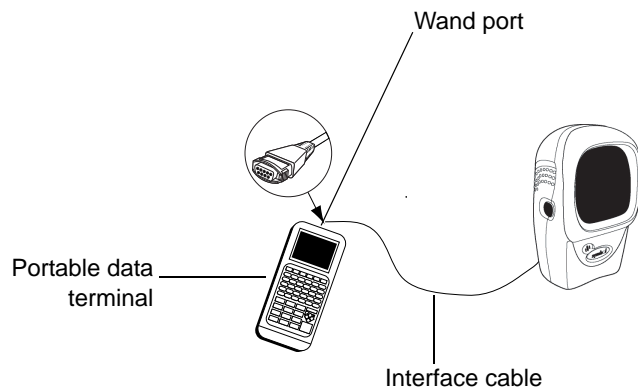

Figure 9-1 *Wand Emulation Connection*

1. Connect the Wand Emulation interface cable to the rear of the scanner, as described in [Installing the Interface Cable on page 1-2](#).
2. Connect the other end of the interface cable to the Wand port on the portable data terminal or controller.
3. Scan the appropriate bar codes in this chapter to configure the scanner.

Wand Emulation Default Parameters

Table 9-1 lists the defaults for Wand Emulation host types. To change any option, scan the appropriate bar code(s) provided in the Wand Emulation Host Parameters section beginning on page 9-4.

✓ **NOTE** See Appendix A, Standard Default Parameters for all user preferences, hosts, symbologies, and miscellaneous default parameters.

Table 9-1 Wand Emulation Default Table

Parameter	Default	Page Number
Wand Emulation Host Parameters		
Wand Emulation Host Types	Symbol OmniLink Interface Controller ¹	9-4
Leading Margin	80 msec	9-5
Polarity	Bar High/Margin Low	9-6
Ignore Unknown Characters	Send Bar Codes	9-6
Convert All Bar Codes to Code 39	Disable	9-7
Convert Code 39 to Full ASCII	Disable	9-8

¹User selection is required to configure this interface and this is the most common selection.

Wand Emulation Host Parameters

Wand Emulation Host Types

Scan one of the following bar codes to select a wand emulation host.

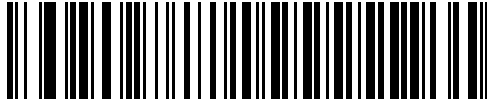

Symbol OmniLink Interface Controller¹

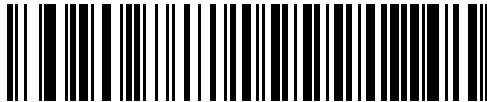

Symbol PDT Terminal (MSI)



Symbol PTC Terminal (Telxon)



NOTE ¹User selection is required to configure this interface and this is the most common selection.

Leading Margin (Quiet Zone)

Scan a bar code to select a leading margin duration. A leading margin is the time that precedes the first bar of the scan, in milliseconds. The minimum allowed value is 80 msec and the maximum is 250 msec. Use this parameter to accommodate older wand decoders which cannot handle short leading margins.

✓ **NOTE** 250 msec is the maximum value that this parameter can attain, however, 200 msec is sufficient.



*80 msec



140 msec



200 msec

Polarity

Polarity determines how the scanner's wand emulation interface creates the Digitized Barcode Pattern (DBP). DBP is a digital signal that represents the scanned bar code. Different decoders, to which this device could be attached, expect the DBP in a certain format. The DBP either has the "highs" represent bars and the "lows" represent spaces (margins), or the "highs" represent spaces (margins) and the "lows" represent bars.

Scan a bar code below to select the polarity required by your decoder.



***Bar High/Margin Low**



Bar Low/Margin High

Ignore Unknown Characters

Unknown characters are characters the host does not recognize. Select **Send Bar Codes With Unknown Characters** to send all bar code data except for unknown characters. The scanner sounds no error beeps.

When you select **Do Not Send Bar Codes With Unknown Characters**, bar codes containing at least one unknown character are not sent to the host, and the scanner sounds an error beep.



***Send Bar Codes With Unknown Characters**



Do Not Send Bar Codes With Unknown Characters

Convert All Bar Codes to Code 39

By default, the Wand Emulation interface sends data to the attached host in the symbology decoded. This can present a problem for customers with legacy systems that do not recognize some newer symbologies (for example, GS1 DataBar, formerly RSS).

Enable this parameter to ignore the decoded symbology, and output data as if it were a Code 39 bar code. Lowercase characters in the original data stream transmit as uppercase characters. This also allows ADF formatting.

If you enabled [Ignore Unknown Characters on page 9-6](#), characters that do not have a corresponding character in the Code 39 symbology set are replaced by a space.

If you disabled [Ignore Unknown Characters](#), and characters that do not have a corresponding character are encountered, the scanner emits an error beep and discards the data.

ADF Note: By default, the Wand Emulation interface does not allow ADF rules to process scanned data. Enabling this parameter allows ADF rules to process the scanned data (See [Chapter 13, Advanced Data Formatting](#)).



Enable Convert to Code 39 for Wand Host



***Disable Convert to Code 39 for Wand Host**

Convert Code 39 to Full ASCII

Disable this to replace any characters that do not have a corresponding character in the Code 39 symbology with a space.

Enable this to encode the data sent to the Wand Interface in Code 39 Full ASCII. The host must be able to interpret Code 39 Full ASCII data.

This setting applies only if you enabled **Convert to Code 39**.

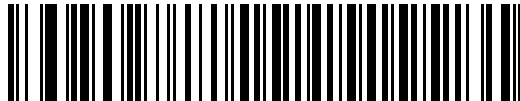

***Disable Code 39 Full ASCII Conversion**

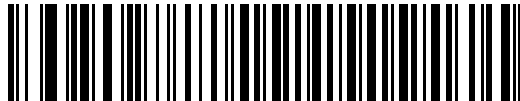

Enable Code 39 Full ASCII Conversion

Chapter 10 123Scan

Introduction

This chapter includes the bar code you must scan to use the 123Scan program.

123Scan is a Windows[®] based utility that enables programming the scanner with all parameters including Advanced Data Formatting (ADF) rules. An ADF rule modifies bar code data before it is sent to the host to ensure compatibility between bar code data and the host application. Scanners can be programmed via PC download or by scanning a sheet of bar codes generated by the utility. Scanner programming is saved in a file for electronic distribution. The 123Scan program includes a help file.

Communication With the 123Scan PC Based Configuration Tool

To communicate with the 123Scan program which runs on a host running a Windows operating system, use an RS-232 cable to connect the scanner to the host (see [Connecting an RS-232 Interface on page 6-2](#)).

123Scan requirements:

- Host computer with Windows
- Scanner
- RS-232 cable.

123Scan Parameter

To communicate with the 123Scan program, load 123Scan onto the host computer and scan the bar code below. Refer to 123Scan instructions for programming the scanner.



123Scan Configuration



NOTE Scanning this bar code enables the 123Scan interface on the scanner.

Chapter 11 Symbologies

Introduction

This chapter describes symbology features and provides programming bar codes for selecting these features. Before programming, follow the instructions in [Chapter 1, Getting Started](#).

The scanner ships with the settings in the [Symbology Default Table on page 11-2](#) (also see [Appendix A, Standard Default Parameters](#) for all host and miscellaneous scanner defaults). If the default values suit your requirements, programming is not necessary.

To return all features to default values, scan **Restore Defaults** on [page 4-3](#).

If not using a Synapse or USB cable, select a host type. See the appropriate host chapter for specific host information.

Scanning Sequence Examples

In most cases, scanning one bar code sets the parameter value. For example, to transmit bar code data without the UPC-A check digit, scan the **Do Not Transmit UPC-A Check Digit** bar code listed under [Transmit UPC-A/UPC-E/UPC-E1 Check Digit on page 11-14](#). The scanner issues a short high beep and the LED turns green, signifying a successful parameter entry.

Other parameters, such as **Set Length(s) for D 2 of 5** require scanning several bar codes in the proper sequence. See the individual parameter, such as **Set Length(s) for D 2 of 5**, for this procedure.

Errors While Scanning

Unless otherwise specified, to correct an error during a scanning sequence, just re-scan the correct parameter.

Symbology Default Parameters

[Table 11-1](#) lists the defaults for all symbologies parameters. To change any option, scan the appropriate bar code(s) provided in this chapter.

✓ **NOTE** See [Appendix A, Standard Default Parameters](#) for all user preferences, hosts, symbologies, and miscellaneous default parameters.

Table 11-1 Symbology Default Table

Parameter	Default	Page Number
UPC/EAN		
UPC-A	Enable	11-5
UPC-E	Enable	11-5
UPC-E1	Disable	11-6
EAN-8/JAN-8	Enable	11-7
EAN-13/JAN-13	Enable	11-7
Bookland EAN	Disable	11-8
Decode UPC/EAN Supplementals (2 and 5 digits)	Ignore	11-9
User-Programmable Supplementals Supplemental 1: Supplemental 2:		11-13
Decode UPC/EAN Supplemental Redundancy	20	11-13
Transmit UPC-A Check Digit	Transmit	11-14
Transmit UPC-E Check Digit	Transmit	11-14
Transmit UPC-E1 Check Digit	Transmit	11-14
UPC-A Preamble	System Character	11-16
UPC-E Preamble	System Character	11-17
UPC-E1 Preamble	System Character	11-18
Convert UPC-E to A	Disable	11-19
Convert UPC-E1 to A	Disable	11-19
EAN-8 Zero Extend	Disable	11-20
Bookland ISBN Format	ISBN-10	11-21
UCC Coupon Extended Code	Disable	11-22

Table 11-1 Symbology Default Table (Continued)

Parameter	Default	Page Number
Code 128		
Code 128	Enable	11-23
GS1-128 (formerly UCC/EAN-128)	Enable	11-23
ISBT 128 (non-concatenated)	Enable	11-24
Code 128 Decode Performance	Enable	11-24
Code 128 Decode Performance Level	Level 3	11-25
Code 39		
Code 39	Enable	11-26
Trioptic Code 39	Disable	11-27
Convert Code 39 to Code 32 (Italian Pharma Code)	Disable	11-28
Code 32 Prefix	Disable	11-28
Set Length(s) for Code 39	2 to 55	11-29
Code 39 Check Digit Verification	Disable	11-30
Transmit Code 39 Check Digit	Do not transmit	11-30
Code 39 Full ASCII Conversion	Disable	11-31
Buffer Code 39	Disable	11-31
Code 39 Decode Performance	Enable	11-34
Code 39 Decode Performance Level	Level 3	11-35
Code 93		
Code 93	Disable	11-36
Set Length(s) for Code 93	4 to 55	11-36
Code 11		
Code 11	Disable	11-38
Set Lengths for Code 11	4 to 55	11-38
Code 11 Check Digit Verification	Disable	11-40
Transmit Code 11 Check Digit	Do not transmit	11-41
Interleaved 2 of 5 (ITF)		
Interleaved 2 of 5 (ITF)	Disable	11-42
Set Length(s) for I 2 of 5	14	11-42

Table 11-1 Symbology Default Table (Continued)

Parameter	Default	Page Number
I 2 of 5 Check Digit Verification	Disable	11-44
Transmit I 2 of 5 Check Digit	Do not transmit	11-45
Convert I 2 of 5 to EAN 13	Disable	11-45
Discrete 2 of 5 (DTF)		
Discrete 2 of 5	Disable	11-46
Set Length(s) for D 2 of 5	12	11-46
Chinese 2 of 5		
Enable/Disable Chinese 2 of 5	Disable	11-48
Codabar (NW - 7)		
Codabar	Disable	11-48
Set Lengths for Codabar	5 to 55	11-49
CLSI Editing	Disable	11-50
NOTIS Editing	Disable	11-50
MSI		
MSI	Disable	11-51
Set Length(s) for MSI	4 to 55	11-51
MSI Check Digits	One	11-53
Transmit MSI Check Digit	Disable	11-53
MSI Check Digit Algorithm	Mod 10/Mod 10	11-54
GS1 DataBar (formerly RSS, Reduced Space Symbology)		
GS1 DataBar-14	Enable (LS9208) Disable (LS9208i)	11-55
GS1 DataBar Limited	Disable	11-56
GS1 DataBar Expanded	Enable (LS9208) Disable (LS9208i)	11-56
Convert GS1 DataBar to UPC/EAN	Disable	11-57
Symbology - Specific Security Levels		
Redundancy Security Levels	1	11-59
Security Level	0	11-61
Intercharacter Gaps	Normal	11-62

UPC/EAN

Enable/Disable UPC-A/UPC-E

To enable or disable UPC-A or UPC-E, scan the appropriate bar code below.



***Enable UPC-A**

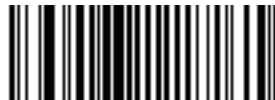

Disable UPC-A

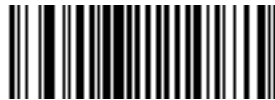

***Enable UPC-E**

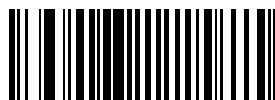

Disable UPC-E

Enable/Disable UPC-E1

To enable or disable UPC-E1, scan the appropriate bar code below.

✓ **NOTE** UPC-E1 is not a UCC (Uniform Code Council) approved symbology.



Enable UPC-E1



***Disable UPC-E1**

Enable/Disable EAN-13/JAN-13/EAN-8/JAN-8

To enable or disable EAN-13/JAN-13 or EAN-8/JAN-8, scan the appropriate bar code below.

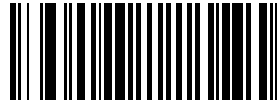

***Enable EAN-13/JAN-13**

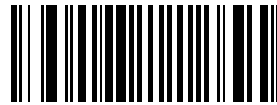

Disable EAN-13/JAN-13

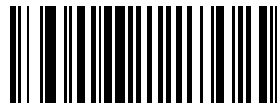

***Enable EAN-8/JAN-8**

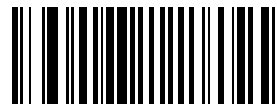

Disable EAN-8/JAN-8

Enable/Disable Bookland EAN

To enable or disable Bookland EAN, scan the appropriate bar code below.



Enable Bookland EAN



***Disable Bookland EAN**



NOTE If you enable Bookland EAN, select a [Bookland ISBN Format on page 11-21](#). Also select either Decode UPC/EAN Supplementals, Autodiscriminate UPC/EAN Supplementals, or Enable 978/979 Supplemental Mode in [Decode UPC/EAN Supplementals on page 11-9](#).

Decode UPC/EAN Supplementals

Supplementals are additionally appended characters (2 or 5) according to specific code format conventions (e.g., UPC A+2, UPC E+2, EAN 8+2). The following options are available:

- If you select **Ignore UPC/EAN Supplementals**, and the scanner is presented with a UPC/EAN plus supplemental symbol, the scanner decodes UPC/EAN and ignores the supplemental characters.
- If you select **Decode UPC/EAN with Supplementals**, the scanner only decodes UPC/EAN symbols with supplemental characters, and ignores symbols without supplementals.
- If you select **Autodiscriminate UPC/EAN Supplementals**, the scanner decodes UPC/EAN symbols with supplemental characters immediately. If the symbol does not have a supplemental, the scanner must decode the bar code the number of times set via [UPC/EAN Supplemental Redundancy on page 11-13](#) before transmitting its data to confirm that there is no supplemental.
- If you select one of the following **Supplemental Mode** options, the scanner immediately transmits EAN-13 bar codes starting with that prefix that have supplemental characters. If the symbol does not have a supplemental, the scanner must decode the bar code the number of times set via [UPC/EAN Supplemental Redundancy on page 11-13](#) before transmitting its data to confirm that there is no supplemental. The scanner transmits UPC/EAN bar codes that do not have that prefix immediately.
 - **Enable 378/379 Supplemental Mode**
 - **Enable 978/979 Supplemental Mode**

✓ **NOTE** If you select 978/979 Supplemental Mode and are scanning Bookland EAN bar codes, see [Enable/Disable Bookland EAN on page 11-8](#) to enable Bookland EAN, and select a format using [Bookland ISBN Format on page 11-21](#).

- **Enable 977 Supplemental Mode**
- **Enable 414/419/434/439 Supplemental Mode**
- **Enable 491 Supplemental Mode**
- **Enable Smart Supplemental Mode** - applies to EAN-13 bar codes starting with any prefix listed previously.
- **Supplemental User-Programmable Type 1** - applies to EAN-13 bar codes starting with a 3-digit user-defined prefix. Set this 3-digit prefix using [User-Programmable Supplementals on page 11-13](#).
- **Supplemental User-Programmable Type 1 and 2** - applies to EAN-13 bar codes starting with either of two 3-digit user-defined prefixes. Set the 3-digit prefixes using [User-Programmable Supplementals on page 11-13](#).
- **Smart Supplemental Plus User-Programmable 1** - applies to EAN-13 bar codes starting with any prefix listed previously or the user-defined prefix set using [User-Programmable Supplementals on page 11-13](#).
- **Smart Supplemental Plus User-Programmable 1 and 2** - applies to EAN-13 bar codes starting with any prefix listed previously or one of the two user-defined prefixes set using [User-Programmable Supplementals on page 11-13](#).

✓ **NOTE** To minimize the risk of invalid data transmission, select either to decode or ignore supplemental characters.

Decode UPC/EAN/JAN Supplementals (continued)



***Ignore UPC/EAN/JAN With Supplementals**



Decode UPC/EAN/JAN Only With Supplementals



Autodiscriminate UPC/EAN/JAN Supplementals



Enable 378/379 Supplemental Mode

Decode UPC/EAN/JAN Supplementals (continued)



Enable 978/979 Supplemental Mode



Enable 977 Supplemental Mode



Enable 414/419/434/439 Supplemental Mode



Enable 491 Supplemental Mode



Enable Smart Supplemental Mode

Decode UPC/EAN/JAN Supplementals (continued)



Supplemental User-Programmable Type 1



Supplemental User-Programmable Type 1 and 2



Smart Supplemental Plus User-Programmable 1



Smart Supplemental Plus User-Programmable 1 and 2

User-Programmable Supplementals

If you selected a Supplemental User-Programmable option from [Decode UPC/EAN Supplementals on page 11-9](#), select **User-Programmable Supplemental 1** to set the 3-digit prefix. Then select the 3 digits using the numeric bar codes beginning on [page D-1](#). Select **User-Programmable Supplemental 2** to set a second 3-digit prefix. Then select the 3 digits using the numeric bar codes beginning on [page D-1](#).



Supplemental User-Programmable 1



Supplemental User-Programmable 2

UPC/EAN Supplemental Redundancy

If you selected **Autodiscriminate UPC/EAN Supplementals** or one of the supplemental modes, this option adjusts the number of times to decode a symbol without supplementals before transmission. The range is from 2 to 30 times. Motorola recommends five or above when decoding a mix of UPC/EAN symbols with and without supplementals. The default is 20.

Scan the bar code below to set a decode redundancy value. Next, scan two numeric bar codes beginning on [page D-1](#). Single digit numbers must have a leading zero. If you make an error, or wish to change your selection, scan **Cancel** on [page D-4](#).

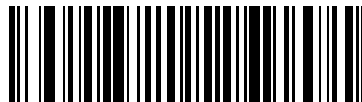

UPC/EAN Supplemental Redundancy

Transmit UPC-A/UPC-E/UPC-E1 Check Digit

The check digit is the last character of the symbol used to verify the integrity of the data. Scan the appropriate bar code below to transmit the bar code data with or without the UPC-A, UPC-E or UPC-E1 check digit. It is always verified to guarantee the integrity of the data.



***Transmit UPC-A Check Digit**



Do Not Transmit UPC-A Check Digit

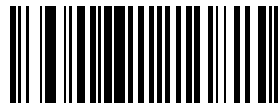

***Transmit UPC-E Check Digit**

Transmit UPC-A/UPC-E/UPC-E1 Check Digit (continued)

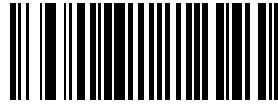

Do Not Transmit UPC-E Check Digit



***Transmit UPC-E1 Check Digit**



Do Not Transmit UPC-E1 Check Digit

UPC-A Preamble

Preamble characters are part of the UPC symbol, and include Country Code and System Character. There are three options for transmitting a UPC-A preamble to the host device: transmit System Character only, transmit System Character and Country Code ("0" for USA), and transmit no preamble. Select the appropriate option to match your host system.



No Preamble
(<DATA>)

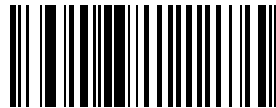

***System Character**
(<SYSTEM CHARACTER> <DATA>)

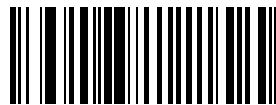

System Character & Country Code
(< COUNTRY CODE> <SYSTEM CHARACTER> <DATA>)

UPC-E Preamble

Preamble characters are part of the UPC symbol, and include Country Code and System Character. There are three options for transmitting a UPC-E preamble to the host device: transmit System Character only, transmit System Character and Country Code ("0" for USA), and transmit no preamble. Select the appropriate option to match your host system.

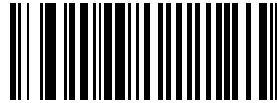

No Preamble
(<DATA>)

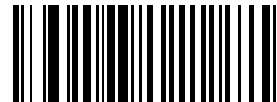

***System Character**
(<SYSTEM CHARACTER> <DATA>)



System Character & Country Code
(< COUNTRY CODE> <SYSTEM CHARACTER> <DATA>)

UPC-E1 Preamble

Preamble characters are part of the UPC symbol, and include Country Code and System Character. There are three options for transmitting a UPC-E1 preamble to the host device: transmit System Character only, transmit System Character and Country Code ("0" for USA), and transmit no preamble. Select the appropriate option to match your host system.



No Preamble
(<DATA>)



***System Character**
(<SYSTEM CHARACTER> <DATA>)



System Character & Country Code
(< COUNTRY CODE> <SYSTEM CHARACTER> <DATA>)

Convert UPC-E to UPC-A

Enable this to convert UPC-E (zero suppressed) decoded data to UPC-A format before transmission. After conversion, the data follows UPC-A format and is affected by UPC-A programming selections (e.g., Preamble, Check Digit).

Disable this to transmit UPC-E decoded data as UPC-E data, without conversion.

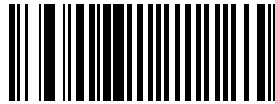

**Convert UPC-E to UPC-A
(Enable)**

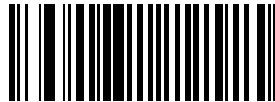

***Do Not Convert UPC-E to UPC-A
(Disable)**

Convert UPC-E1 to UPC-A

Enable this to convert UPC-E1 decoded data to UPC-A format before transmission. After conversion, the data follows UPC-A format and is affected by UPC-A programming selections (e.g., Preamble, Check Digit).

Disable this to transmit UPC-E1 decoded data as UPC-E1 data, without conversion.



**Convert UPC-E1 to UPC-A
(Enable)**



***Do Not Convert UPC-E1 to UPC-A
(Disable)**

EAN Zero Extend

Enable this to add five leading zeros to decoded EAN-8 symbols to make them compatible in format to EAN-13 symbols.

Disable this to transmit EAN-8 symbols as is.

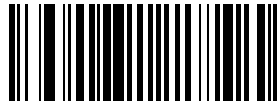

Enable EAN Zero Extend

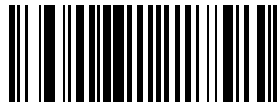

***Disable EAN Zero Extend**

Bookland ISBN Format

If you enabled Bookland EAN using [Enable/Disable Bookland EAN on page 11-8](#), select one of the following formats for Bookland data:

- **Bookland ISBN-10** - The scanner reports Bookland data starting with 978 in traditional 10-digit format with the special Bookland check digit for backward-compatibility. Data starting with 979 is not considered Bookland in this mode.
- **Bookland ISBN-13** - The scanner reports Bookland data (starting with either 978 or 979) as EAN-13 in 13-digit format to meet the 2007 ISBN-13 protocol.



***Bookland ISBN-10**



Bookland ISBN-13



NOTE For Bookland EAN to function properly, first enable Bookland EAN using [Enable/Disable Bookland EAN on page 11-8](#), then select either Decode UPC/EAN Supplementals, Autodiscriminate UPC/EAN Supplementals, or Enable 978/979 Supplemental Mode in [Decode UPC/EAN Supplementals on page 11-9](#).

UCC Coupon Extended Code

The UCC Coupon Extended Code is an additional bar code adjacent to a UCC Coupon Code. To enable or disable UCC Coupon Extended Code, scan the appropriate bar code below.



Enable UCC Coupon Extended Code



***Disable UCC Coupon Extended Code**

Code 128

Enable/Disable Code 128

To enable or disable Code 128, scan the appropriate bar code below.

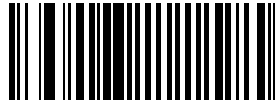

***Enable Code 128**

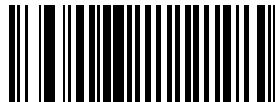

Disable Code 128

Enable/Disable GS1-128 (formerly UCC/EAN-128)

To enable or disable GS1-128, scan the appropriate bar code below.

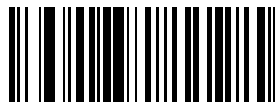

***Enable GS1-128**

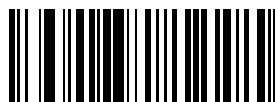

Disable GS1-128

Enable/Disable ISBT 128

ISBT 128 is a variant of Code 128 used in the blood banking industry. To enable or disable ISBT 128, scan the appropriate bar code below. If required, the host must perform concatenation of the ISBT data.



***Enable ISBT 128**

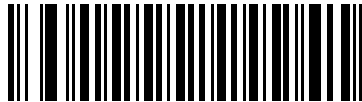

Disable ISBT 128

Code 128 Decode Performance

This option offers three levels of decode performance or “aggressiveness” for Code 128 symbols. Increasing the performance level reduces the amount of required bar code orientation, useful when scanning very long and/or truncated bar codes. Increased levels reduce decode security.

If you enable this option, you can select a [Code 128 Decode Performance Level on page 11-25](#) to suit performance needs.



***Enable Code 128 Decode Performance**



Disable Code 128 Decode Performance

Code 128 Decode Performance Level

This option offers three levels of decode performance or “aggressiveness” for Code 128 symbols. Increasing the performance level reduces the amount of required bar code orientation, useful when scanning very long and/or truncated bar codes. Increased levels reduce decode security.

Enable [Code 128 Decode Performance on page 11-24](#) before setting this parameter.



Code 128 Decode Performance Level 1



Code 128 Decode Performance Level 2



***Code 128 Decode Performance Level 3**

Code 39

Enable/Disable Code 39

To enable or disable Code 39, scan the appropriate bar code below.

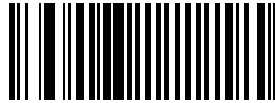

***Enable Code 39**

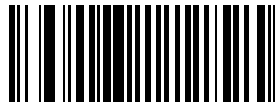

Disable Code 39



NOTE When encountering a large gap bar code, see [Symbology - Intercharacter Gap on page 11-62](#).

Enable/Disable Trioptic Code 39

Trioptic Code 39 is a variant of Code 39 used in the marking of computer tape cartridges. Trioptic Code 39 symbols always contain six characters. To enable or disable Trioptic Code 39, scan the appropriate bar code below.



Enable Trioptic Code 39



***Disable Trioptic Code 39**



NOTE You cannot enable Trioptic Code 39 and Code 39 Full ASCII simultaneously.

Convert Code 39 to Code 32

Code 32 is a variant of Code 39 used by the Italian pharmaceutical industry. Scan the appropriate bar code below to enable or disable converting Code 39 to Code 32.

✓ **NOTE** You must enable [Code 39](#) for this parameter to function.



Enable Convert Code 39 to Code 32



***Disable Convert Code 39 to Code 32**

Code 32 Prefix

Scan the appropriate bar code below to enable or disable adding the prefix character "A" to all Code 32 bar codes.

✓ **NOTE** You must enable [Convert Code 39 to Code 32](#) for this parameter to function.



Enable Code 32 Prefix



***Disable Code 32 Prefix**

Set Lengths for Code 39

The length of a code refers to the number of characters (i.e., human readable characters), including check digit(s) the code contains. Set lengths for Code 39 to any length, one or two discrete lengths, or lengths within a specific range. If Code 39 Full ASCII is enabled, **Length Within a Range** or **Any Length** are the preferred options.

✓ **NOTE** When setting lengths for different bar code types, include a leading zero for single digit numbers.

One Discrete Length - Select this option to decode only Code 39 symbols containing a selected length. Select the length using the numeric bar codes in [Appendix D, Numeric Bar Codes](#). For example, to decode only Code 39 symbols with 14 characters, scan **Code 39 - One Discrete Length**, then scan **1** followed by **4**. To correct an error or change your selection, scan **Cancel** on [page D-4](#).



Code 39 - One Discrete Length

Two Discrete Lengths - Select this option to decode only Code 39 symbols containing either of two selected lengths. Select the lengths using the numeric bar codes in [Appendix D, Numeric Bar Codes](#). For example, to decode only Code 39 symbols containing either 2 or 14 characters, select **Code 39 - Two Discrete Lengths**, then scan **0, 2, 1**, and then **4**. To correct an error or change your selection, scan **Cancel** on [page D-4](#).



Code 39 - Two Discrete Lengths

Length Within Range - Select this option to decode a Code 39 symbol within a specific length range. Select the lengths using the numeric bar codes in [Appendix D, Numeric Bar Codes](#). For example, to decode Code 39 symbols containing between 4 and 12 characters, first scan **Code 39 - Length Within Range**. Then scan **0, 4, 1**, and **2** (include a leading zero for single digit numbers). To correct an error or change your selection, scan **Cancel** on [page D-4](#).



Code 39 - Length Within Range

Any Length - Select this option to decode Code 39 symbols containing any number of characters within the scanner's capability.



Code 39 - Any Length

Code 39 Check Digit Verification

Enable this feature to check the integrity of all Code 39 symbols to verify that the data complies with specified check digit algorithm. Only Code 39 symbols which include a modulo 43 check digit are decoded when this feature is enabled. Only enable this feature if your code 39 symbols contain a modulo 43 check digit.

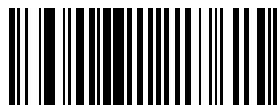

Enable Code 39 Check Digit

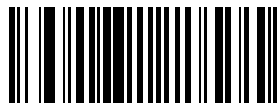

***Disable Code 39 Check Digit**

Transmit Code 39 Check Digit

Scan a bar code below to transmit Code 39 data with or without the check digit.



**Transmit Code 39 Check Digit
(Enable)**



***Do Not Transmit Code 39 Check Digit
(Disable)**



NOTE Enable [Code 39 Check Digit Verification](#) in order for this parameter to function.

Enable/Disable Code 39 Full ASCII

Code 39 Full ASCII is a variant of Code 39 which pairs characters to encode the full ASCII character set. To enable or disable Code 39 Full ASCII, scan the appropriate bar code below.

Code 39 Full ASCII to Full ASCII Correlation is host-dependent. See the *ASCII Character Set* table in the appropriate host chapter.



Enable Code 39 Full ASCII



***Disable Code 39 Full ASCII**



NOTE Do not enable Trioptic Code 39 and Code 39 Full ASCII simultaneously.

Code 39 Buffering (Scan & Store)

This feature allows the scanner to accumulate data from multiple Code 39 symbols.

Select the Scan and Store option (Buffer Code 39) to temporarily buffer all Code 39 symbols with a leading space as a first character for later transmission. The leading space is not buffered.

Decoding a valid Code 39 symbol with no leading space transmits in sequence all buffered data in a first-in first-out format, plus the “triggering” symbol. See the following pages for further details.

Select **Do Not Buffer Code 39** to transmit all decoded Code 39 symbols immediately without storing them in the buffer.

This feature affects Code 39 only. If you select **Buffer Code 39**, Motorola recommends configuring the scanner to decode Code 39 symbology only.



**Buffer Code 39
(Enable)**

Code 39 Buffering (Scan & Store) (continued)



*Do Not Buffer Code 39

While there is data in the transmission buffer, you cannot select **Do Not Buffer Code 39**. The buffer holds 200 bytes of information.

To disable Code 39 buffering when there is data in the transmission buffer, first force the buffer transmission (see [Transmit Buffer on page 11-33](#)) or clear the buffer.

Buffer Data

To buffer data, Code 39 buffering must be enabled and a Code 39 symbol must be read with a space immediately following the start pattern.

- Unless the data overflows the transmission buffer, the scanner issues a low/high beep to indicate successful decode and buffering. (For overflow conditions, see [Overfilling Transmission Buffer](#).)
- The scanner adds the decoded data excluding the leading space to the transmission buffer.
- No transmission occurs.

Clear Transmission Buffer

To clear the transmission buffer, scan the **Clear Buffer** bar code, which contains only a start character, a dash (minus), and a stop character.

- The scanner issues a short high/low/high beep.
- The scanner erases the transmission buffer.
- No transmission occurs.



Clear Buffer



NOTE The Clear Buffer contains only the dash (minus) character. In order to scan this command, be sure to set a Code 39 length to include length 1.

Transmit Buffer

There are two methods to transmit the Code 39 buffer.

1. Scan the **Transmit Buffer** bar code which contains only a start character, a plus (+), and a stop character.
 - The scanner transmits and clears the buffer.
 - The scanner issues a low/high beep.



Transmit Buffer

2. Scan a Code 39 bar code with a leading character other than a space.
 - The scanner issues a high/low beep to indicate a good decode and that decode data was buffered.
 - The scanner transmits and clears the buffer.
 - The scanner signals transmission of the buffer with a low/high beep.

✓ **NOTE** The Transmit Buffer contains only a plus (+) character. In order to scan this command, be sure to set a Code 39 length to include length 1.

Overfilling Transmission Buffer

The Code 39 buffer holds 200 characters. If a symbol decode results in an overflow of the transmission buffer:

- The scanner issues three long, high beeps to indicate that it rejected the symbol.
- No transmission occurs. This does not affect the data in the buffer.

Attempt to Transmit an Empty Buffer

If the symbol just read was the **Transmit Buffer** symbol and the Code 39 buffer is empty:

- A short low/high/low beep signals that the buffer is empty.
- No transmission occurs.
- The buffer remains empty.

Code 39 Decode Performance

This option offers three levels of decode performance or “aggressiveness” for Code 39 symbols. Increasing the performance level reduces the amount of required bar code orientation, useful when scanning very long and/or truncated bar codes. Increased levels reduce decode security.

If you enable this option, you can select a [Code 39 Decode Performance Level](#) to suit performance needs.



NOTE This option only works with Code 39 One Discrete Length.



***Enable Code 39 Decode Performance**



Disable Code 39 Decode Performance

Code 39 Decode Performance Level

This option offers three levels of decode performance or “aggressiveness” for Code 39 symbols. Increasing the performance level reduces the amount of required bar code orientation, useful when scanning very long and/or truncated bar codes. Increased levels reduce decode security.

Code 39 Decode Performance must be enabled.



Code 39 Decode Performance Level 1



Code 39 Decode Performance Level 2



***Code 39 Decode Performance Level 3**

Code 93

Enable/Disable Code 93

To enable or disable Code 93, scan the appropriate bar code below.



Enable Code 93



***Disable Code 93**

Set Lengths for Code 93

The length of a code refers to the number of characters (i.e., human readable characters), including check digit(s) the code contains. Set lengths for Code 93 for any length, one or two discrete lengths, or lengths within a specific range.

✓ **NOTE** When setting lengths for different bar code types, include a leading zero for single digit numbers.

One Discrete Length - Select this option to decode only Code 93 symbols containing a selected length. Select the length using the numeric bar codes in [Appendix D, Numeric Bar Codes](#). For example, to decode only Code 93 symbols with 14 characters, scan **Code 93 - One Discrete Length**, then scan **1** followed by **4**. To correct an error or to change your selection, scan **Cancel** on [page D-4](#).



Code 93 - One Discrete Length

Set Lengths for Code 93 (continued)

Two Discrete Lengths - Select this option to decode only Code 93 symbols containing either of two selected lengths. Select the lengths using the numeric bar codes in [Appendix D, Numeric Bar Codes](#). For example, to decode only those Code 93 symbols containing either 2 or 14 characters, select **Code 93 - Two Discrete Lengths**, then scan **0, 2, 1**, and then **4**. To correct an error or to change your selection, scan **Cancel** on [page D-4](#).



Code 93 - Two Discrete Lengths

Length Within Range - Select this option to decode a Code 93 symbol within a specific length range. Select the lengths using the numeric bar codes in [Appendix D, Numeric Bar Codes](#). For example, to decode Code 93 symbols containing between 4 and 12 characters, first scan **Code 93 - Length Within Range**. Then scan **0, 4, 1**, and **2** (include a leading zero for single digit numbers). To correct an error or to change your selection, scan **Cancel** on [page D-4](#).



Code 93 - Length Within Range

Any Length - Scan this option to decode Code 93 symbols containing any number of characters within the scanner's capability.



Code 93 - Any Length

Code 11

Code 11

To enable or disable Code 11, scan the appropriate bar code below.

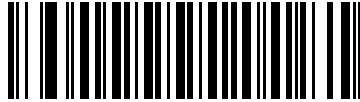

Enable Code 11

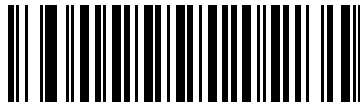

***Disable Code 11**

Set Lengths for Code 11

The length of a code refers to the number of characters (i.e., human readable characters), including check digit(s) the code contains. Set lengths for Code 11 for any length, one or two discrete lengths, or lengths within a specific range.

✓ **NOTE** When setting lengths for different bar code types, include a leading zero for single digit numbers.

One Discrete Length - Select this option to decode only Code 11 symbols containing a selected length. Select the length using the numeric bar codes in [Appendix D, Numeric Bar Codes](#). For example, to decode only Code 11 symbols with 14 characters, scan **Code 11 - One Discrete Length**, then scan **1** followed by **4**. To correct an error or to change your selection, scan **Cancel** on [page D-4](#)



Code 11 - One Discrete Length

Set Lengths for Code 11 (continued)

Two Discrete Lengths - Select this option to decode only Code 11 symbols containing either of two selected lengths. Select the lengths using the numeric bar codes in [Appendix D, Numeric Bar Codes](#). For example, to decode only Code 11 symbols containing either 2 or 14 characters, select **Code 11 - Two Discrete Lengths**, then scan **0, 2, 1**, and then **4**. To correct an error or to change your selection, scan **Cancel** on [page D-4](#).



Code 11 - Two Discrete Lengths

Length Within Range - Select this option to decode a Code 11 symbol within a specific length range. Select the lengths using the numeric bar codes in [Appendix D, Numeric Bar Codes](#). For example, to decode Code 11 symbols containing between 4 and 12 characters, first scan **Code 11 - Length Within Range**. Then scan **0, 4, 1**, and **2** (include a leading zero for single digit numbers). To correct an error or to change your selection, scan **Cancel** on [page D-4](#).



Code 11 - Length Within Range

Any Length - Scan this option to decode Code 11 symbols containing any number of characters within the scanner's capability.



Code 11 - Any Length

Code 11 Check Digit Verification

Enable this feature to check the integrity of all Code 11 symbols to verify that the data complies with the specified check digit algorithm. This selects the check digit mechanism for the decoded Code 11 bar code. The options are to check for one check digit, check for two check digits, or disable the feature.

To enable this feature, scan the bar code below corresponding to the number of check digits encoded in your Code 11 symbols.

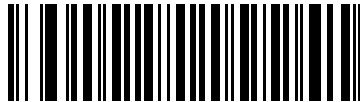

***Disable**

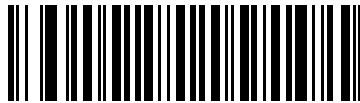

One Check Digit



Two Check Digits

Transmit Code 11 Check Digits

This feature selects whether or not to transmit the Code 11 check digit(s).



**Transmit Code 11 Check Digit
(Enable)**



***Do Not Transmit Code 11 Check Digit
(Disable)**



NOTE You must enable Code 11 Check Digit Verification for this parameter to function.

Interleaved 2 of 5 (ITF)

Enable/Disable Interleaved 2 of 5

To enable or disable Interleaved 2 of 5, scan the appropriate bar code below, and select an Interleaved 2 of 5 length from the following pages.

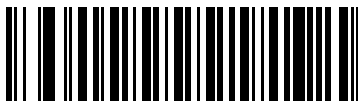

Enable Interleaved 2 of 5

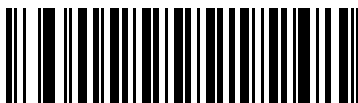

*Disable Interleaved 2 of 5

Set Lengths for Interleaved 2 of 5

The length of a code refers to the number of characters (i.e., human readable characters), including check digit(s) the code contains. Set lengths for I 2 of 5 to any length, one or two discrete lengths, or lengths within a specific range.

✓ **NOTE** When setting lengths for different bar code types, include a leading zero for single digit numbers.

One Discrete Length - Select this option to decode only I 2 of 5 symbols containing a selected length. Select the length using the numeric bar codes in [Appendix D, Numeric Bar Codes](#). For example, to decode only I 2 of 5 symbols with 14 characters, scan **I 2 of 5 - One Discrete Length**, then scan **1** followed by **4**. To correct an error or to change your selection, scan **Cancel** on [page D-4](#).



I 2 of 5 - One Discrete Length

Set Lengths for Interleaved 2 of 5 (continued)

Two Discrete Lengths - Select this option to decode only 1 2 of 5 symbols containing either of two selected lengths. Select the lengths using the numeric bar codes in [Appendix D, Numeric Bar Codes](#). For example, to decode only 1 2 of 5 symbols containing either 2 or 14 characters, select **1 2 of 5 - Two Discrete Lengths**, then scan **0, 2, 1**, and then **4**. To correct an error or to change your selection, scan **Cancel** on [page D-4](#).



1 2 of 5 - Two Discrete Lengths

Length Within Range - Select this option to decode a 1 2 of 5 symbol within a specific length range. Select the lengths using the numeric bar codes in [Appendix D, Numeric Bar Codes](#). For example, to decode 1 2 of 5 symbols containing between 4 and 12 characters, first scan **1 2 of 5 - Length Within Range**. Then scan **0, 4, 1**, and **2** (include a leading zero for single digit numbers). To correct an error or to change your selection, scan **Cancel** on [page D-4](#).



1 2 of 5 - Length Within Range

Any Length - Scan this option to decode 1 2 of 5 symbols containing any number of characters within the scanner's capability.



NOTE Due to the construction of the 1 2 of 5 symbology, it is possible for a scan line covering only a portion of the code to transmit as a complete scan, yielding less data than is encoded in the bar code. To prevent this, select specific lengths (1 2 of 5 - One Discrete Length, Two Discrete Lengths) for 1 2 of 5 applications.



1 2 of 5 - Any Length

I 2 of 5 Check Digit Verification

Enable this feature to check the integrity of all I 2 of 5 symbols to verify the data complies with either the specified Uniform Symbology Specification (USS), or the Optical Product Code Council (OPCC) check digit algorithm.



***Disable**



USS Check Digit



OPCC Check Digit

Transmit I 2 of 5 Check Digit

Scan the appropriate bar code below to transmit I 2 of 5 data with or without the check digit.



**Transmit I 2 of 5 Check Digit
(Enable)**



***Do Not Transmit I 2 of 5 Check Digit
(Disable)**

Convert I 2 of 5 to EAN-13

This parameter converts a 14 character I 2 of 5 code to EAN-13, and transmits to the host as EAN-13. To accomplish this, the I 2 of 5 code must be enabled, and the code must have a leading zero and a valid EAN-13 check digit.



**Convert I 2 of 5 to EAN-13
(Enable)**



***Do Not Convert I 2 of 5 to EAN-13
(Disable)**

Discrete 2 of 5 (DTF)

Enable/Disable Discrete 2 of 5

To enable or disable Discrete 2 of 5, scan the appropriate bar code below.



Enable Discrete 2 of 5



*Disable Discrete 2 of 5

Set Lengths for Discrete 2 of 5

The length of a code refers to the number of characters (i.e., human readable characters), including check digit(s) the code contains. Set lengths for D 2 of 5 to any length, one or two discrete lengths, or lengths within a specific range.

✓ **NOTE** When setting lengths for different bar code types, include a leading zero for single digit numbers.

One Discrete Length - Select this option to decode only D 2 of 5 symbols containing a selected length. Select the length using the numeric bar codes in [Appendix D, Numeric Bar Codes](#). For example, to decode only D 2 of 5 symbols with 14 characters, scan **D 2 of 5 - One Discrete Length**, then scan **1** followed by **4**. To correct an error or to change your selection, scan **Cancel** on [page D-4](#).



D 2 of 5 - One Discrete Length

Set Lengths for Discrete 2 of 5 (continued)

Two Discrete Lengths - Select this option to decode only D 2 of 5 symbols containing either of two selected lengths. Select the lengths using the numeric bar codes in [Appendix D, Numeric Bar Codes](#). For example, to decode only D 2 of 5 symbols containing either 2 or 14 characters, select **D 2 of 5 - Two Discrete Lengths**, then scan **0, 2, 1**, and then **4**. To correct an error or to change your selection, scan **Cancel** on [page D-4](#).



D 2 of 5 - Two Discrete Lengths

Length Within Range - Select this option to decode a D 2 of 5 symbol within a specific length range. Select the lengths using the numeric bar codes in [Appendix D, Numeric Bar Codes](#). For example, to decode D 2 of 5 symbols containing between 4 and 12 characters, first scan **D 2 of 5 - Length Within Range**. Then scan **0, 4, 1**, and **2** (include a leading zero for single digit numbers). To correct an error or to change your selection, scan **Cancel** on [page D-4](#).



D 2 of 5 - Length Within Range

Any Length - Scan this option to decode D 2 of 5 symbols containing any number of characters within the scanner's capability.



NOTE Due to the construction of the D 2 of 5 symbology, it is possible for a scan line covering only a portion of the code to transmit as a complete scan, yielding less data than is encoded in the bar code. To prevent this, select specific lengths (**D 2 of 5 - One Discrete Length, Two Discrete Lengths**) for D 2 of 5 applications.



D 2 of 5 - Any Length

Chinese 2 of 5

Enable/Disable Chinese 2 of 5

To enable or disable Chinese 2 of 5, scan the appropriate bar code below.



Enable Chinese 2 of 5



***Disable Chinese 2 of 5**

Codabar (NW - 7)

Enable/Disable Codabar

To enable or disable Codabar, scan the appropriate bar code below.



Enable Codabar

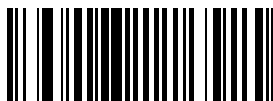

***Disable Codabar**



NOTE When encountering a large gap bar code, see [Symbology - Intercharacter Gap on page 11-62](#).

Set Lengths for Codabar

The length of a code refers to the number of characters (i.e., human readable characters), including check digit(s) the code contains. Set lengths for Codabar to any length, one or two discrete lengths, or lengths within a specific range.

✓ **NOTE** When setting lengths for different bar code types, include a leading zero for single digit numbers.

One Discrete Length - Select this option to decode only Codabar symbols containing a selected length. Select the length using the numeric bar codes in [Appendix D, Numeric Bar Codes](#). For example, to decode only Codabar symbols with 14 characters, scan **Codabar - One Discrete Length**, then scan **1** followed by **4**. To correct an error or to change your selection, scan **Cancel** on [page D-4](#).



Codabar - One Discrete Length

Two Discrete Lengths - Select this option to decode only Codabar symbols containing either of two selected lengths. Select the lengths using the numeric bar codes in [Appendix D, Numeric Bar Codes](#). For example, to decode only Codabar symbols containing either 2 or 14 characters, select **Codabar - Two Discrete Lengths**, then scan **0, 2, 1**, and then **4**. To correct an error or to change your selection, scan **Cancel** on [page D-4](#).



Codabar - Two Discrete Lengths

Length Within Range - Select this option to decode a Codabar symbol within a specific length range. Select the lengths using the numeric bar codes in [Appendix D, Numeric Bar Codes](#). For example, to decode Codabar symbols containing between 4 and 12 characters, first scan **Codabar - Length Within Range**. Then scan **0, 4, 1**, and **2** (include a leading zero for single digit numbers). To correct an error or to change your selection, scan **Cancel** on [page D-4](#).



Codabar - Length Within Range

Any Length - Scan this option to decode Codabar symbols containing any number of characters within the scanner's capability.



Codabar - Any Length

CLSI Editing

When enabled, this parameter strips the start and stop characters and inserts a space after the first, fifth, and tenth characters of a 14-character Codabar symbol. Enable this feature if the host system requires this data format.



NOTE Symbol length does not include start and stop characters.

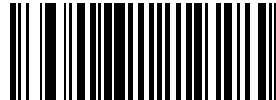

Enable CLSI Editing

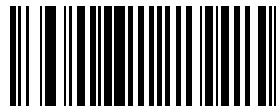

*Disable CLSI Editing

NOTIS Editing

When enabled, this parameter strips the start and stop characters from a decoded Codabar symbol. Enable this feature if the host system requires this data format.

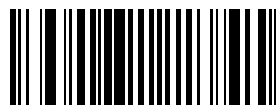

Enable NOTIS Editing

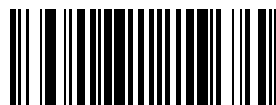

*Disable NOTIS Editing

MSI

Enable/Disable MSI

To enable or disable MSI, scan the appropriate bar code below.



Enable MSI



***Disable MSI**

Set Lengths for MSI

The length of a code refers to the number of characters (i.e., human readable characters), including check digit(s) the code contains. Set lengths for MSI to any length, one or two discrete lengths, or lengths within a specific range.

✓ **NOTE** When setting lengths for different bar code types, include a leading zero for single digit numbers.

One Discrete Length - Select this option to decode only MSI symbols containing a selected length. Select the length using the numeric bar codes in [Appendix D, Numeric Bar Codes](#). For example, to decode only MSI symbols with 14 characters, scan **MSI - One Discrete Length**, then scan **1** followed by **4**. To correct an error or to change your selection, scan **Cancel** on [page D-4](#).



MSI - One Discrete Length

Set Lengths for MSI (continued)

Two Discrete Lengths - Select this option to decode only MSI symbols containing either of two selected lengths. Select the lengths using the numeric bar codes in [Appendix D, Numeric Bar Codes](#). For example, to decode only MSI symbols containing either 2 or 14 characters, select **MSI - Two Discrete Lengths**, then scan **0**, **2**, **1**, and then **4**. To correct an error or to change your selection, scan **Cancel** on [page D-4](#).



MSI - Two Discrete Lengths

Length Within Range - Select this option to decode a MSI symbol within a specific length range. Select the lengths using the numeric bar codes in [Appendix D, Numeric Bar Codes](#). For example, to decode MSI symbols containing between 4 and 12 characters, first scan **MSI - Length Within Range**. Then scan **0**, **4**, **1**, and **2** (include a leading zero for single digit numbers). To correct an error or to change your selection, scan **Cancel** on [page D-4](#).



MSI - Length Within Range

Any Length - Scan this option to decode MSI symbols containing any number of characters within the scanner's capability.



NOTE Due to the construction of the MSI symbology, it is possible for a scan line covering only a portion of the code to transmit as a complete scan, yielding less data than is encoded in the bar code. To prevent this, set specific lengths (**MSI - One Discrete Length**, **Two Discrete Lengths**) for MSI applications.



MSI - Any Length

MSI Check Digits

With MSI symbols, one check digit is mandatory and always verified by the reader. The second check digit is optional. If your MSI codes include two check digits, enable the verification of the second check digit by scanning the barcode below.

See [MSI Check Digit Algorithm on page 11-54](#) to select second digit algorithms.



***One MSI Check Digit**



Two MSI Check Digits

Transmit MSI Check Digit(s)

Scan a bar code below to transmit MSI data with or without the check digit.



**Transmit MSI Check Digit(s)
(Enable)**



***Do Not Transmit MSI Check Digit(s)
(Disable)**

MSI Check Digit Algorithm

Two algorithms are possible for verifying the second MSI check digit. Select the bar code below corresponding to the algorithm used to encode the check digit.



MOD 10/MOD 11



***MOD 10/MOD 10**

GS1 DataBar (formerly RSS, Reduced Space Symbology)

The variants of GS1 DataBar are GS1 DataBar-14, GS1 DataBar Expanded, and GS1 DataBar Limited. The limited and expanded versions have stacked variants. Scan the appropriate bar codes to enable or disable each variant of GS1 DataBar.

GS1 DataBar-14



***Enable GS1 DataBar-14
(Default for the LS9208)**

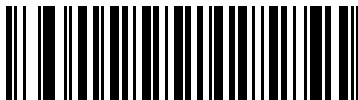

***Disable GS1 DataBar-14
(Default for the LS9208i)**

GS1 DataBar Limited

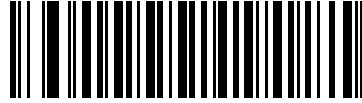

Enable GS1 DataBar Limited

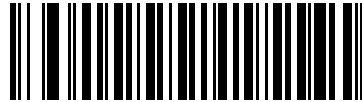

***Disable GS1 DataBar Limited**

GS1 DataBar Expanded

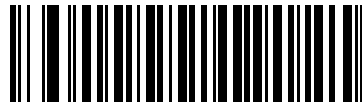

***Enable GS1 DataBar Expanded
(Default for the LS9208)**



***Disable GS1 DataBar Expanded
(Default for the LS9208i)**

Convert GS1 DataBar to UPC/EAN

The 14-digit Global Trade Item Number (GTIN) format is a standard as of January 2005 and uniquely identifies products worldwide. Although it is defined as a 14-digit structure, the bar code can contain 13 digits (EAN-13), 12 digits (UPC), or 8 digits (EAN-8) of data.

This parameter only applies to GS1 DataBar-14 and GS1 DataBar Limited symbols not decoded as part of a Composite symbol. Enable this to strip the leading 010 from GS1 DataBar-14 and GS1 DataBar Limited symbols encoding a single zero as the first digit, and report the bar code as EAN-13.

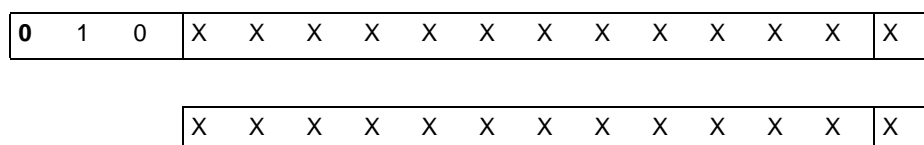

E.g. 0101234567890128 is converted to 1234567890128.

Symbols beginning with 0100 followed by 12 digits are converted to UPC-A, and with the leading 0100 stripped.

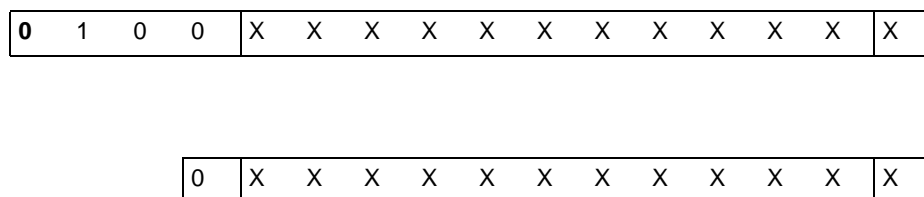

(if the UPC-A Preamble is System Character and Country Code)

or

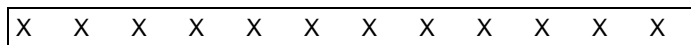

(if the UPC-A Preamble is System Character)

or

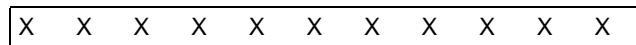

(if the UPC-A Preamble is No Preamble)

E.g. 0100123456789012 is converted to 0123456789012 if the UPC-A Preamble is System Character and Country Code, 123456789012 if the UPC-A Preamble is System Character, and 23456789012 if the Preamble is No Preamble.

Convert GS1 DataBar to UPC/EAN (continued)

Symbols beginning with 01, and followed by six zeroes and then 8 digits, are not converted.

0	1	0	0	0	0	0	0	X	X	X	X	X	X	X	X
---	---	---	---	---	---	---	---	---	---	---	---	---	---	---	---

E.g. 0100000012345670 remains 0100000012345670.



Enable Convert GS1 DataBar to UPC/EAN



***Disable Convert GS1 DataBar to UPC/EAN**

Symbology - Specific Security Levels

Redundancy Level

The scanner offers four levels of decode redundancy. Select higher redundancy levels for decreasing levels of bar code quality. As redundancy levels increase, the scanner's aggressiveness decreases.

Select the redundancy level appropriate for the bar code quality.

Redundancy Level 1

The following code types must be successfully read twice before being decoded:

Table 11-2 *Redundancy Level 1 Code Types*

Code Type	Length
Codabar	8 characters or less
MSI	4 characters or less
D 2 of 5	8 characters or less
I 2 of 5	8 characters or less

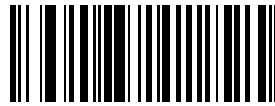

***Redundancy Level 1**

Redundancy Level 2

The following code types must be successfully read twice before being decoded:

Table 11-3 *Redundancy Level 2 Code Types*

Code Type	Length
All	All

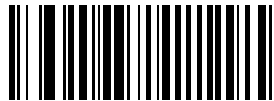

Redundancy Level 2

Redundancy Level 3

Code types other than the following must be successfully read twice before being decoded. The following codes must be read three times:

Table 11-4 *Redundancy Level 3 Code Types*

Code Type	Length
MSI	4 characters or less
D 2 of 5	8 characters or less
I 2 of 5	8 characters or less
Codabar	8 characters or less



Redundancy Level 3

Redundancy Level 4

The following code types must be successfully read three times before being decoded:

Table 11-5 *Redundancy Level 4 Code Types*

Code Type	Length
All	All

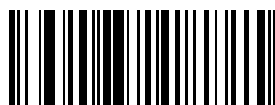

Redundancy Level 4

Security Level

The scanner offers four levels of decode security for the delta bar codes, which include the Code 128 family, UPC/EAN, Code 93 and Scanlet. Select increasing levels of security for decreasing levels of bar code quality. There is an inverse relationship between security and scanner aggressiveness, so choose only that level of security necessary for any given application.

Security Level 0

This default setting allows the scanner to operate fastest, while providing sufficient security in decoding most “in-spec” bar codes.



* Security Level 0

Security Level 1

Choose this option if misdecodes occur. This level eliminates most misdecodes.



Security Level 1

Security Level 2

Choose this option if Security Level 1 fails to eliminate misdecodes.



Security Level 2

Security Level 3

If you set Security Level 2, and still experience misdecodes, select this security level. Be advised, selecting this option is an extreme measure against misdecoding severely out of spec bar codes. Selecting this level of security can significantly impair the scanner’s decoding ability. If you need this level of security, try improving the quality of your bar codes.



Security Level 3

Symbology - Intercharacter Gap

Code 39 and Codabar symbols have an intercharacter gap that is typically quite small. Due to various bar code-printing technologies, this gap can grow larger than the maximum size allowed, preventing decode. If this problem occurs, scan the **Large Intercharacter Gaps** bar code to tolerate these out-of-specification bar codes.



***Normal Intercharacter Gaps**



Large Intercharacter Gaps

Chapter 12 Miscellaneous Scanner Options

Introduction

This chapter includes features frequently used to customize how data transmits to the host device. Also see each host chapter for the appropriate host connections and host device features for the scanner. See [Chapter 11, Symbologies](#) and [Chapter 13, Advanced Data Formatting](#) for customizing data for transmission to the host device.

Before programming, follow the instructions in [Chapter 1, Getting Started](#).

The scanner ships with the settings shown in the [Miscellaneous Scanner Options Default Table on page 12-2](#) (also see [Appendix A, Standard Default Parameters](#) for all host device and miscellaneous scanner defaults). If the default values suit requirements, programming is not necessary. Set feature values by scanning single bar codes or short bar code sequences.

Scanning Sequence Examples

In most cases, scan one bar code to set a specific parameter value. Other parameters, such as **Prefix Value**, require scanning several bar codes in sequence. See each individual parameter for descriptions of this procedure.

Errors While Scanning

Unless otherwise specified, to correct an error during a scanning sequence, just re-scan the correct parameter.

Miscellaneous Default Parameters

[Table 12-1](#) lists the defaults for miscellaneous scanner options. To change any option, scan the appropriate bar code(s) provided in the Miscellaneous Scanner Parameters section beginning on [page 12-3](#).

✓ **NOTE** See [Appendix A, Standard Default Parameters](#) for all user preferences, hosts, symbologies, and miscellaneous default parameters.

Table 12-1 *Miscellaneous Scanner Options Default Table*

Parameter	Default	Page Number
Transmit Code ID Character	Disable	12-3
Suffix Value (Value 1)	<CR><LF>	12-4
Prefix Value (Value 2)	None	12-4
FN1 Substitution Values	7013	12-5
Scan Data Options	Data as is	12-6
Transmit "No Read" Message	Disable	12-8
Report Version		12-9
Report MIMIC Version		12-9
Report Synapse Cable		12-9

Miscellaneous Scanner Parameters

Transmit Code ID Character

A Code ID character identifies the code type of a scanned bar code. This is useful when decoding more than one code type. In addition to any single character prefix already selected, the Code ID character is inserted between the prefix and the decoded symbol.

Select no Code ID character, a Symbol Code ID character, or an AIM Code ID character. For Code ID Characters, see [Symbol Code Identifiers on page B-1](#) and [AIM Code Identifiers on page B-2](#).

- ✓ **NOTE** If you enable Symbol Code ID Character or AIM Code ID Character, and enable [Transmit "No Read" Message on page 12-8](#), the scanner appends the code ID for Code 39 to the NR message.

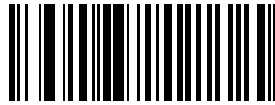

Symbol Code ID Character

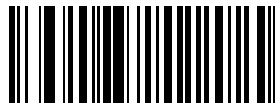

AIM Code ID Character

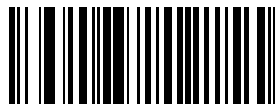

*None

Prefix/Suffix Values

You can append a prefix/suffix to scan data for use in data editing. To set these values, scan a prefix or suffix bar code, then scan a four-digit number (i.e., four bar codes) that corresponds to key codes for various terminals using the numeric bar codes in [Appendix D, Numeric Bar Codes](#). Code 39 Full ASCII to Full ASCII Correlation is host-dependent. See the *ASCII Character Set* table in the appropriate host chapter. To correct an error or change your selection, scan **Cancel** on [page D-4](#).

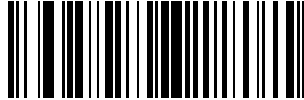

Scan Suffix (Value 1)

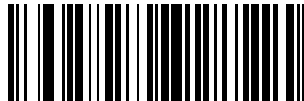

Scan Prefix (Value 2)



Set Value 3

Prefix/Suffix Values (Continued)



Set Value 4



Set Value 5



Set FN1 Substitution Value (Value 6)

FN1 Substitution Values

The Wedge and USB HID Keyboard hosts support a FN1 Substitution feature. If this feature is enabled, set a FN1 Substitution Value to replace any FN1 character (0x1b) in an EAN128 bar code. This value defaults to 7013 (Enter Key).

1. Scan the bar code below.



FN1 Substitution Value (Value 6)

2. Locate the keystroke for FN1 Substitution in the *ASCII Character Set* table in the appropriate host chapter for your host. Enter the 4-digit ASCII value by scanning each digit in [Appendix D, Numeric Bar Codes](#).

Scan Data Options

To change the Scan Data Transmission Format, scan the **Scan Options** bar code below. Then select one of four options:

- Data As Is
- <DATA> <SUFFIX>
- <PREFIX> <DATA>
- <PREFIX> <DATA> <SUFFIX>

Scan the **Enter** bar code on [page 12-7](#). If you make a mistake, scan the **Data Format Cancel** bar code on [page 12-7](#).

To insert a carriage return/enter after each bar code scanned, scan the following bar codes in order:

1. <SCAN OPTIONS>
2. <DATA> <SUFFIX>
3. Enter (on [page 12-7](#))

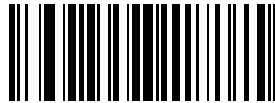

Scan Options



***Data As Is**

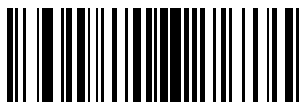

<DATA> <SUFFIX>

Scan Data Transmission Format (Continued)

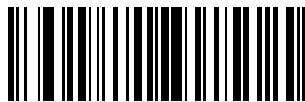

<PREFIX> <DATA>



<PREFIX> <DATA> <SUFFIX>



Enter



Data Format Cancel

Transmit “No Read” Message

Scan a bar code below to select whether or not to transmit a No Read message. When enabled, the characters NR transmit when a bar code is not decoded. Any enabled prefixes or suffixes are appended around this message. When disabled, if a symbol does not decode, nothing transmits to the host.



NOTE If you enable **Transmit No Read**, and also enable Symbol Code ID Character or AIM Code ID Character for [Transmit Code ID Character on page 12-3](#), the scanner appends the code ID for Code 39 to the NR message.



Enable No Read



***Disable No Read**

Report Version

Scan the bar code below to report the software revision installed in the scanner's primary microprocessor.



Report Software Version

Report MIMIC Version

Scan the bar code below to report the MIMIC software revision installed in the scanner's secondary microprocessor. Scanners that do not use MIMIC architecture report nothing.



Report MIMIC Software Version

Report Synapse Cable

Scan the bar code below to report the software revision of the attached Synapse cable. If the scanner does not detect an attached Synapse cable, it reports *Synapse not attached*.



Report Synapse Cable

Chapter 13 Advanced Data Formatting

Introduction

Advanced Data Formatting (ADF) is a means of customizing data before transmission to your host device. Edit scan data to suit your particular requirements.

Implement ADF by scanning a related series of bar codes, which begin on [page 13-6](#), or by installing the 123Scan utility (see [Chapter 10, 123Scan](#)) which allows programming the scanner with ADF rules.

✓ **NOTE** If using the Wand interface with the scanner, you cannot use ADF rules to format data.

Rules: Criteria Linked to Actions

ADF uses **rules** to customize data. These rules perform detailed actions when the data meets certain criteria. One rule may consist of single or multiple criteria applied to single or multiple actions.

For instance, a data formatting rule could be:

Criteria: *When scan data is Code 39, length 12, and data at the start position is the string "129",*

Actions: *pad all sends with zeros to length 8,
send all data up to X,
send a space.*

Scanning a Code 39 bar code of 1299X1559828 transmits the following: 00001299<space>. If you scan a Code 39 bar code of 1299X15598, this rule is ignored because the bar code doesn't meet the length criteria.

The rule specifies the editing conditions and requirements before data transmission occurs.

Using ADF Bar Codes

When programming a rule, make sure the rule is logically correct. Plan ahead before scanning.

To program each data formatting rule:

- **Start the Rule.** Scan the [Begin New Rule bar code on page 13-6](#).
- **Specify Criteria.** Scan bar codes for all pertinent criteria. Criteria can include code type (e.g., Code 128), code length, or data that contains a specific character string (e.g., the digits “129”). See [Criteria on page 13-10](#).
- **Specify Actions.** Scan all actions related to, or affecting, these criteria. The actions of a rule specify how to format data for transmission. See [ADF Bar Code Menu Example bar code on page 13-2](#).
- **Save the Rule.** Scan the [Save Rule bar code on page 13-6](#). This places the rule in the “top” position in the rule buffer.
- Use special-purpose bar codes to correct errors that occur during this process: **Erase Criteria and Start Again, Erase Actions and Start Again, Erase Previously Saved Rule**, etc.

Use the [Erase](#) bar codes on [page 13-7](#) to erase criteria, actions, and entire rules.

ADF Bar Code Menu Example

This section provides an example of how to enter ADF rules for scan data.

An auto parts distribution center wants to encode manufacturer ID, part number, and destination code into their own Code 128 bar codes. The distribution center also has products that carry UPC bar codes, placed there by the manufacturer. The Code 128 bar codes have the following format:

MMMMPPPPDD

Where: M = Manufacturer ID
 P = Part Number
 D = Destination Code

The distribution center uses a PC with dedicated control characters for manufacturer ID <CTRL M>, part number <CTRL P>, and destination code <CTRL D>. At this center the UPC data is treated as manufacturer ID code.

The following rules must be entered:

When scanning data of code type Code 128, send the next 5 characters, send the manufacturer ID key <CTRL M>, send the next 5 characters, send the part number key <CTRL P>, send the next 2 characters, send the destination code key <CTRL D>.

When scanning data of code type UPC/EAN, send all data, send the manufacturer ID key <CTRL M>.

To enter these rules, follow the steps below:

Rule 1: The Code 128 Scanning Rule

Step	Bar Code	On Page	Beep Indication
1	Begin New Rule	13-6	High High
2	Code 128	13-11	High High
3	Send next 5 characters	13-31	High High
4	Send <CTRL M>	13-75	High High
5	Send next 5 characters	13-31	High High
6	Send <CTRL P>	13-76	High High
7	Send next 2 characters	13-30	High High
8	Send <CTRL D>	13-72	High High
9	Save Rule	13-6	High Low High Low

Rule 2: The UPC Scanning Rule

Step	Bar Code	On Page	Beep Indication
1	Begin New Rule	13-6	High High
2	UPC/EAN	13-13	High High
3	Send all remaining data	13-29	High High
4	Send <CTRL M>	13-75	High High
5	Save Rule	13-6	High Low High Low

If you make a mistake while entering this rule, scan the [Quit Entering Rules bar code on page 13-8](#). If you already saved the rule, scan the [Erase Previously Saved Rule bar code on page 13-7](#).

Alternate Rule Sets

You can group ADF rules into one of four alternate sets which you can turn on and off when needed. This is useful to format the same message in different ways. For example, a Code 128 bar code contains the following information:

Class (2 digits), Stock Number (8) digits, Price (5 digits)

This bar code might look like this:

245671243701500

where:

Class = 24

Stock Number = 56712437

Price = 01500

Ordinarily you would send this data as follows:

24 (class key)

56712437 (stock key)

01500 (enter key)

But, when there is a sale, you want to send only the following:

24 (class key)

56712437 (stock key)

and the cashier keys the price manually.

To implement this, first enter an ADF rule that applies to the normal situation, such as:

When scanning a bar code of length 15, send the next 2 characters, send the class key, send the next 8 characters, send the stock key, send the data that remains, send the Enter key.

The “sale” rule may look like this:

When scanning a bar code of length 15, send the next 2 characters, send the class key, send the next 8 characters, send the stock key.

To switch between the two sets of rules, program a “switching rule” to specify the type of bar code to scan to switch between the rule sets. For example, in the case of the previous “sale” rule, the rule programmer wants the cashier to scan the bar code “M” before a sale. To do this, enter the following rule:

When scanning a bar code of length 1 that begins with “M”, select rule set number 1.

Program another rule to switch back:

When scanning a bar code of length 1 that begins with “N”, turn off rule set number 1.

Or include the switching back to normal rules in the “sale” rule:

When scanning a bar code of length 15, send the next 2 characters, send the class key, send the next 8 characters, send the stock key, turn off rule set 1.

For optimal results, scan the [Disable All Rule Sets bar code on page 13-9](#) after programming a rule belonging to an alternate rule set.

In addition to enabling and disabling rule sets within the rules, enable or disable them by scanning the appropriate bar codes on [page 13-9](#).

Rules Hierarchy (in Bar Codes)

The order of programming individual rules is important. Program the most general rule first.

All programmed rules are stored in a buffer. As they are programmed, they are stored at the “top” of a rules list. If you create three rules, the list is configured as follows:

Third Rule

Second Rule

First Rule

When scanning data, the rules list is checked from top to bottom to determine if the criteria matches (and therefore, if the actions occur). Input is modified into the data format specified by the first matching set of criteria it finds. Be sure to program the most general rule first.

For example, if the THIRD rule states:

When scanning a bar code of any length, send all data, then send the ENTER key.

And the SECOND rule states:

When scanning a Code 128 bar code of length 12, send the first four characters, then send the ENTER key, then send all remaining data.

If you scan a Code 128 bar code of length 12, the THIRD rule would apply and the SECOND rule would appear to not function.

Note that using the standard data editing functions also creates ADF rules. Scan options are entered as ADF rules, and the hierarchy mentioned previously also applies to them. For the Symbol LS9208/LS9208i, this applies to prefix/suffix programming in the parameter *Scan Data Transmission Format*.

These rules reside in the same “rule list” as ADF Rules, so the order of their creation is also important.

Default Rules

Every unit has a default rule to send all scan data. Units with custom software may have one or more default rules burned in. The rules hierarchy checks user programmable rules first, then the default rules. To disable default rules enter the following general rule in the user programmable buffer:

When receiving scan data, send all data.

Since this rule always applies, ADF never uses the default rules.

Special Commands

Pause Duration

This parameter inserts a pause in the data transmission. To set the pause, scan a two-digit number (i.e., two bar codes) representing a 0.1 second interval. For example, using the numeric bar codes in [Appendix D, Numeric Bar Codes](#), scan bar codes **0** and **1** to insert a 0.1 second pause; or scan **5** and **0** for a 5 second pause. To correct an error or to change your selection, scan the [Cancel bar code on page D-4](#).

The default for **Pause Duration** is 1 second.



Pause Duration

Begin New Rule

Scan this bar code to start entering a new rule.



Begin New Rule

Save Rule

Scan this bar code to save the rule.



Save Rule

Erase

Use these bar codes to erase criteria, actions, or rules.



**Erase Criteria
And Start Again**



**Erase Actions
And Start Again**



**Erase Previously
Saved Rule**



Erase All Rules

Quit Entering Rules

Scan this bar code to quit entering rules.



**Quit Entering
Rules**

Disable Rule Set

Use these bar codes to disable rule sets.



Disable Rule Set 1



Disable Rule Set 2



Disable Rule Set 3

Disable Rule Set (Continued)



Disable Rule Set 4



Disable All Rule Sets

Criteria

Code Types

Select all code types to be affected by the rule. Scan all selected codes in succession, before selecting other criteria. *To select all code types, don't scan any code type.*



Code 39



Codabar

Code Types (Continued)



GS1 DataBar-14



GS1 DataBar Limited



GS1 DataBar Expanded



Code 128

Code Types (Continued)

Scan the bar codes for all code types desired before selecting other criteria.



D 2 OF 5



IATA 2 OF 5



I 2 OF 5



Code 93

Code Types (Continued)

Scan the bar codes for all code types desired before selecting other criteria.



UPC-A



UPC-E



EAN-8



EAN-13

Code Types (Continued)



MSI



EAN 128



UPC-E1



Bookland

Code Types (Continued)



Trioptic



Chinese 2 of 5



Coupon Code

Code Lengths

Scan these bar codes to define the number of characters the selected code types must contain. Select one length per rule only. *If you don't select a code length, selected code types of any length are affected.*



1 Character



2 Characters



3 Characters

Code Lengths (Continued)



4 Characters



5 Characters



6 Characters

Code Lengths (Continued)



7 Characters



8 Characters



9 Characters

Code Lengths (Continued)



10 Characters



11 Characters



12 Characters

Code Lengths (Continued)



13 Characters



14 Characters



15 Characters

Code Lengths (Continued)



16 Characters



17 Characters



18 Characters

Code Lengths (Continued)



19 Characters



20 Characters



21 Characters

Code Lengths (Continued)



22 Characters



23 Characters



24 Characters

Code Lengths (Continued)



25 Characters



26 Characters



27 Characters

Code Lengths (Continued)



28 Characters



29 Characters



30 Characters

Message Containing A Specific Data String

Use this feature to select whether the formatting affects data that begins with a specific character or data string, or contains a specific character or data string.

There are 5 features:

- Specific String at Start
- Specific String, Any Location
- Specific String Search
- Any Message OK
- Rule Belongs to Set

Specific String at Start

1. Scan the following bar code.
2. Scan the bar codes representing the desired character or characters (up to a total of 8) using the [Alphanumeric Keyboard on page 13-170](#).
3. Scan [End Of Message on page 13-191](#).



Specific String At Start

Specific String, Any Location

1. Scan the following bar code.
2. Enter a location by scanning a two-digit number representing the **position** (use a leading "zero" if necessary) using the [Numeric Bar Codes on page D-1](#).
3. Scan the bar codes representing the desired character or characters (up to a total of 8) using the [Alphanumeric Keyboard on page 13-170](#).
4. Scan [End Of Message on page 13-191](#).



Specific String Any Location

Specific String Search

1. Scan the following bar code.
2. Scan the bar codes representing the desired character or characters (up to a total of 10) using the [Alphanumeric Keyboard on page 13-170](#).
3. Scan [End Of Message on page 13-191](#).



Specific String Search

Any Message OK

Do not scan any bar code to format all selected code types, regardless of information contained.

Rule Belongs To Set

Scan a bar code below to select the set to which a rule belongs. There are four possible rule sets. See [Alternate Rule Sets on page 13-3](#) for more information.



Rule Belongs To Set 1



Rule Belongs To Set 2

Rule Belongs To Set (Continued)



Rule Belongs To Set 3



Rule Belongs To Set 4

Actions

Select how to format the data for transmission.

Send Data

Send all data that follows, send all data up to a specific character selected from the [Alphanumeric Keyboard on page 13-170](#), or send the next *X* characters. Note that only bar codes for **Send Next 1 to 20** appear here, and can be scanned multiple times to send values greater than 20. For instance, to send the next 28 characters, scan **Send Next 20 Characters**, then **Send Next 8 Characters**.

Use these bar codes to send data.



**Send All Data That
Remains**



**Send Data Up To
Character**



Send Next Character

Send Data (Continued)



**Send Next
2 Characters**



**Send Next
3 Characters**



**Send Next
4 Characters**

Send Data (Continued)



**Send Next
5 Characters**



**Send Next
6 Characters**



**Send Next
7 Characters**

Send Data (Continued)



**Send Next 8
Characters**



**Send Next
9 Characters**



**Send Next
10 Characters**

Send Data (Continued)



**Send Next
11 Characters**



**Send Next
12 Characters**



**Send Next
13 Characters**

Send Data (Continued)



**Send Next
14 Characters**



**Send Next
15 Characters**



**Send Next
16 Characters**

Send Data (Continued)



**Send Next
17 Characters**



**Send Next
18 Characters**



**Send Next
19 Characters**



**Send Next
20 Characters**

Setup Field(s)

Table 13-1 *Setup Field(s) Definitions*

Parameter	Description	Page
Move Cursor		
Move Cursor To a Character	Scan <i>Move Cursor To Character</i> , then any printable ASCII character from the <i>Alphanumeric Keyboard on page 13-170</i> . This moves the cursor to the position after the matching character. If the character is not there, the rule fails and ADF tries the next rule.	13-38
Move Cursor to Start of Data	Scan this bar code to move cursor to the beginning of the data.	13-38
Move Cursor Past a Character	This action moves the cursor past all sequential occurrences of a selected character. For example, if the selected character is 'A', then the cursor moves past 'A', 'AA', 'AAA', etc. Scan <i>Move Cursor Past Character</i> , then select a character from the <i>Alphanumeric Keyboard on page 13-170</i> . If the character is not there, the cursor does not move (i.e., has no effect).	13-38
Move Cursor Past a Specific String	This action moves the cursor past the first occurrence of a selected string. Scan <i>Move Cursor Past Specific String</i> , then select the character(s) (up to 10) using the <i>Alphanumeric Keyboard</i> . Scan the <i>End Of Message bar code on page 13-191</i> .	13-38
Move Cursor to Specific String and Replace	This action moves the cursor to the first occurrence of a selected string and replaces the string with another user-defined string. Scan <i>Move Cursor to Specific String and Replace</i> , then enter an alphanumeric string representing the character(s) (up to 10) to match and delete using the <i>Alphanumeric Keyboard</i> . Scan the <i>End Of Message bar code on page 13-191</i> . Enter another alphanumeric string representing the character(s) (up to 10) to insert using the <i>Alphanumeric Keyboard</i> . Scan <i>End Of Message</i> .	13-39
Move Cursor to Last Occurrence of String and Replace All	This action replaces all occurrences of a selected string with another user-defined string, and moves the cursor to the beginning of the last occurrence. Scan <i>Move Cursor to Last Occurrence of String and Replace All</i> , then enter an alphanumeric string representing the character(s) (up to 10) to match and delete using the <i>Alphanumeric Keyboard</i> . Scan the <i>End Of Message bar code on page 13-191</i> . Enter another alphanumeric string representing the character(s) (up to 10) to insert using the <i>Alphanumeric Keyboard</i> . Scan <i>End Of Message</i> .	13-39
Skip to End	Scan <i>Skip to End</i> to move cursor to the end of the data.	13-39

Table 13-1 Setup Field(s) Definitions (Continued)

Parameter	Description	Page
Skip Ahead "N" Characters	Scan one of these bar codes to select the number of positions ahead to move the cursor.	13-40
Skip Back "N" Characters	Scan one of these bar codes to select the number of positions back to move the cursor.	13-43
Send Preset Value	<p>Send Values 1 through 6 by scanning the appropriate bar code. Set these values using the prefix/suffix values in Table 6-4 on page 6-22.</p> <p>Value 1 = Scan Suffix; Value 2 = Scan Prefix Value 6 = FN1 Substitution Value</p>	13-46

Move Cursor

Scan a bar code below to move the cursor in relation to a specified character. Then enter a character by scanning a bar code from the [Alphanumeric Keyboard on page 13-170](#).

✓ **NOTE** If there is no match when the rule is interpreted and the rule fails, the next rule is checked.



**Move Cursor To
Character**



Move Cursor To Start



**Move Cursor Past
Character**



**Move Cursor Past
Specific String**

Move Cursor



**Move Cursor to
Specific String and Replace**



**Move Cursor to Last Occurrence
of String and Replace All**



Skip to End

Scan the bar code below to insert a pause in the data transmission. The value of the **Pause Duration** parameter controls the length of this pause.



Send Pause

Skip Ahead

Use the following bar codes to skip ahead characters.



**Skip Ahead
1 Character**



**Skip Ahead
2 Characters**

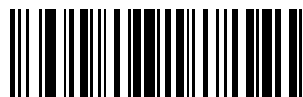

**Skip Ahead
3 Characters**



**Skip Ahead
4 Characters**

Skip Ahead (Continued)



**Skip Ahead
5 Characters**



**Skip Ahead
6 Characters**



**Skip Ahead
7 Characters**

Skip Ahead (Continued)

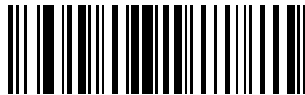

**Skip Ahead
8 Characters**



**Skip Ahead
9 Characters**



**Skip Ahead
10 Characters**

Skip Back

Use the following bar codes to skip back characters.



**Skip Back
1 Characters**



**Skip Back
2 Characters**



**Skip Back
3 Characters**

Skip Back (Continued)



**Skip Back
4 Characters**



**Skip Back
5 Characters**



**Skip Back
6 Characters**

Skip Back (Continued)



**Skip Back
7 Characters**



**Skip Back
8 Characters**



**Skip Back
9 Characters**

Skip Back (Continued)



**Skip Back
10 Characters**

Send Preset Value

Use these bar codes to send preset values.



Send Value 1



Send Value 2

Send Preset Value (Continued)



Send Value 3



Send Value 4



Send Value 5



Send Value 6

Modify Data

Modify data as described below. The following actions work for all send commands that follow it within a rule. Programming *pad zeros to length 6, send next 3 characters, stop padding, send next 5 characters* adds three zeros to the first send, and does not affect the next send. These options do not apply to the **Send Keystroke** or **Send Preset Value** options.

Remove All Spaces

To remove all spaces in the send commands that follow, scan this bar code.

Crunch All Spaces

To leave one space between words, scan this bar code. This also removes all leading and trailing spaces.

Stop Space Removal

Scan this bar code to disable space removal.

Remove Leading Zeros

Scan this bar code to remove all leading zeros.

Stop Zero Removal

Scan this bar code to disable the removal of zeros.



Remove All Spaces



Crunch All Spaces

Modify Data (Continued)



Stop Space Removal



**Remove Leading
Zeros**



Stop Zero Removal

Pad Data with Spaces

To pad data to the left, scan the bar code containing the desired number of spaces. Send commands activate this parameter.



**Pad Spaces To
Length 1**



**Pad Spaces To
Length 2**



**Pad Spaces To
Length 3**



**Pad Spaces To
Length 4**

Pad Data with Spaces (Continued)



**Pad Spaces To
Length 5**



**Pad Spaces To
Length 6**



**Pad Spaces To
Length 7**

Pad Data with Spaces (Continued)



**Pad Spaces To
Length 8**



**Pad Spaces To
Length 9**



**Pad Spaces To
Length 10**

Pad Data with Spaces (Continued)



**Pad Spaces To
Length 11**



**Pad Spaces To
Length 12**



**Pad Spaces To
Length 13**

Pad Data with Spaces (Continued)



**Pad Spaces To
Length 14**



**Pad Spaces To
Length 15**



**Pad Spaces To
Length 16**

Pad Data with Spaces (Continued)



**Pad Spaces To
Length 17**



**Pad Spaces To
Length 18**



**Pad Spaces To
Length 19**

Pad Data with Spaces (Continued)



**Pad Spaces To
Length 20**



**Pad Spaces To
Length 21**



**Pad Spaces To
Length 22**

Pad Data with Spaces (Continued)



**Pad Spaces To
Length 23**



**Pad Spaces To
Length 24**



**Pad Spaces To
Length 25**

Pad Data with Spaces (Continued)



**Pad Spaces To
Length 26**



**Pad Spaces To
Length 27**



**Pad Spaces To
Length 28**

Pad Data with Spaces (Continued)



**Pad Spaces To
Length 29**



**Pad Spaces To
Length 30**



Stop Pad Spaces

Pad Data with Zeros

To pad data to the left, scan the bar code containing the desired number of zeros. Send commands activate this parameter.



**Pad Zeros To
Length 1**



**Pad Zeros To
Length 2**



**Pad Zeros To
Length 3**

Pad Data with Zeros (Continued)



**Pad Zeros To
Length 4**



**Pad Zeros To
Length 5**



**Pad Zeros To
Length 6**

Pad Data with Zeros (Continued)



**Pad Zeros To
Length 7**



**Pad Zeros To
Length 8**



**Pad Zeros To
Length 9**

Pad Data with Zeros (Continued)



**Pad Zeros To
Length 10**



**Pad Zeros To
Length 11**



**Pad Zeros To
Length 12**

Pad Data with Zeros (Continued)



**Pad Zeros To
Length 13**



**Pad Zeros To
Length 14**



**Pad Zeros To
Length 15**

Pad Data with Zeros (Continued)



**Pad Zeros To
Length 16**



**Pad Zeros To
Length 17**



**Pad Zeros To
Length 18**

Pad Data with Zeros (Continued)



**Pad Zeros To
Length 19**



**Pad Zeros To
Length 20**



**Pad Zeros To
Length 21**

Pad Data with Zeros (Continued)



**Pad Zeros To
Length 22**



**Pad Zeros To
Length 23**



**Pad Zeros To
Length 24**

Pad Data with Zeros (Continued)



**Pad Zeros To
Length 25**



**Pad Zeros To
Length 26**



**Pad Zeros To
Length 27**

Pad Data with Zeros (Continued)



**Pad Zeros To
Length 28**



**Pad Zeros To
Length 29**



**Pad Zeros To
Length 30**



Stop Pad Zeros

Beeps

Select a beep sequence for each ADF rule.



Beep Once



Beep Twice



Beep Three Times

Send Keystroke (Control Characters and Keyboard Characters)

Control Characters

Scan a **Send** bar code for the keystroke to send.



Send Control 2



Send Control A

Control Characters (Continued)



Send Control B



Send Control C



Send Control D

Control Characters (Continued)



Send Control E



Send Control F



Send Control G

Control Characters (Continued)



Send Control H



Send Control I



Send Control J

Control Characters (Continued)



Send Control K



Send Control L



Send Control M

Control Characters (Continued)



Send Control N



Send Control O



Send Control P

Control Characters (Continued)



Send Control Q



Send Control R



Send Control S

Control Characters (Continued)



Send Control T



Send Control U



Send Control V

Control Characters (Continued)



Send Control W



Send Control X



Send Control Y

Control Characters (Continued)



Send Control Z



Send Control [



**Send Control **

Control Characters (Continued)



Send Control]



Send Control 6



Send Control -

Keyboard Characters

Scan a **Send** bar code for the keyboard characters to send.



Send Space



Send !



Keyboard Characters (Continued)



Send #



Send \$



Send %

Keyboard Characters (Continued)



Send &



Send ‘



Send (

Keyboard Characters (Continued)



Send)



Send *



Send +

Keyboard Characters (Continued)



Send ,

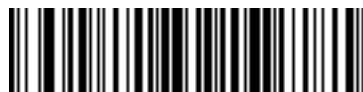

Send -



Send .

Keyboard Characters (Continued)



Send /



Send 0



Send 1

Keyboard Characters (Continued)



Send 2



Send 3



Send 4

Keyboard Characters (Continued)



Send 5



Send 6



Send 7

Keyboard Characters (Continued)



Send 8



Send 9



Send :

Keyboard Characters (Continued)



Send ;



Send <



Send =

Keyboard Characters (Continued)



Send >



Send ?



Send @

Keyboard Characters (Continued)



Send A



Send B



Send C

Keyboard Characters (Continued)



Send D



Send E



Send F

Keyboard Characters (Continued)



Send G



Send H



Send I

Keyboard Characters (Continued)



Send J



Send K



Send L

Keyboard Characters (Continued)



Send M



Send N



Send O

Keyboard Characters (Continued)



Send P



Send Q



Send R

Keyboard Characters (Continued)



Send S



Send T



Send U

Keyboard Characters (Continued)



Send V



Send W



Send X

Keyboard Characters (Continued)



Send Y



Send Z



Send [

Keyboard Characters (Continued)



**Send **



Send]



Send ^

Keyboard Characters (Continued)



Send _



Send ‘



Send a

Keyboard Characters (Continued)



Send b



Send c



Send d

Keyboard Characters (Continued)



Send e



Send f



Send g

Keyboard Characters (Continued)



Send h



Send i



Send j

Keyboard Characters (Continued)



Send k



Send l



Send m

Keyboard Characters (Continued)



Send n



Send o



Send p

Keyboard Characters (Continued)



Send q



Send r



Send s

Keyboard Characters (Continued)



Send t



Send u



Send v

Keyboard Characters (Continued)



Send w



Send x



Send y

Keyboard Characters (Continued)



Send z



Send {



Send |

Keyboard Characters (Continued)



Send }



Send ~

Send ALT Characters



Send Alt 2



Send Alt A



Send Alt B



Send Alt C

Send ALT Characters (Continued)



Send Alt D



Send Alt E



Send Alt F

Send ALT Characters (Continued)



Send Alt G



Send Alt H



Send Alt I

Send ALT Characters (Continued)



Send Alt J



Send Alt K



Send Alt L

Send ALT Characters (Continued)



Send Alt M



Send Alt N



Send Alt O

Send ALT Characters (Continued)



Send Alt P



Send Alt Q



Send Alt R

Send ALT Characters (Continued)



Send Alt S



Send Alt T



Send Alt U

Send ALT Characters (Continued)



Send Alt V



Send Alt W



Send Alt X



Send Alt Y

Send ALT Characters (Continued)



Send Alt Z



Send Alt [



**Send Alt **



Send Alt]

Send Keypad Characters



Send Keypad *



Send Keypad +



Send Keypad -

Send Keypad Characters (Continued)



Send Keypad .



Send Keypad /

Send Keypad Characters (Continued)



Send Keypad 0



Send Keypad 1



Send Keypad 2

Send Keypad Characters (Continued)



Send Keypad 3



Send Keypad 4



Send Keypad 5

Send Keypad Characters (Continued)



Send Keypad 6



Send Keypad 7



Send Keypad 8

Send Keypad Characters (Continued)



Send Keypad 9



Send Keypad Enter



**Send Keypad
Numlock**

Send Keypad Characters (Continued)



Send Break Key



Send Delete Key



Send Page Up Key

Send Keypad Characters (Continued)



Send End Key



Send Page Down Key



Send Pause Key

Send Keypad Characters (Continued)



Send Scroll Lock Key



Send Backspace Key



Send Tab Key

Send Keypad Characters (Continued)



Send Print Screen Key



Send Insert Key



Send Home Key

Send Keypad Characters (Continued)



Send Enter Key



Send Escape Key



Send Up Arrow Key

Send Keypad Characters (Continued)



Send Down Arrow Key



Send Left Arrow Key



Send Right Arrow Key



**Send Back Tab
Character**

Send Function Key



Send F1 Key



Send F2 Key

Send Function Key (Continued)



Send F3 Key



Send F4 Key



Send F5 Key

Send Function Key (Continued)



Send F6 Key



Send F7 Key



Send F8 Key

Send Function Key (Continued)



Send F9 Key



Send F10 Key



Send F11 Key

Send Function Key (Continued)



Send F12 Key



Send F13 Key



Send F14 Key

Send Function Key (Continued)



Send F15 Key



Send F16 Key



Send F17 Key

Send Function Key (Continued)



Send F18 Key



Send F19 Key



Send F20 Key

Send Function Key (Continued)



Send F21 Key



Send F22 Key



Send F23 Key

Send Function Key (Continued)



Send F24 Key



Send F25 Key



Send F26 Key

Send Function Key (Continued)



Send F27 Key



Send F28 Key



Send F29 Key

Send Function Key (Continued)



Send F30 Key



Send PF1 Key



Send PF2 Key

Send Function Key (Continued)



Send PF3 Key



Send PF4 Key



Send PF5 Key

Send Function Key (Continued)



Send PF6 Key



Send PF7 Key



Send PF8 Key

Send Function Key (Continued)



Send PF9 Key



Send PF10 Key



Send PF11 Key

Send Function Key (Continued)



Send PF12 Key



Send PF13 Key



Send PF14 Key

Send Function Key (Continued)



Send PF15 Key



Send PF16 Key



Send PF17 Key

Send Function Key (Continued)



Send PF18 Key



Send PF19 Key



Send PF20 Key

Send Function Key (Continued)



Send PF21 Key



Send PF22 Key



Send PF23 Key

Send Function Key (Continued)



Send PF24 Key



Send PF25 Key



Send PF26 Key

Send Function Key (Continued)



Send PF27 Key



Send PF28 Key



Send PF29 Key



Send PF30 Key

Send Right Control Key

The **Send Right Control Key** action sends a tap (press and release) of the Right Control Key.

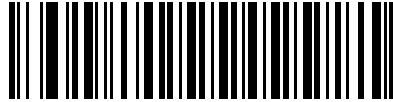

Send Right Control Key

Send Graphic User Interface Characters

The **Send Graphic User Interface Character** actions tap the specified key while holding the System Dependant Graphic User Interface (GUI) Key. The definition of the Graphic User Interface key depends on the attached system.

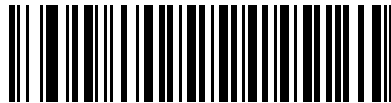

Send GUI 0

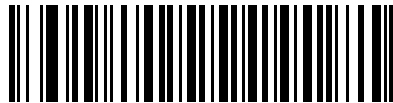

Send GUI 1



Send GUI 2

Send Graphic User Interface Characters (Continued)

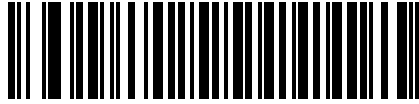

Send GUI 3

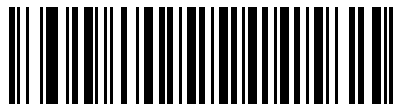

Send GUI 4



Send GUI 5

Send Graphic User Interface Characters (Continued)



Send GUI 6

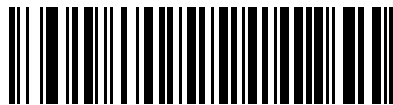

Send GUI 7

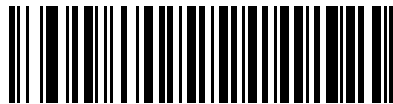

Send GUI 8

Send Graphic User Interface Characters (Continued)



Send GUI 9



Send GUI A



Send GUI B

Send Graphic User Interface Characters (Continued)

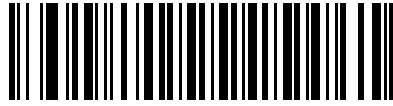

Send GUI C

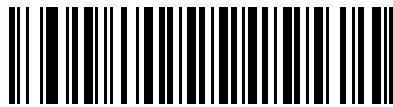

Send GUI D

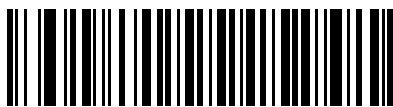

Send GUI E

Send Graphic User Interface Characters (Continued)

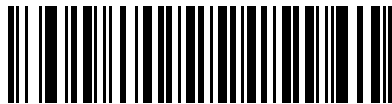

Send GUI F



Send GUI G



Send GUI H

Send Graphic User Interface Characters (Continued)



Send GUI I

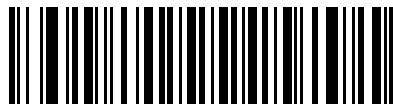

Send GUI J

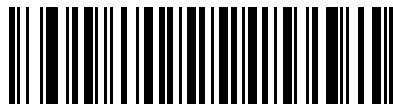

Send GUI K

Send Graphic User Interface Characters (Continued)



Send GUI L



Send GUI M



Send GUI N

Send Graphic User Interface Characters (Continued)



Send GUI O

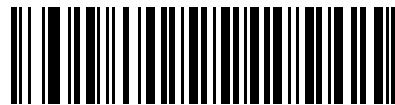

Send GUI P

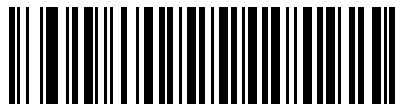

Send GUI Q

Send Graphic User Interface Characters (Continued)



Send GUI R



Send GUI S



Send GUI T

Send Graphic User Interface Characters (Continued)



Send GUI U

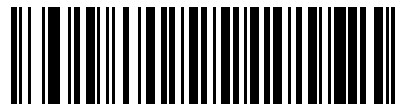

Send GUI V

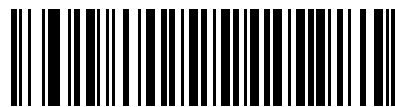

Send GUI W

Send Graphic User Interface Characters (Continued)



Send GUI X



Send GUI Y



Send GUI Z

Turn On/Off Rule Sets

Use these bar codes to turn rule sets on and off.



Turn On Rule Set 1



Turn On Rule Set 2

Turn On/Off Rule Sets (Continued)



Turn On Rule Set 3



Turn On Rule Set 4



Turn Off Rule Set 1

Turn On/Off Rule Sets (Continued)



Turn Off Rule Set 2



Turn Off Rule Set 3



Turn Off Rule Set 4

Alphanumeric Keyboard



Space



#



\$

Alphanumeric Keyboard (Continued)



%



*



+

Alphanumeric Keyboard (Continued)



-



.



,



/

Alphanumeric Keyboard (Continued)



!



“



&

Alphanumeric Keyboard (Continued)



'



(



)

Alphanumeric Keyboard (Continued)



:



;



<

Alphanumeric Keyboard (Continued)



=



>



?

Alphanumeric Keyboard (Continued)



@



[



\

Alphanumeric Keyboard (Continued)



1



2



3

Alphanumeric Keyboard (Continued)

Do not confuse bar codes on this page with those on the numeric keypad.



,



0



1

Alphanumeric Keyboard (Continued)

Do not confuse bar codes on this page with those on the numeric keypad.



2



3



4

Alphanumeric Keyboard (Continued)

Do not confuse bar codes on this page with those on the numeric keypad.



5



6



7

Alphanumeric Keyboard (Continued)

Do not confuse bar codes on this page with those on the numeric keypad.



8



9



A

Alphanumeric Keyboard (Continued)



B



C



D

Alphanumeric Keyboard (Continued)



E



F



G

Alphanumeric Keyboard (Continued)



H



I



J

Alphanumeric Keyboard (Continued)



K



L



M

Alphanumeric Keyboard (Continued)



N



O



P

Alphanumeric Keyboard (Continued)



Q



R



S

Alphanumeric Keyboard (Continued)



T



U



V

Alphanumeric Keyboard (Continued)



W



X



Y

Alphanumeric Keyboard (Continued)



Z



Cancel



End Of Message

Alphanumeric Keyboard (Continued)



a



b



c

Alphanumeric Keyboard (Continued)



d



e



f

Alphanumeric Keyboard (Continued)



g



h



i

Alphanumeric Keyboard (Continued)



j



k



l

Alphanumeric Keyboard (Continued)



m



n



o

Alphanumeric Keyboard (Continued)



p



q



r

Alphanumeric Keyboard (Continued)



s



t



u

Alphanumeric Keyboard (Continued)



v



w



x

Alphanumeric Keyboard (Continued)



y



z



{

Alphanumeric Keyboard (Continued)



|



}



~

Appendix A Standard Default Parameters

Table A-1 Standard Default Parameters Table

Parameter	Default	Page Number
User Preferences		
Set Default Parameter	Restore Defaults	4-3
Beeper Tone	High	4-4
Beeper Volume	High	4-5
Volume Change Trigger Delay	5 sec	4-6
Laser On Time	3.0 sec	4-7
Beep After Good Decode	Enable	4-7
Low Power Blink	Blink	4-8
Scan Pattern Mode	Rastering	4-9
Single-Line Aim Duration	2 sec	4-10
Time-out Between Same Symbol	0.6 sec (LS9208) 0.5 sec (LS9208i)	4-11
Time-out Between Different Symbols	0.2 sec	4-11
Time Delay to Low Power Mode	30 Minutes	4-12
Linear UPC/EAN Decode	Disable	4-13
Keyboard Wedge Host Parameters		
Keyboard Wedge Host Type	IBM PC/AT& IBM PC Compatibles ¹	5-4

¹User selection is required to configure this interface and this is the most common selection.

Table A-1 Standard Default Parameters Table (Continued)

Parameter	Default	Page Number
Country Types (Country Codes)	North American	5-5
Ignore Unknown Characters	Transmit	5-8
Keystroke Delay	No Delay	5-9
Inter-Keystroke Delay	Disable	5-10
Alternate Numeric Keypad Emulation	Disable	5-10
Caps Lock On	Disable	5-11
Caps Lock Override	Disable	5-11
Convert Wedge Data	No Convert	5-12
Function Key Mapping	Disable	5-13
FN1 Substitution	Disable	5-13
Send Make Break	Disable	5-14
RS-232 Host Parameters		
RS-232 Host Types	Standard ¹	6-6
Baud Rate	9600	6-8
Parity	None	6-10
Check Receive Errors	Enable	6-11
Hardware Handshaking	None	6-12
Software Handshaking	None	6-14
Host Serial Response Time-out	2 Sec	6-15
RTS Line State	Low RTS	6-17
Stop Bit Select	1	6-17
Data Bits	8-Bit	6-18
Beep on <BEL>	Disable	6-18
Intercharacter Delay	0 msec	6-19
Nixdorf Beep/LED Options	Normal Operation	6-20
Ignore Unknown Characters	Send Bar Codes	6-21
USB Host Parameters		

¹User selection is required to configure this interface and this is the most common selection.

Table A-1 Standard Default Parameters Table (Continued)

Parameter	Default	Page Number
USB Device Type	HID (Human Interface Device) Keyboard Emulation	7-4
USB Country Keyboard Types (Country Codes)	North American	7-6
USB Keystroke Delay	No Delay	7-9
USB CAPS Lock Override	Disable	7-10
USB Ignore Enable Transmission	Enable	7-10
Emulate Keypad	Disable	7-11
USB Keyboard FN1 Substitution	Disable	7-11
Function Key Mapping	Disable	7-12
Simulated Caps Lock	Disable	7-12
Convert Case	Disable	7-13
IBM 468X/469X Host Parameters		
Port Address	None Selected ¹	8-3
Convert Unknown Bar Code 39	Disable	8-4
Wand Emulation Host Parameters		
Wand Emulation Host Types	Symbol OmniLink Interface Controller ¹	9-4
Leading Margin	80 msec	9-5
Polarity	Bar High/Margin Low	9-6
Ignore Unknown Characters	Transmit	9-6
Convert All Bar Codes to Code 39	Disable	9-7
Convert Code 39 to Full ASCII	Disable	9-8
123Scan Configuration Tool		
123Scan	None ¹	10-1
UPC/EAN		
UPC-A	Enable	11-5
UPC-E	Enable	11-5
UPC-E1	Disable	11-6

¹User selection is required to configure this interface and this is the most common selection.

Table A-1 Standard Default Parameters Table (Continued)

Parameter	Default	Page Number
EAN-8/JAN-8	Enable	11-6
EAN-13/JAN-13	Enable	11-6
Bookland EAN	Disable	11-8
Decode UPC/EAN Supplementals (2 and 5 digits)	Ignore	11-9
User-Programmable Supplementals Supplemental 1: Supplemental 2:		11-13
Decode UPC/EAN Supplemental Redundancy	20	11-13
Transmit UPC-A Check Digit	Transmit	11-14
Transmit UPC-E Check Digit	Transmit	11-14
Transmit UPC-E1 Check Digit	Transmit	11-14
UPC-A Preamble	System Character	11-16
UPC-E Preamble	System Character	11-17
UPC-E1 Preamble	System Character	11-18
Convert UPC-E to A	Disable	11-19
Convert UPC-E1 to A	Disable	11-19
EAN-8 Zero Extend	Disable	11-20
Bookland ISBN Format	ISBN-10	11-21
UCC Coupon Extended Code	Disable	11-22
Code 128		
Code 128	Enable	11-23
GS1-128 (formerly UCC/EAN-128)	Enable	11-23
ISBT 128 (non-concatenated)	Enable	11-24
Code 128 Decode Performance	Enable	11-24
Code 128 Decode Performance Level	Level 3	11-25
Code 39		
Code 39	Enable	11-26
Trioptic Code 39	Disable	11-27

¹User selection is required to configure this interface and this is the most common selection.

Table A-1 Standard Default Parameters Table (Continued)

Parameter	Default	Page Number
Convert Code 39 to Code 32 (Italian Farmer Code)	Disable	11-28
Code 32 Prefix	Disable	11-28
Set Length(s) for Code 39	2 to 55	11-29
Code 39 Check Digit Verification	Disable	11-30
Transmit Code 39 Check Digit	Do Not Transmit	11-30
Code 39 Full ASCII Conversion	Disable	11-31
Buffer Code 39	Disable	11-31
Code 39 Decode Performance	Enable	11-34
Code 39 Decode Performance Level	Level 3	11-35
Code 93		
Code 93	Disable	11-36
Set Length(s) for Code 93	4 to 55	11-36
Code 11		
Code 11	Disable	11-38
Set Lengths for Code 11	4 to 55	11-38
Code 11 Check Digit Verification	Disable	11-40
Transmit Code 11 Check Digit	Do Not Transmit	11-41
Interleaved 2 of 5 (ITF)		
Interleaved 2 of 5 (ITF)	Disable	11-42
Set Length(s) for I 2 of 5	14	11-42
I 2 of 5 Check Digit Verification	Disable	11-44
Transmit I 2 of 5 Check Digit	Do Not Transmit	11-45
Convert I 2 of 5 to EAN 13	Disable	11-45
Discrete 2 of 5 (DTF)		
Discrete 2 of 5	Disable	11-46
Set Length(s) for D 2 of 5	12	11-46
Chinese 2 of 5		
Enable/Disable Chinese 2 of 5	Disable	11-48

¹User selection is required to configure this interface and this is the most common selection.

Table A-1 Standard Default Parameters Table (Continued)

Parameter	Default	Page Number
Codabar (NW - 7)		
Codabar	Disable	11-48
Set Lengths for Codabar	5 to 55	11-49
CLSI Editing	Disable	11-50
NOTIS Editing	Disable	11-50
MSI		
MSI	Disable	11-51
Set Length(s) for MSI	4 to 55	11-51
MSI Check Digits	One	11-53
Transmit MSI Check Digit	Disable	11-53
MSI Check Digit Algorithm	Mod 10/Mod 10	11-54
GS1 DataBar (formerly RSS, Reduced Space Symbology)		
GS1 DataBar-14	Enable (LS9208) Disable (LS9208i)	11-55
GS1 DataBar Limited	Disable	11-56
GS1 DataBar Expanded	Enable (LS9208) Disable (LS9208i)	11-56
Convert GS1 DataBar to UPC/EAN	Disable	11-57
Symbology - Specific Security Levels		
Redundancy Security Levels	1	11-59
Security Level	0	11-61
Symbology - Intercharacter Gap		
Intercharacter Gaps	Normal	11-62
Miscellaneous Scanner Options		
Transmit Code ID Character	Disable	12-3
Suffix Value (Value 1)	<CR><LF>	12-4
Prefix Value (Value 2)	None	12-4

¹User selection is required to configure this interface and this is the most common selection.

Table A-1 Standard Default Parameters Table (Continued)

Parameter	Default	Page Number
FN1 Substitution Values	7013	12-5
Scan Data Options	Data as is	12-6
Transmit "No Read" Message	Disable	12-8
Report Version		12-9
Report MIMIC Version		12-9
Report Synapse Cable		12-9

¹User selection is required to configure this interface and this is the most common selection.

Appendix B Programming Reference

Symbol Code Identifiers

Table B-1 *Symbol Code Characters*

Code Character	Code Type
A	UPC/EAN
B	Code 39, Code 39 Full ASCII, Code 32
C	Codabar
D	Code 128, ISBT 128
E	Code 93
F	Interleaved 2 of 5
G	Discrete 2 of 5, IATA
H	Code 11
J	MSI
K	GS1-128 (formerly UCC/EAN-128)
L	Bookland EAN
M	Code 39 Trioptic
N	Coupon Code
R	GS1 DataBar

AIM Code Identifiers

Each AIM Code Identifier contains the three-character string **Jcm** where:

- J = Flag Character (ASCII 93)
- c = Code Character
- m = Modifier Character

Table B-2 AIM Code Characters

Code Character	Code Type
A	Code 39, Code 39 Full ASCII, Code 32
C	Code 128 (all variants), Coupon (Code 128 portion)
E	UPC/EAN, Coupon (UPC/EAN portion)
F	Codabar
G	Code 93
H	Code 11
I	Interleaved 2 of 5
M	MSI
S	Discrete 2 of 5, IATA
X	Bookland EAN, Trioptic Code 39
e	GS1 DataBar

The modifier character is the sum of the applicable option values based on [Table B-3](#).

Table B-3 *Modifier Characters*

Code Type	Option Value	Option
Code 39		
	0	No Check character.
	1	Reader has checked one check character.
	3	Reader has checked and stripped check character.
	4	Reader has performed Full ASCII character conversion.
	5	Reader has performed Full ASCII character conversion and checked one check character.
	7	Reader has performed Full ASCII character conversion and checked and stripped check character.
	Example: A Full ASCII bar code with check character W, A+I+MI+DW , is transmitted as JA7 AimId where 7 = (3+4).	
Trioptic Code 39		
	0	No option specified at this time. Always transmit 0.
	Example: A Trioptic bar code 412356 is transmitted as JX0 412356	
Code 128		
	0	Standard data packet, No Function code 1 in first symbol position.
	1	Function code 1 in first symbol character position.
	2	Function code 1 in second symbol character position.
	Example: A Code (EAN) 128 bar code with Function 1 character in the first position, FNC1 Aim Id is transmitted as JC1 AimId	
I 2 of 5		
	0	No check digit processing.
	1	Reader has validated check digit.
	3	Reader has validated and stripped check digit.
	Example: An I 2 of 5 bar code without check digit, 4123, is transmitted as JIO 4123	
Codabar		
	0	Standard Codabar
	1	ABC Codabar
	Example: A standard Codabar bar code, 4123, is transmitted as JF0 4123	

Table B-3 *Modifier Characters*

Code Type	Option Value	Option
Code 93		
	0	No options specified at this time. Always transmit 0.
		Example: A Code 93 bar code 012345678905 is transmitted as JG00 12345678905
MSI		
	0	Mod 10 check digit validated and transmitted.
	1	Mod 10 check digit validated but not transmitted.
		Example: An MSI Plessey bar code 4123, with Mod 10 check digit validated, is transmitted as JM0 4123
D 2 of 5		
	0	No options specified at this time. Always transmit 0.
		Example: A D 2 of 5 bar code 4123, is transmitted as JS0 4123
UPC/EAN		
	0	Standard packet in full EAN country code format, which is 13 digits for UPC-A, UPC-E, and EAN-13 (not including supplemental data).
	1	Two digit supplement data only.
	2	Five digit supplement data only.
	3	Combined data packet comprising 13 digits from a UPC-A, UPC-E, or EAN-13 symbol and 2 or 5 digits from a supplemental symbol.
	4	EAN-8 data packet.
		Example: A UPCA bar code 012345678905 is transmitted as JE000 12345678905
Bookland EAN		
	0	No options specified at this time. Always transmit 0.
		Example: A Bookland EAN bar code 123456789X is transmitted as JX0 123456789X
Code 11		
	0	Single check digit.
	1	Two check digits.
	3	Check characters validated but not transmitted.

Table B-3 *Modifier Characters*

Code Type	Option Value	Option
GS1 DataBar Family		
		No option specified at this time. Always transmit 0. GS1 DataBar-14 and GS1 DataBar Limited transmit with an Application Identifier "01". Note: In GS1-128 (formerly UCC/EAN-128) emulation mode, GS1 DataBar is transmitted using Code 128 rules (i.e.,]C1).
		Example: A GS1 DataBar-14 bar code 100123456788902 is transmitted as]e001100123456788902.

Appendix C Sample Bar Codes

Code 39



UPC/EAN

UPC-A, 100 %



EAN-13, 100 %



Code 128



Interleaved 2 of 5



12345678901231

GS1 DataBar-14

✓ **NOTE** GS1 DataBar-14 must be enabled to read the bar code below (see [GS1 DataBar-14 on page 11-55](#)).



Appendix D Numeric Bar Codes

0, 1

For parameters requiring specific numeric values, scan the appropriately numbered bar code(s).



0

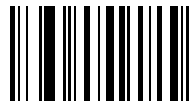

1

2, 3, 4, 5



6, 7, 8, 9



6

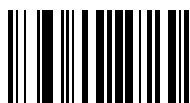

7



8



9

Cancel

To correct an error or change a selection, scan the bar code below.



Cancel

Glossary

A

Aperture. The opening in an optical system defined by a lens or baffle that establishes the field of view.

ASCII. American Standard Code for Information Interchange. A 7 bit-plus-parity code representing 128 letters, numerals, punctuation marks and control characters. It is a standard data transmission code in the U.S.

Autodiscrimination. The ability of an interface controller to determine the code type of a scanned bar code. After this determination is made, the information content is decoded.

B

Bar. The dark element in a printed bar code symbol.

Bar Code. A pattern of variable-width bars and spaces which represents numeric or alphanumeric data in machine-readable form. The general format of a bar code symbol consists of a leading margin, start character, data or message character, check character (if any), stop character, and trailing margin. Within this framework, each recognizable symbology uses its own unique format. See **Symbology**.

Bar Code Density. The number of characters represented per unit of measurement (e.g., characters per inch).

Bar Height. The dimension of a bar measured perpendicular to the bar width.

Bar Width. Thickness of a bar measured from the edge closest to the symbol start character to the trailing edge of the same bar.

Bit. Binary digit. One bit is the basic unit of binary information. Generally, eight consecutive bits compose one byte of data. The pattern of 0 and 1 values within the byte determines its meaning.

Bits per Second (bps). Bits transmitted or received.

Bluetooth. A technology that provides a way to connect and exchange information between devices such as scanners, mobile phones, laptops, PCs, and printers over a secure, globally unlicensed short-range radio frequency.

Boot or Boot-up. The process a computer goes through when it starts. During boot-up, the computer can run self-diagnostic tests and configure hardware and software.

bps. See **Bits Per Second**.

Byte. On an addressable boundary, eight adjacent binary digits (0 and 1) combined in a pattern to represent a specific character or numeric value. Bits are numbered from the right, 0 through 7, with bit 0 the low-order bit. One byte in memory is used to store one ASCII character.

C

CDRH. Center for Devices and Radiological Health. A federal agency responsible for regulating laser product safety. This agency specifies various laser operation classes based on power output during operation.

CDRH Class 1. This is the lowest power CDRH laser classification. This class is considered intrinsically safe, even if all laser output were directed into the eye's pupil. There are no special operating procedures for this class.

CDRH Class 2. No additional software mechanisms are needed to conform to this limit. Laser operation in this class poses no danger for unintentional direct human exposure.

Character. A pattern of bars and spaces which either directly represents data or indicates a control function, such as a number, letter, punctuation mark, or communications control contained in a message.

Character Set. Those characters available for encoding in a particular bar code symbology.

Check Digit. A digit used to verify a correct symbol decode. The scanner inserts the decoded data into an arithmetic formula and checks that the resulting number matches the encoded check digit. Check digits are required for UPC but are optional for other symbologies. Using check digits decreases the chance of substitution errors when a symbol is decoded.

Codabar. A discrete self-checking code with a character set consisting of digits 0 to 9 and six additional characters: (- \$: / , +).

Code 128. A high density symbology which allows the controller to encode all 128 ASCII characters without adding extra symbol elements.

Code 3 of 9 (Code 39). A versatile and widely used alphanumeric bar code symbology with a set of 43 character types, including all uppercase letters, numerals from 0 to 9 and 7 special characters (- . / + % \$ and space). The code name is derived from the fact that 3 of 9 elements representing a character are wide, while the remaining 6 are narrow.

Code 93. An industrial symbology compatible with Code 39 but offering a full character ASCII set and a higher coding density than Code 39.

Code Length. Number of data characters in a bar code between the start and stop characters, not including those characters.

Cold Boot. A cold boot restarts a computer and closes all running programs.

COM Port. Communication port; ports are identified by number, e.g., COM1, COM2.

Continuous Code. A bar code or symbol in which all spaces within the symbol are parts of characters. There are no intercharacter gaps in a continuous code. The absence of gaps allows for greater information density.

Cradle. A cradle is used for charging the terminal battery and for communicating with a host computer, and provides a storage place for the terminal when not in use.

D

Dead Zone. An area within a scanner's field of view, in which specular reflection may prevent a successful decode.

Decode. To recognize a bar code symbology (e.g., UPC/EAN) and then analyze the content of the specific bar code scanned.

Decode Algorithm. A decoding scheme that converts pulse widths into data representation of the letters or numbers encoded within a bar code symbol.

Decryption. Decryption is the decoding and unscrambling of received encrypted data. Also see, **Encryption** and **Key**.

Depth of Field. The range between minimum and maximum distances at which a scanner can read a symbol with a certain minimum element width.

Discrete Code. A bar code or symbol in which the spaces between characters (intercharacter gaps) are not part of the code.

Discrete 2 of 5. A binary bar code symbology representing each character by a group of five bars, two of which are wide. The location of wide bars in the group determines which character is encoded; spaces are insignificant. Only numeric characters (0 to 9) and START/STOP characters may be encoded.

E

EAN. European Article Number. This European/International version of the UPC provides its own coding format and symbology standards. Element dimensions are specified metrically. EAN is used primarily in retail.

Element. Generic term for a bar or space.

Encoded Area. Total linear dimension occupied by all characters of a code pattern, including start/stop characters and data.

ENQ (RS-232). ENQ software handshaking is also supported for the data sent to the host.

ESD. Electro-Static Discharge

H

HID. Human Interface Device. A Bluetooth host type.

Host Computer. A computer that serves other terminals in a network, providing such services as computation, database access, supervisory programs and network control.

Hz. Hertz; A unit of frequency equal to one cycle per second.

I

IEC. International Electrotechnical Commission. This international agency regulates laser safety by specifying various laser operation classes based on power output during operation.

IEC (825) Class 1. This is the lowest power IEC laser classification. Conformity is ensured through a software restriction of 120 seconds of laser operation within any 1000 second window and an automatic laser shutdown if the scanner's oscillating mirror fails.

Intercharacter Gap. The space between two adjacent bar code characters in a discrete code.

Interleaved 2 of 5. A binary bar code symbology representing character pairs in groups of five bars and five interleaved spaces. Interleaving provides for greater information density. The location of wide elements (bar/spaces) within each group determines which characters are encoded. This continuous code type uses no intercharacter spaces. Only numeric (0 to 9) and START/STOP characters may be encoded.

Interleaved Bar Code. A bar code in which characters are paired together, using bars to represent the first character and the intervening spaces to represent the second.

Input/Output Ports. I/O ports are primarily dedicated to passing information into or out of the terminal's memory. Series 9000 mobile computers include Serial and USB ports.

I/O Ports. interface The connection between two devices, defined by common physical characteristics, signal characteristics, and signal meanings. Types of interfaces include RS-232 and PCMCIA.

K

Key. A key is the specific code used by the algorithm to encrypt or decrypt the data. Also see, **Encryption** and **Decrypting**.

L

LASER. Light Amplification by Stimulated Emission of Radiation. The laser is an intense light source. Light from a laser is all the same frequency, unlike the output of an incandescent bulb. Laser light is typically coherent and has a high energy density.

Laser Diode. A gallium-arsenide semiconductor type of laser connected to a power source to generate a laser beam. This laser type is a compact source of coherent light.

Laser Scanner. A type of bar code reader that uses a beam of laser light.

LED Indicator. A semiconductor diode (LED - Light Emitting Diode) used as an indicator, often in digital displays. The semiconductor uses applied voltage to produce light of a certain frequency determined by the semiconductor's particular chemical composition.

Light Emitting Diode. See **LED**.

M

MIL. 1 mil = 1 thousandth of an inch.

MIN. Mobile Identification Number. The unique account number associated with a cellular device. It is broadcast by the cellular device when accessing the cellular system.

Misread (Misdecode). A condition which occurs when the data output of a reader or interface controller does not agree with the data encoded within a bar code symbol.

MRD. Minimum reflective difference. A measurement of print contrast.

N

Nominal. The exact (or ideal) intended value for a specified parameter. Tolerances are specified as positive and negative deviations from this value.

Nominal Size. Standard size for a bar code symbol. Most UPC/EAN codes are used over a range of magnifications (e.g., from 0.80 to 2.00 of nominal).

O

ODI. See **Open Data-Link Interface**.

Open Data-Link Interface (ODI). Novell's driver specification for an interface between network hardware and higher-level protocols. It supports multiple protocols on a single NIC (Network Interface Controller). It is capable of understanding and translating any network information or request sent by any other ODI-compatible protocol into something a NetWare client can understand and process.

Open System Authentication. Open System authentication is a null authentication algorithm.

P

PAN . Personal area network. Using Bluetooth wireless technology, PANs enable devices to communicate wirelessly. Generally, a wireless PAN consists of a dynamic group of less than 255 devices that communicate within about a 33-foot range. Only devices within this limited area typically participate in the network.

Parameter. A variable that can have different values assigned to it.

Percent Decode. The average probability that a single scan of a bar code would result in a successful decode. In a well-designed bar code scanning system, that probability should approach near 100%.

Print Contrast Signal (PCS). Measurement of the contrast (brightness difference) between the bars and spaces of a symbol. A minimum PCS value is needed for a bar code symbol to be scannable. $PCS = (RL - RD) / RL$, where RL is the reflectance factor of the background and RD the reflectance factor of the dark bars.

Programming Mode. The state in which a scanner is configured for parameter values. See **Scanning Mode**.

Q

Quiet Zone. A clear space, containing no dark marks, which precedes the start character of a bar code symbol and follows the stop character.

QWERTY. A standard keyboard commonly used on North American and some European PC keyboards. "QWERTY" refers to the arrangement of keys on the left side of the third row of keys.

R

Reflectance. Amount of light returned from an illuminated surface.

Resolution. The narrowest element dimension which is distinguished by a particular reading device or printed with a particular device or method.

RF. Radio Frequency.

RS-232. An Electronic Industries Association (EIA) standard that defines the connector, connector pins, and signals used to transfer data serially from one device to another.

S

Scan Area. Area intended to contain a symbol.

Scanner. An electronic device used to scan bar code symbols and produce a digitized pattern that corresponds to the bars and spaces of the symbol. Its three main components are: 1) Light source (laser or photoelectric cell) - illuminates a bar code;; 2) Photodetector - registers the difference in reflected light (more light reflected from spaces); 3) Signal conditioning circuit - transforms optical detector output into a digitized bar pattern.

Scanning Mode. The scanner is energized, programmed and ready to read a bar code.

Scanning Sequence. A method of programming or configuring parameters for a bar code reading system by scanning bar code menus.

Self-Checking Code. A symbology that uses a checking algorithm to detect encoding errors within the characters of a bar code symbol.

Space. The lighter element of a bar code formed by the background between bars.

Specular Reflection. The mirror-like direct reflection of light from a surface, which can cause difficulty decoding a bar code.

SPP. Serial Port Profile.

Start/Stop Character. A pattern of bars and spaces that provides the scanner with start and stop reading instructions and scanning direction. The start and stop characters are normally to the left and right margins of a horizontal code.

Substrate. A foundation material on which a substance or image is placed.

Symbol. A scannable unit that encodes data within the conventions of a certain symbology, usually including start/stop characters, quiet zones, data characters and check characters.

Symbol Aspect Ratio. The ratio of symbol height to symbol width.

Symbol Height. The distance between the outside edges of the quiet zones of the first row and the last row.

Symbol Length. Length of symbol measured from the beginning of the quiet zone (margin) adjacent to the start character to the end of the quiet zone (margin) adjacent to a stop character.

Symbology. The structural rules and conventions for representing data within a particular bar code type (e.g. UPC/EAN, Code 39, PDF417, etc.).

T

Tolerance. Allowable deviation from the nominal bar or space width.

U

UPC. Universal Product Code. A relatively complex numeric symbology. Each character consists of two bars and two spaces, each of which is any of four widths. The standard symbology for retail food packages in the United States.

V

Visible Laser Diode (VLD). A solid state device which produces visible laser light.

Index

Numerics

123Scan parameters 10-1

A

actions 13-2

ADF 13-1

actions 13-1, 13-28, 13-29

move cursor 13-38, 13-39

send data 13-29

alphanumeric keyboard 13-170, 13-171

alternate rule sets 13-3

bar code menu example 13-2

beep 13-70

code lengths 13-16

code types 13-10

criteria 13-1, 13-10

default rules 13-5

move cursor past a character 13-36

move cursor past string 13-36

move cursor to a character 13-36

move cursor to last occurrence
of string and replace 13-36

move cursor to start of data 13-36

move cursor to string and replace 13-36

pad spaces 13-49

pad zeros 13-60, 13-61, 13-62

rules 13-1

rules hierarchy 13-4

send control characters 13-71

send function key 13-135

send keyboard characters 13-82, 13-83, 13-84

send keypad characters 13-123

send preset value 13-37

send value 13-46, 13-47

skip ahead "n" characters 13-37

skip ahead characters 13-40, 13-41, 13-42

skip back "n" characters 13-37

skip back characters 13-43, 13-45, 13-46

skip cursor to end 13-36

space removal 13-48

special commands 13-6

specific data string 13-26

specific string

any location 13-26

any message ok 13-27

at start 13-26

rule belongs to set 13-27, 13-28

search 13-27

turn off rule sets 13-167, 13-168, 13-169

zero removal 13-48

advanced data formatting 13-1

actions 13-1, 13-28

alphanumeric keyboard 13-170, 13-171

alternate rule sets 13-3

bar code menu example 13-2

beep 13-70

code lengths 13-16

code types 13-10

criteria 13-1, 13-10

default rules 13-5

pad spaces 13-49

pad zeros 13-60, 13-61, 13-62

rules 13-1

rules hierarchy 13-4

send control characters 13-71

send function key 13-135

send keyboard characters 13-82, 13-83, 13-84

send keypad characters 13-123

send preset value 13-46, 13-47

skip ahead characters 13-40, 13-41, 13-42

skip back characters 13-43, 13-45, 13-46

space removal 13-48

special commands	13-6
specific data string	13-26
turn off rule sets	13-167, 13-168, 13-169
zero removal	13-48
AIM code identifiers	B-2
aiming	2-8, 2-9
ASCII values	6-22

B

bar codes

123Scan	10-1
beep after good decode	4-7
beeper tone	4-4
beeper volume	4-5
bookland EAN	11-8
bookland ISBN	11-21
buffering	11-31
chinese 2 of 5	11-48
codabar	11-48
codabar CLSI editing	11-50
codabar lengths	11-49
codabar NOTIS editing	11-50
code 11	11-38
code 11 check digit verification	11-40
code 11 check digits	11-41
code 11 lengths	11-38
code 128	11-23
code 128 decode performance	11-24
code 128 decode performance level	11-25
code 32 prefix	11-28
code 39	11-26
code 39 check digit verification	11-30
code 39 decode performance	11-34
code 39 decode performance level	11-35
code 39 full ASCII	11-31
code 39 lengths	11-29
code 39 transmit buffer	11-33
code 39 transmit check digit	11-30
code 93	11-36
code 93 lengths	11-36
convert code 39 to code 32	11-28
convert GS1 DataBar to UPC/EAN	11-57
convert UPC-E to UPC-A	11-19
convert UPC-E1 to UPC-A	11-19
data options	12-3
pause duration	13-6
prefix/suffix values	12-4
transmit code ID character	12-3
discrete 2 of 5	11-46
discrete 2 of 5 lengths	11-46
EAN zero extend	11-20
EAN-13/EAN-8	11-7
EAN-8	11-7
GS1 DataBar	11-55
GS1 DataBar expanded	11-56
GS1 DataBar limited	11-56
GS1 DataBar-14	11-55
GS1-128	11-23
I 2 of 5 check digit verification	11-44
I 2 of 5 convert to EAN-13	11-45
I 2 of 5 transmit check digit	11-45
IBM 468X/469X	
convert unknown to code 39	8-4
default parameters	8-2
port address	8-3
intercharacter gap	11-62
interleaved 2 of 5	11-42
interleaved 2 of 5 lengths	11-42
ISBT 128	11-24
keyboard wedge	
alternate numeric keypad emulation	5-10
caps lock on	5-11
caps lock override	5-11
country keyboard types (country codes)	5-5
default table	5-3
host types	5-4
ignore unknown characters	5-8
intra-keystroke delay	5-10
keystroke delay	5-9
laser on time	4-7
miscellaneous	
scan data options	12-6
transmit no read msg	12-8
MSI	11-51
MSI check digit algorithm	11-54
MSI check digits	11-53
MSI lengths	11-51, 11-52
MSI transmit check digit	11-53
numeric bar codes	D-4
redundancy level	11-59
report mimic version	12-9
report synapse cable	12-9
report version	12-9
RS-232	
ASCII format	6-18
baud rate	6-8
beep on bel	6-18
check receive errors	6-11
default table	6-3
hardware handshaking	6-12
host serial response time-out	6-15, 6-16
host types	6-6
intercharacter delay	6-19
parity	6-10
RTS line state	6-17
software handshaking	6-14
stop bit select	6-17

- security level 11-61
 - set defaults 4-3
 - supplementals 11-9
 - symbologies
 - default table 11-2
 - trioptic code 39 11-27
 - UCC coupon extended code 11-22
 - UPC/EAN
 - coupon code 11-22
 - UPC/EAN supp redundancy 11-13
 - UPC-A preamble 11-16
 - UPC-A/E/E1 check digit 11-14
 - UPC-A/UPC-E 11-5
 - UPC-E 11-5
 - UPC-E preamble 11-17
 - UPC-E1 11-6
 - UPC-E1 preamble 11-18
 - USB
 - caps lock override 7-10
 - country keyboard types 7-6
 - default table 7-3
 - device type 7-4
 - keystroke delay 7-9
 - unknown characters 7-10
 - wand emulation
 - code 39 full ASCII 9-8
 - convert all bar codes to code 39 9-7
 - default table 9-3
 - host types 9-4
 - leading margin (quiet zone) 9-5
 - polarity 9-6
 - unknown characters 9-6
 - bullets x
- C**
- cables
 - installing 1-2
 - interface 1-3
 - removing cables 1-5
 - character set 6-22
 - chinese 2 of 5 11-48
 - codabar 11-48
 - CLSI editing 11-50
 - lengths 11-49
 - NOTIS editing 11-50
 - code 11 11-38
 - check digit verification 11-40
 - lengths 11-38
 - transmit check digits 11-41
 - code 128 11-23
 - decode performance 11-24
 - decode performance level 11-25
 - GS1-128 11-23
 - ISBT 128 11-24
 - code 39 11-26
 - buffering 11-31
 - check digit verification 11-30
 - code 32 prefix 11-28
 - convert to code 32 11-28
 - decode performance 11-34
 - decode performance level 11-35
 - full ASCII 11-31
 - lengths 11-29
 - transmit buffer 11-33
 - transmit check digit 11-30
 - trioptic 11-27
 - code 93 11-36
 - lengths 11-36
 - code ID characters
 - AIM B-2
 - code identifiers
 - Symbol code IDs B-1
 - code types
 - ADF 13-10
 - connecting power 1-3
 - conventions
 - notational x
- D**
- decode zone
 - LS9208 2-9
 - LS9208i 2-10
 - default parameters 4-2
 - IBM 468X/469X 8-2
 - keyboard wedge 5-3
 - miscellaneous scanner options 12-2
 - RS-232 6-3
 - standard default table A-1
 - symbologies 11-2
 - USB 7-3
 - user preferences 4-2
 - wand emulation 9-3
 - discrete 2 of 5 11-46
 - lengths 11-46
- G**
- GS1 DataBar 11-55
 - convert to UPC/EAN 11-57
 - GS1 DataBar expanded 11-56
 - GS1 DataBar limited 11-56
 - GS1 DataBar-14 11-55
- H**
- host types

keyboard wedge 5-4
 RS-232 6-6
 wand emulation 9-4

I

IBM 468X/469X connection 8-2
 IBM 468X/469X default parameters 8-2
 IBM 468X/469X parameters 8-3
 information, servicexi
 intercharacter gap 11-62
 interleaved 2 of 5 11-42
 check digit verification 11-44
 convert to EAN-13 11-45
 lengths 11-42
 transmit check digit 11-45

K

keyboard wedge connection 5-2
 keyboard wedge default parameters 5-3
 keyboard wedge parameters 5-4

M

maintenance 3-1
 miscellaneous scanner parameters 12-2
 mounting template 2-12
 MSI 11-51
 check digit algorithm 11-54
 check digits 11-53
 lengths 11-51, 11-52
 transmit check digit 11-53

N

notational conventions x

P

parameters
 IBM 468X/469X 8-3
 keyboard wedge 5-4
 RS-232 6-4
 set defaults 4-3
 USB 7-4
 user preferences 4-3
 wand emulation 9-4
 pinouts
 scanner signal descriptions 3-5
 power supply
 connecting 1-3
 prefix/suffix values 6-22
 programming bar codes

time delay to low power mode 4-12, 4-13
 timeout between decodes 4-11

Q

quiet zone (leading margin) 9-5

R

report mimic version 12-9
 report synapse cable 12-9
 report version 12-9
 RS-232 connection 6-2
 RS-232 default parameters 6-3
 RS-232 parameters 6-4, 6-6

S

scanner defaults 4-2
 scanning
 aiming 2-8, 2-9
 errors 4-2, 11-1, 12-1
 hand-held 2-8
 presentation 2-3
 sequence example 4-1, 11-1, 12-1
 security
 redundancy level 11-59
 security level 11-61
 service information xi
 setup
 connecting a USB interface 7-2
 connecting an RS-232 interface 6-2
 connecting interface cable 1-3
 connecting keyboard wedge interface 5-2
 connecting power 1-3
 connecting power supply 1-3
 connecting to an IBM 468X/469X host 8-2
 connecting using wand emulation 9-2
 installing the cable 1-2
 unpacking 1-2
 signal descriptions 3-5
 specifications 3-3
 standard default parameters A-1
 standard defaults 4-2
 symbology default parameters 11-2

T

technical specifications 3-3
 template, stand mounting 2-12

U

unpacking 1-2

UPC/EAN

bookland EAN	11-8
bookland ISBN	11-21
check digit	11-14
convert UPC-E to UPC-A	11-19
convert UPC-E1 to UPC-A	11-19
EAN zero extend	11-20
EAN-13/EAN-8	11-7
EAN-8	11-7
supplemental redundancy	11-13
supplementals	11-9
UCC coupon extended code	11-22
UPC-A preamble	11-16
UPC-A/UPC-E	11-5
UPC-E	11-5
UPC-E preamble	11-17
UPC-E1	11-6
UPC-E1 preamble	11-18
USB connection	7-2
USB default parameters	7-3
USB parameters	7-4
user preferences bar codes	
set defaults	4-3
user preferences parameters	4-2, 4-3

W

wand emulation connection	9-2
wand emulation default parameters	9-3
wand emulation parameters	9-4

Tell Us What You Think...

We'd like to know what you think about this Manual. Please take a moment to fill out this questionnaire and fax this form to: (631) 738-4618, or mail to:

Motorola, Inc.
One Motorola Plaza M/S B-10
Holtsville, NY 11742-1300
Attention: Technical Publications Manager
Advanced Data Capture Division

IMPORTANT: If you need product support, please call the appropriate customer support number provided. Unfortunately, we cannot provide customer support at the fax number above.

Manual Title: _____
(please include revision level)

How familiar were you with this product before using this manual?

- Very familiar Slightly familiar Not at all familiar

Did this manual meet your needs? If not, please explain.

What topics need to be added to the index, if applicable?

What topics do you feel need to be better discussed? Please be specific.

What can we do to further improve our manuals?

Thank you for your input—We value your comments.



MOTOROLA

Motorola, Inc.
One Motorola Plaza
Holtsville, New York 11742, USA
1-800-927-9626
<http://www.motorolasolutions.com>

MOTOROLA and the Stylized M Logo and Symbol and the Symbol logo are registered in the U.S. Patent and Trademark Office.
All other product or service names are the property of their respective owners.
© Motorola, Inc. 2008

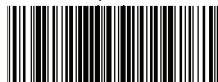

72E-60833-08 Revision A - February 2012